

Logic panel

# LP Series

## Instruction Manual





# Preface





Thank you very much for selecting Autonics products.

This user manual contains information about the product and its proper use, and should be kept in a place where it will be easy to access.

# LP series Instruction Manual Guide

- Please familiarize yourself with the information in this manual before using the product.
- This manual provides detailed information on the product's features. It does not offer any guarantee concerning matters beyond the scope of this manual.
- This manual may not be edited or reproduced in either part or whole without permission.
- This programming manual is not provided as part of the product package. Please visit our home-page ([www.autonics.com](http://www.autonics.com)) to download a copy.
- The manual's content may vary depending on changes to the product's software and other unforeseen developments within Autonics, and is subject to change without prior notice. Upgrade notice is provided through our homepage.
- We contrived to describe this manual more easily and correctly. However, if there are any corrections or questions, please notify us these on our homepage.

# LP series Instruction Manual Symbols

Symbol	Description
 <b>Note</b>	Supplementary information for a particular feature.
 <b>Warning</b>	Failure to follow instructions can result in serious injury or death.
 <b>Caution</b>	Failure to follow instructions can lead to a minor injury or product damage.
 <b>Ex.</b>	An example of the concerned feature's use.
※1	Annotation mark.

※The specifications and dimensions of this manual are subject to change without any notice.

# Table of Contents

	Preface .....	iii
	LP series Instruction Manual Guide .....	iv
	LP series Instruction Manual Symbols .....	v
	Table of Contents .....	vi
<b>1</b>	<b>Structures of instruction name .....</b>	<b>13</b>
1.1	Structure by data type .....	13
1.2	Structure by data processing .....	14
<b>2</b>	<b>Instruction .....</b>	<b>15</b>
2.1	Basic instruction list .....	15
2.1.1	Non processing instruction .....	15
2.1.2	Contact instruction .....	15
2.1.3	Output instruction .....	16
2.1.4	Reversal instruction .....	16
2.1.5	Stack instruction .....	17
2.1.6	Exit instruction .....	17
2.2	Application instruction .....	18
2.2.1	Counter instruction .....	18
2.2.2	Timer instruction .....	18
2.2.3	Control instruction .....	18
2.2.4	Branch instruction .....	19
2.2.5	Loop instruction .....	19
2.2.6	Master control instruction .....	19
2.2.7	Interrupt instruction .....	19
2.2.8	Watchdog timer .....	20
2.2.9	Input comparison instruction .....	20
2.2.10	Comparison instruction .....	23
2.2.11	Transmission instruction .....	23
2.2.12	Exchange instruction .....	24
2.2.13	Rotation instruction .....	25
2.2.14	Movement instruction .....	26
2.2.15	Arithmetic operation instruction .....	26
2.2.16	Logical operation instruction .....	30
2.2.17	BIN/BCD instruction .....	31
2.2.18	String conversion instruction .....	32
2.2.19	Code conversion instruction .....	33
2.2.20	Sign reversal instruction .....	33
2.2.21	Data conversion instruction .....	33
2.2.22	Refresh instruction .....	33
2.2.23	Display instruction .....	33
2.2.24	Clock instruction .....	34
2.2.25	Motion instruction .....	34
<b>3</b>	<b>Instruction Description .....</b>	<b>37</b>
3.1	Basic instruction .....	37
3.1.1	Non processing instruction (NOP) .....	37

3.1.2	Contact instruction(LOAD) .....	38
3.1.3	Contact instruction(LOADN).....	39
3.1.4	Contact instruction(LOADP).....	40
3.1.5	Contact instruction(LOADF).....	41
3.1.6	Contact instruction(AND) .....	42
3.1.7	Contact instruction(ANDN).....	43
3.1.8	Contact instruction(ANDP) .....	44
3.1.9	Contact instruction(ANDF) .....	45
3.1.10	Contact instruction(ANDL) .....	46
3.1.11	Contact instruction(OR).....	47
3.1.12	Contact instruction(ORN) .....	48
3.1.13	Contact instruction(ORP) .....	49
3.1.14	Contact instruction(ORF) .....	50
3.1.15	Contact instruction(ORL).....	51
3.1.16	Output instruction(OUT).....	52
3.1.17	Output instruction(OUT Syyy.xx).....	53
3.1.18	Output instruction(OUTP).....	54
3.1.19	Output instruction(OUTF).....	55
3.1.20	Output instruction(SET).....	56
3.1.21	Output instruction(SET Syyy.xx) .....	57
3.1.22	Output instruction(RST) .....	58
3.1.23	Reversal instruction(ALT).....	59
3.1.24	Reversal instruction(NOT).....	60
3.1.25	Stack instruction(MPUSH).....	61
3.1.26	Stack instruction(MLOAD).....	62
3.1.27	Stack instruction(MPOP) .....	63
3.1.28	Exit instruction(END).....	64
3.2	Application instruction.....	65
3.2.1	Counter instruction(CTU) .....	65
3.2.2	Counter instruction(CTD) .....	66
3.2.3	Counter instruction(CTUD).....	67
3.2.4	Counter instruction(CTR) .....	68
3.2.5	Timer instruction(TON).....	69
3.2.6	Timer instruction(TOFF) .....	70
3.2.7	Timer instruction(TMR).....	71
3.2.8	Timer instruction(TMON).....	72
3.2.9	Timer instruction(TRTG).....	73
3.2.10	Control instruction(JMP).....	74
3.2.11	Control instruction(LABEL).....	75
3.2.12	Control instruction(FCALL).....	76
3.2.13	Control instruction(FUNC).....	77
3.2.14	Branch instruction(CALL) .....	78
3.2.15	Branch instruction(SUBRT).....	79
3.2.16	Branch instruction(RET).....	80
3.2.17	Loop instruction(FOR).....	81
3.2.18	Loop instruction(NEXT).....	82
3.2.19	Loop instruction(BREAK) .....	83
3.2.20	Master control instruction(MCS).....	84
3.2.21	Master control instruction(MCR) .....	85
3.2.22	Interrupt instruction(EI).....	86
3.2.23	Interrupt instruction(DI) .....	87
3.2.24	Interrupt instruction(ETI) .....	88

3.2.25	Interrupt instruction(EEI)	89
3.2.26	Interrupt instruction(DTI)	90
3.2.27	Interrupt instruction(DEI)	91
3.2.28	Interrupt instruction(TINT)	92
3.2.29	Interrupt instruction(EINT)	93
3.2.30	Interrupt instruction(IRET)	94
3.2.31	Watchdog timer(WDT)	95
3.2.32	Input comparison instruction(LOAD=)	96
3.2.33	Input comparison instruction(LOAD>)	97
3.2.34	Input comparison instruction(LOAD<)	98
3.2.35	Input comparison instruction(LOAD<>)	99
3.2.36	Input comparison instruction(LOAD>=)	100
3.2.37	Input comparison instruction(LOAD<=)	101
3.2.38	Input comparison instruction(DLOAD=)	102
3.2.39	Input comparison instruction(DLOAD>)	103
3.2.40	Input comparison instruction(DLOAD<)	104
3.2.41	Input comparison instruction(DLOAD<>)	105
3.2.42	Input comparison instruction(DLOAD>=)	106
3.2.43	Input comparison instruction(DLOAD<=)	107
3.2.44	Input comparison instruction(AND=)	108
3.2.45	Input comparison instruction(AND>)	109
3.2.46	Input comparison instruction(AND<)	110
3.2.47	Input comparison instruction(AND<>)	111
3.2.48	Input comparison instruction(AND>=)	112
3.2.49	Input comparison instruction(AND<=)	113
3.2.50	Input comparison instruction(DAND=)	114
3.2.51	Input comparison instruction(DAND>)	115
3.2.52	Input comparison instruction(DAND<)	116
3.2.53	Input comparison instruction(DAND<>)	117
3.2.54	Input comparison instruction(DAND>=)	118
3.2.55	Input comparison instruction(DAND<=)	119
3.2.56	Input comparison instruction(OR=)	120
3.2.57	Input comparison instruction(OR>)	121
3.2.58	Input comparison instruction(OR<)	122
3.2.59	Input comparison instruction(OR<>)	123
3.2.60	Input comparison instruction(OR>=)	124
3.2.61	Input comparison instruction(OR<=)	125
3.2.62	Input comparison instruction(DOR=)	126
3.2.63	Input comparison instruction(DOR>)	127
3.2.64	Input comparison instruction(DOR<)	128
3.2.65	Input comparison instruction(DOR<>)	129
3.2.66	Input comparison instruction(DOR>=)	130
3.2.67	Input comparison instruction(DOR<=)	131
3.2.68	Comparison instruction(CMP)	132
3.2.69	Comparison instruction(DCMP)	133
3.2.70	Comparison instruction(ACMP)	134
3.2.71	Comparison instruction(CMPL)	135
3.2.72	Comparison instruction(DCMPL)	136
3.2.73	Comparison instruction(BWCMP)	137
3.2.74	Comparison instruction(DBWCMP)	139
3.2.75	Transmission instruction(BMOV)	141
3.2.76	Transmission instruction(MOV)	142



3.2.77	Transmission instruction(DMOV)	143
3.2.78	Transmission instruction(BMOVL)	144
3.2.79	Transmission instruction(MOVL)	145
3.2.80	Transmission instruction(DMOVL)	146
3.2.81	Transmission instruction(BMOVG)	147
3.2.82	Transmission instruction(MOVG)	148
3.2.83	Transmission instruction(DMOVG)	149
3.2.84	Transmission instruction(BCMOV)	150
3.2.85	Transmission instruction(CMOV)	151
3.2.86	Transmission instruction(DCMOV)	152
3.2.87	Exchange instruction(XCH)	153
3.2.88	Exchange instruction(DXCH)	154
3.2.89	Exchange instruction(AXCH)	155
3.2.90	Exchange instruction(SWAP)	156
3.2.91	Exchange instruction(DSWAP)	157
3.2.92	Rotation instruction(ROR)	158
3.2.93	Rotation instruction(DROR)	159
3.2.94	Rotation instruction(AROR)	160
3.2.95	Rotation instruction(RORC)	161
3.2.96	Rotation instruction(DRORC)	162
3.2.97	Rotation instruction(ARORC)	163
3.2.98	Rotation instruction(ROL)	164
3.2.99	Rotation instruction(DROL)	165
3.2.100	Rotation instruction(AROL)	166
3.2.101	Rotation instruction(ROLC)	167
3.2.102	Rotation instruction(DROLC)	168
3.2.103	Rotation instruction(AROLC)	169
3.2.104	Movement instruction(SFTR)	170
3.2.105	Movement instruction(ASFTR)	171
3.2.106	Movement instruction(SFTL)	172
3.2.107	Movement instruction(ASFTL)	173
3.2.108	Movement instruction(WSFTR)	174
3.2.109	Movement instruction(WSFTL)	175
3.2.110	Arithmetic operation instruction(ADD)	176
3.2.111	Arithmetic operation instruction(DADD)	177
3.2.112	Arithmetic operation instruction(ADDU)	178
3.2.113	Arithmetic operation instruction(DADDU)	179
3.2.114	Arithmetic operation instruction(ADDL)	180
3.2.115	Arithmetic operation instruction(DADDL)	181
3.2.116	Arithmetic operation instruction(ADDLU)	182
3.2.117	Arithmetic operation instruction(DADDLU)	183
3.2.118	Arithmetic operation instruction(SUB)	184
3.2.119	Arithmetic operation instruction(DSUB)	185
3.2.120	Arithmetic operation instruction(SUBU)	186
3.2.121	Arithmetic operation instruction(DSUBU)	187
3.2.122	Arithmetic operation instruction(SUBL)	188
3.2.123	Arithmetic operation instruction(DSUBL)	189
3.2.124	Arithmetic operation instruction(SUBLU)	190
3.2.125	Arithmetic operation instruction(DSUBLU)	191
3.2.126	Arithmetic operation instruction(MUL)	192
3.2.127	Arithmetic operation instruction(DMUL)	193
3.2.128	Arithmetic operation instruction(MULU)	194

3.2.129 Arithmetic operation instruction(DMULU).....	195
3.2.130 Arithmetic operation instruction(MULL).....	196
3.2.131 Arithmetic operation instruction(DMULL).....	197
3.2.132 Arithmetic operation instruction(MULLU).....	198
3.2.133 Arithmetic operation instruction(DMULLU).....	199
3.2.134 Arithmetic operation instruction(DIV).....	200
3.2.135 Arithmetic operation instruction(DDIV).....	201
3.2.136 Arithmetic operation instruction(DIVU).....	202
3.2.137 Arithmetic operation instruction(DDIVU).....	203
3.2.138 Arithmetic operation instruction(DIVL).....	204
3.2.139 Arithmetic operation instruction(DDIVL).....	205
3.2.140 Arithmetic operation instruction(DIVLU).....	206
3.2.141 Arithmetic operation instruction(DDIVLU).....	207
3.2.142 Arithmetic operation instruction(INC).....	208
3.2.143 Arithmetic operation instruction(DINC).....	209
3.2.144 Arithmetic operation instruction(DEC).....	210
3.2.145 Arithmetic operation instruction(DDEC).....	211
3.2.146 Arithmetic operation instruction(ADDB).....	212
3.2.147 Arithmetic operation instruction(DADDB).....	213
3.2.148 Arithmetic operation instruction(ADDBL).....	214
3.2.149 Arithmetic operation instruction(DADDBL).....	215
3.2.150 Arithmetic operation instruction(SUBB).....	216
3.2.151 Arithmetic operation instruction(DSUBB).....	217
3.2.152 Arithmetic operation instruction(SUBBL).....	218
3.2.153 Arithmetic operation instruction(DSUBBL).....	219
3.2.154 Arithmetic operation instruction(MULB).....	220
3.2.155 Arithmetic operation instruction(DMULB).....	221
3.2.156 Arithmetic operation instruction(MULBL).....	222
3.2.157 Arithmetic operation instruction(DMULBL).....	223
3.2.158 Arithmetic operation instruction(DIVB).....	224
3.2.159 Arithmetic operation instruction(DDIVB).....	225
3.2.160 Arithmetic operation instruction(DIVBL).....	226
3.2.161 Arithmetic operation instruction(DDIVBL).....	227
3.2.162 Arithmetic operation instruction(INCB).....	228
3.2.163 Arithmetic operation instruction(DINCB).....	229
3.2.164 Arithmetic operation instruction(DEC).....	230
3.2.165 Arithmetic operation instruction(DDEC).....	231
3.2.166 Logical operation instruction(WAND).....	232
3.2.167 Logical operation instruction(DAND).....	233
3.2.168 Logical operation instruction(AAND).....	234
3.2.169 Logical operation instruction(WANDL).....	235
3.2.170 Logical operation instruction(DANDL).....	236
3.2.171 Logical operation instruction(WOR).....	237
3.2.172 Logical operation instruction(DOR).....	238
3.2.173 Logical operation instruction(AOR).....	239
3.2.174 Logical operation instruction(WORL).....	240
3.2.175 Logical operation instruction(DORL).....	241
3.2.176 Logical operation instruction(XOR).....	242
3.2.177 Logical operation instruction(DXOR).....	243
3.2.178 Logical operation instruction(AXOR).....	244
3.2.179 Logical operation instruction(XORL).....	245
3.2.180 Logical operation instruction(DXORL).....	246

3.2.181 Logical operation instruction(XNR) .....	247
3.2.182 Logical operation instruction(DXNR).....	248
3.2.183 Logical operation instruction(AXNR).....	249
3.2.184 Logical operation instruction(XNRL).....	250
3.2.185 Logical operation instruction(DXNRL).....	251
3.2.186 BIN/BCD conversion instruction(BIN2BCD).....	252
3.2.187 BIN/BCD conversion instruction(DBIN2BCD).....	253
3.2.188 BIN/BCD conversion instruction(BCD2BIN).....	254
3.2.189 BIN/BCD conversion instruction(DBCD2BIN).....	255
3.2.190 String conversion instruction(BIN2HASC).....	256
3.2.191 String conversion instruction(DBIN2HASC).....	257
3.2.192 String conversion instruction(HASC2BIN).....	258
3.2.193 String conversion instruction(DHASC2BIN).....	259
3.2.194 String conversion instruction(BCD2DASC).....	260
3.2.195 String conversion instruction(DBCD2DASC).....	261
3.2.196 String conversion instruction(DASC2BIN).....	262
3.2.197 String conversion instruction(DDASC2BIN).....	263
3.2.198 String conversion instruction(STR2ASC).....	264
3.2.199 String conversion instruction(DASC2BCD).....	265
3.2.200 String conversion instruction(DDASC2BCD).....	266
3.2.201 String conversion instruction(BIN2DASC).....	267
3.2.202 String conversion instruction(DBIN2DASC).....	268
3.2.203 Code conversion instruction(GRY2BIN).....	269
3.2.204 Code conversion instruction(DGRY2BIN).....	270
3.2.205 Code conversion instruction(BIN2GRY).....	271
3.2.206 Code conversion instruction(DBIN2GRY).....	272
3.2.207 Sign reversal instruction(NEG).....	273
3.2.208 Sign reversal instruction(DNEG).....	274
3.2.209 Data conversion instruction(DECO).....	275
3.2.210 Data conversion instruction(ENCO).....	276
3.2.211 Data conversion instruction(EXT).....	277
3.2.212 Refresh instruction(REF).....	278
3.2.213 Display instruction(SEG).....	279
3.2.214 Clock instruction(TCMP).....	281
3.2.215 Clock instruction(TADD).....	282
3.2.216 Clock instruction(TSUB).....	283
3.2.217 Clock instruction(TRD).....	284
3.2.218 Clock instruction(TWR).....	285
3.2.219 Clock instruction(HOUR).....	286
3.2.220 Clock instruction(TZCP).....	287
3.2.221 Motion instruction(MTVDM).....	289
3.2.222 Motion instruction(MTPDM).....	289
3.2.223 Motion instruction(MTIDM).....	291
3.2.224 Motion instruction(MTMEC).....	292
3.2.225 Motion instruction(MTEMS).....	293
3.2.226 Motion instruction(MTCPP).....	294
3.2.227 Motion instruction(MTFOS).....	295
3.2.228 Motion instruction(MTSRS).....	296
3.2.229 Motion instruction(MTOBC).....	297
3.2.230 Motion instruction(MTOVV).....	299
3.2.231 Motion instruction(MTOVP).....	300
3.2.232 Motion instruction(MTIPT).....	301

3.2.233 Motion instruction(MTUIA)..... 302

# 1 Structures of instruction name

The structure of instruction name is divided into three parts and each part represents data type, instruction name, and data processing method respectively. The data type is usually located in front of instruction name, and the data processing method is located after the instruction name (Limited to a few of them).

## 1.1 Structure by data type

### (1) By data size

- 1) Bit data type instruction  
It has an instruction structure of Bxxxx after Bit's B.  
Ex) **BMOV**, **BMOVL**, **BMOVG** .... etc.
- 2) Nibble data type instruction (4bit)  
It has an instruction structure of Nxxxx after Nibble's N.
- 3) Half word data type instruction (8bit)  
It has an instruction structure of Hxxxx after Half Word's H.
- 4) Word data type instruction (1word)  
It has an instruction structure of xxxx without Word name.  
Ex) **MOV**, **MOVL**, **MOVG** .... etc.
- 5) Double word data instruction (2word)  
It has an instruction structure of Dxxx after Double word's D.  
Ex) **DMOV**, **DMOVL**, **DMOVB** .... etc.
- 6) User-defined data type instruction  
It has an instruction structure of Axxxx, after Any bit's A.  
Ex) **AOR**, **AAND**, **AXOR**, .... etc.

### (2) By data sign

There are signed and unsigned data types, and the former is typically used with omitting its name. On the other hand, the latter is used with "U" and "U" is positioned in the far last part of the instruction name.

If there is name according to data processing, in case of (xxxL, xxxG) it is placed to the back. For further details, refer to '1.2 Structure by data processing'.

- If there is no data processing method part: **MULU**, **ADDU**, **SUBU**, ..... etc.
- If there is a data processing method part: **MULLU**, **ADDLU**, **SUBLU** ..... etc.

### (3) By BCD data

BCD data has an instruction structure of xxxB after BCD's B.

Be sure that the data processing method part (List, Group) is always positioned after the BCD part.

- If there is no data processing method name. (1 : 1 process): **ADDB**, **MULB**, **SUBB**, ..... etc.
- If the data processing method name is 'List': **ADDBL**, **MULBL**, **SUBBL**, .... etc.

## 1.2 Structure by data processing

### (1) 1:1 processing instruction

It has an instruction structure of xxx with omitting the name.

Ex) MOV, ...

### (2) 1:N processing instruction

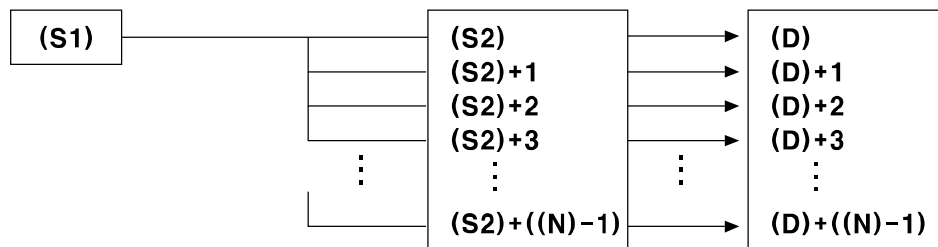
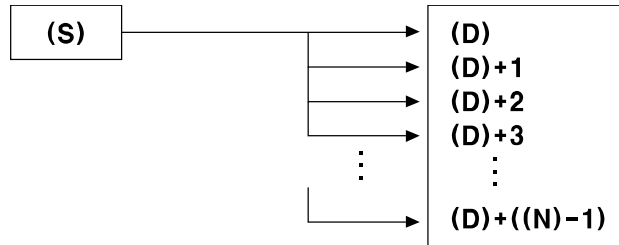

It has an instruction structure of xxxL after List's "L".

Ex) MOVL, ....

### (3) N:N processing instruction

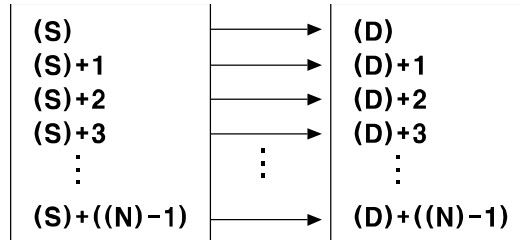

It has an instruction structure of xxxG after Group's "G".

Ex) MOVG, ...



### Note

Operand

- S: Represents source device
- D: Represents destination device
- N: Represents the number of devices







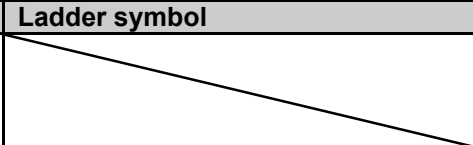



## 2 Instruction



### 2.1 Basic instruction list

#### 2.1.1 Non processing instruction

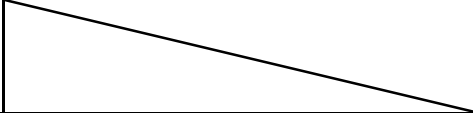



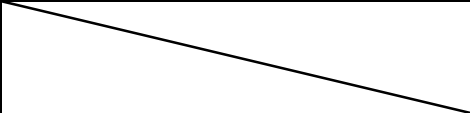

Instruction	Ladder symbol	Step	Page
NOP		1	37

#### 2.1.2 Contact instruction

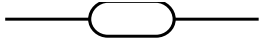

Instruction	Ladder symbol	Step	Page
LOAD		1	38
LOADN		1	39
LOADP		2	40
LOADF		2	41
AND		1	42
ANDN		1	43
ANDP		2	44
ANDF		2	45
ANDL		1	46
OR		1	47
ORN		1	48

Instruction	Ladder symbol	Step	Page
ORP		2	49
ORF		2	50
ORL		1	51

### 2.1.3 Output instruction

Instruction	Ladder symbol	Step	Page
OUT		1	52
OUT Syyy.xx		1	53
OUTP		2	54
OUTF		2	55
SET		1	56
SET Syyy.xx		1	57
RST		1	58

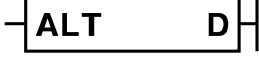
### 2.1.4 Reversal instruction

Instruction	Ladder symbol	Step	Page
ALT		3	59
NOT		1	60



### 2.1.5 Stack instruction



Instruction	Ladder symbol	Step	Page
MPUSH		1	61
MLOAD		1	62
MPOP		1	63

### 2.1.6 Exit instruction



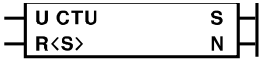
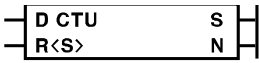

Instruction	Ladder symbol	Step	Page
END		1	64

## 2.2 Application instruction



### 2.2.1 Counter instruction

Instruction	Ladder symbol	Step	Page
CTU		5	65
CTD		5	66
CTUD		5	67
CTR		5	68

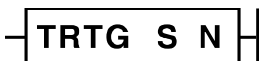
### 2.2.2 Timer instruction



Instruction	Ladder symbol	Step	Page
TON		5	69
TOFF		5	70
TMR		5	71
TMON		5	72
TRTG		5	73

### 2.2.3 Control instruction



Instruction	Ladder symbol	Step	Page
JMP		3	74
LABEL		3	75
FCALL		3	76

Instruction	Ladder symbol	Step	Page
FUNC		3	77

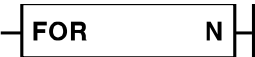

#### 2.2.4 Branch instruction

Instruction	Ladder symbol	Step	Page
CALL		3	78
SUBRT		3	79
RET		1	80



#### 2.2.5 Loop instruction





Instruction	Ladder symbol	Step	Page
FOR		3	81
NEXT		1	82
BREAK		1	83

#### 2.2.6 Master control instruction

Instruction	Ladder symbol	Step	Page
MCS		2	84
MCR		2	85

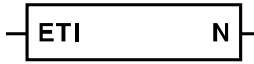
#### 2.2.7 Interrupt instruction

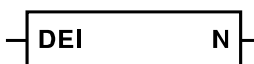
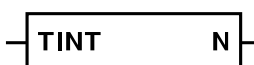
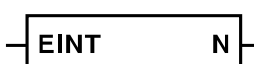



Instruction	Ladder symbol	Step	Page
EI		1	86
DI		1	87





Instruction	Ladder symbol	Step	Page
ETI		1	88
EEI		1	89
DTI		1	90
DEI		1	91
TINT		1	92
EINT		1	93
IRET		1	94

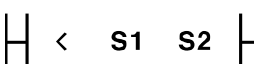
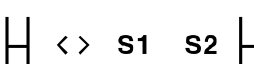



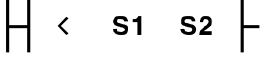
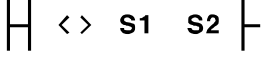
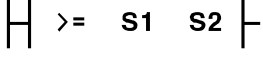
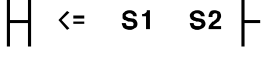
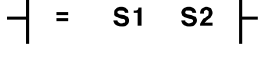
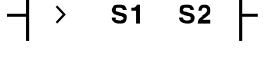
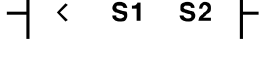
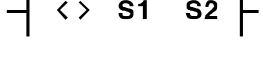
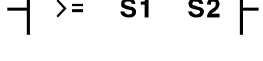
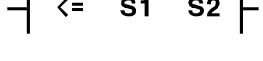

### 2.2.8 Watchdog timer

Instruction	Ladder symbol	Step	Page
WDT		1	95

### 2.2.9 Input comparison instruction

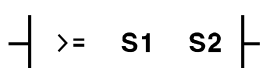
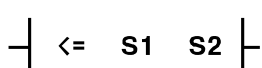
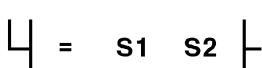

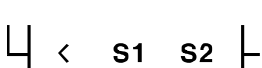
Instruction	Ladder symbol	Step	Page
LOAD=		5	96
LOAD>		5	97
LOAD<		5	98
LOAD<>		5	99
LOAD>=		5	100

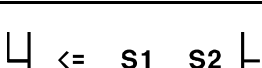
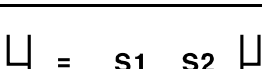
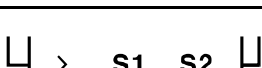
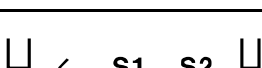
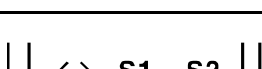
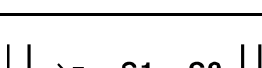
Instruction	Ladder symbol	Step	Page
LOAD<=		5	101
DLOAD=		5	102
DLOAD>		5	103
DLOAD<		5	104
DLOAD<>		5	105
DLOAD>=		5	106
DLOAD<=		5	107
AND=		5	108
AND>		5	109
AND<		5	110
AND<>		5	111
AND>=		5	112
AND<=		5	113
DAND=		5	114
DAND>		5	115

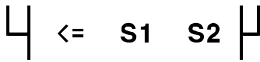
Instruction	Ladder symbol	Step	Page
DAND<		5	116
DAND<>		5	117
DAND>=		5	118
DAND<=		5	119
OR=		5	120
OR>		5	121
OR<		5	122
OR<>		5	123
OR>=		5	124
OR<=		5	125
DOR=		5	126
DOR>		5	127
DOR<		5	128
DOR<>		5	129
DOR>=		5	130

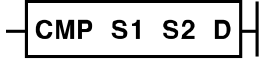

Instruction	Ladder symbol	Step	Page
DOR<=		5	131

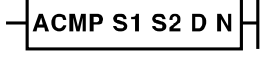
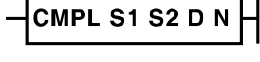
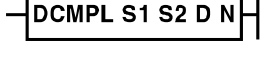
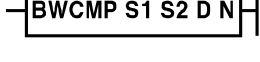
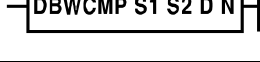
### 2.2.10 Comparison instruction



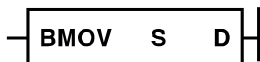
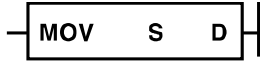
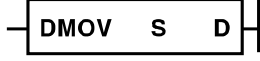
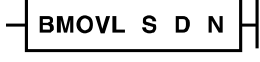
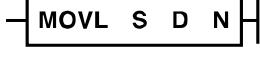

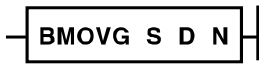
Instruction	Ladder symbol	Step	Page
CMP		7	132
DCMP		7	133
ACMP		7	134
CMPL		9	135
DCMPL		9	136
BWCMP		9	137
DBWCMP		9	139

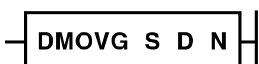
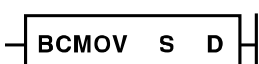
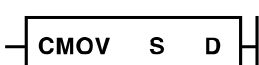
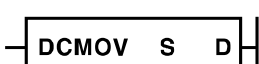
### 2.2.11 Transmission instruction

Instruction	Ladder symbol	Step	Page
BMOV		5	141
MOV		5	142
DMOV		5	143
BMOVL		7	144
MOVL		7	145

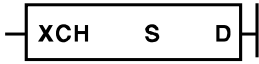

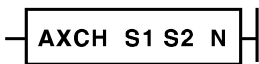
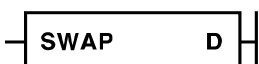



Instruction	Ladder symbol	Step	Page
DMOVL		7	146
BMOVG		7	147
MOVG		7	148
DMOVB		7	149
BCMOV		5	150
CMOV		5	151
DCMOV		5	152

### 2.2.12 Exchange instruction

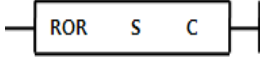

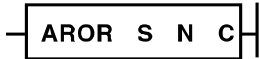
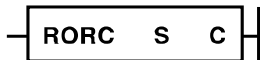
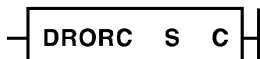
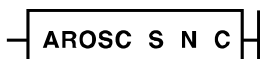
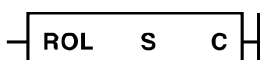
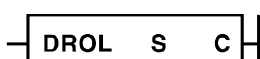

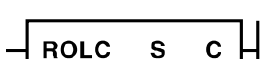

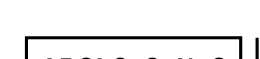
Instruction	Ladder symbol	Step	Page
XCH		5	153
DXCH		5	154
AXCH		7	155
SWAP		3	156
DSWAP		3	157



### 2.2.13 Rotation instruction

Instruction	Ladder symbol	Step	Page
ROR		5	158
DROR		5	159
AROR		7	160
RORC		5	161
DRORC		5	162
ARORC		7	163
ROL		5	164
DROL		5	165
AROL		7	166
ROLC		5	167
DROLC		5	168
AROLC		7	169

### 2.2.14 Movement instruction

Instruction	Ladder symbol	Step	Page
SFTR		9	170
ASFTR		9	171
SFTL		9	172
ASFTL		9	173
WSFTR		9	174
WSFTL		9	175

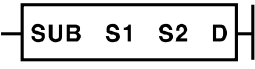
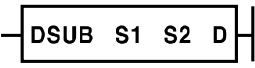
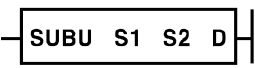
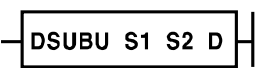
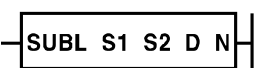
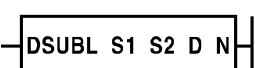
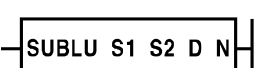
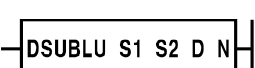
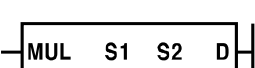
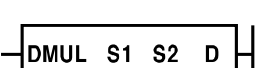
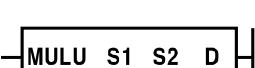
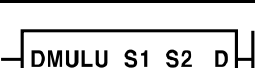
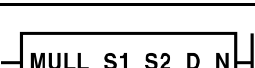
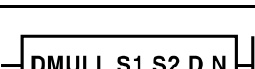
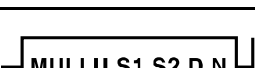

### 2.2.15 Arithmetic operation instruction

Instruction	Ladder symbol	Step	Page
ADD		7	176
DADD		7	177
ADDU		7	178
DADDU		7	179
ADDL		9	180
DADDL		9	181
ADDLU		9	182
DADDLU		9	183

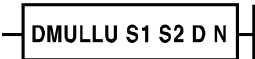
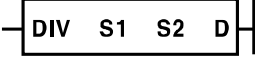
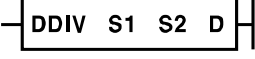
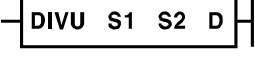
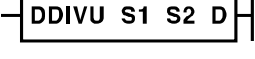
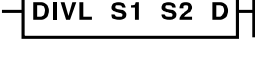
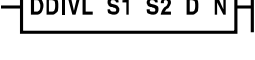
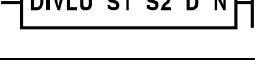
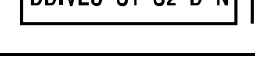
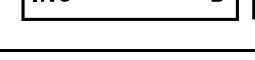
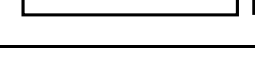
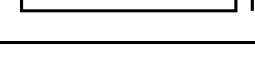
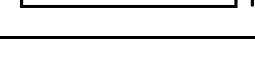
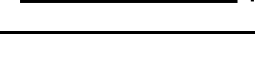
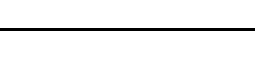
Instruction	Ladder symbol	Step	Page
SUB		7	184
DSUB		7	185
SUBU		7	186
DSUBU		7	187
SUBL		9	188
DSUBL		9	189
SUBLU		9	190
DSUBLU		9	191
MUL		7	192
DMUL		7	193
MULU		7	194
DMULU		7	195
MULL		9	196
DMULL		9	197
MULLU		9	198

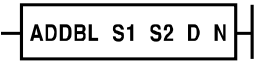
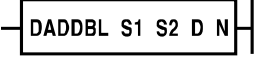
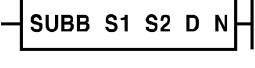
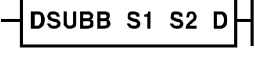
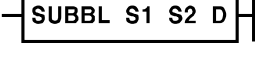
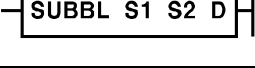
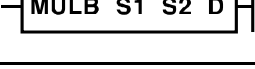
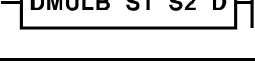
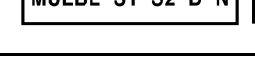
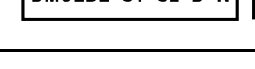
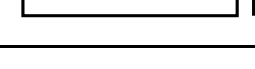
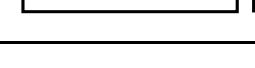
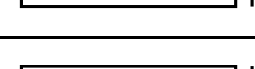
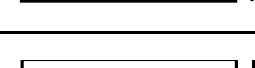
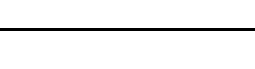
Instruction	Ladder symbol	Step	Page
DMULLU		9	199
DIV		7	200
DDIV		7	201
DIVU		7	202
DDIVU		7	203
DIVL		9	204
DDIVL		9	204
DIVLU		9	206
DDIVLU		9	207
INC		3	208
DINC		3	209
DEC		3	210
DDEC		3	211
ADDB		7	212
DADDB		7	213

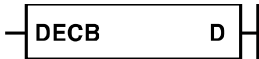
Instruction	Ladder symbol	Step	Page
ADDBL		9	214
DADDBL		9	215
SUBB		7	216
DSUBB		7	217
SUBBL		9	218
DSUBBL		9	219
MULB		7	220
DMULB		7	221
MULBL		9	222
DMULBL		9	223
DIVB		7	224
DDIVB		7	225
DIVBL		9	226
DDIVBL		9	227
INCB		3	228

Instruction	Ladder symbol	Step	Page
DINCB		3	229
DECB		3	230
DDECB		3	231

### 2.2.16 Logical operation instruction

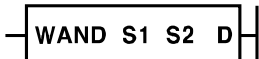
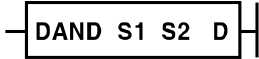
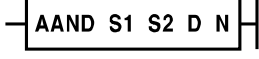
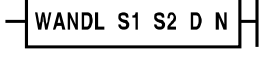
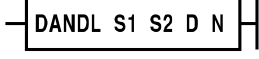
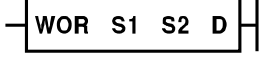
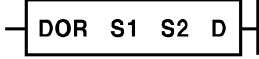
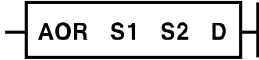
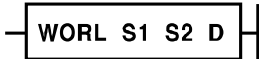
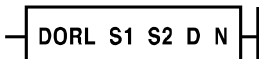
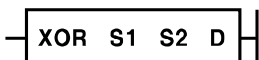

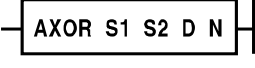
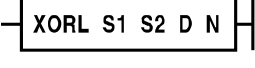
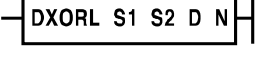
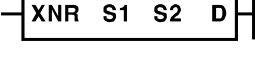
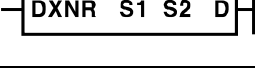
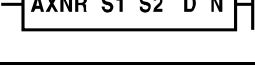
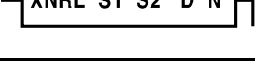
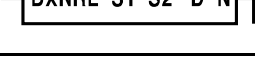



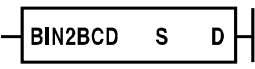
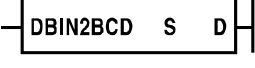
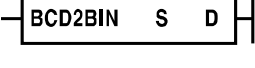
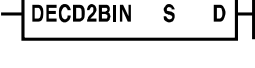



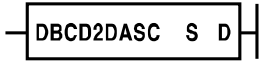

Instruction	Ladder symbol	Step	Page
WAND		7	232
DAND		7	233
AAND		9	234
WANDL		9	235
DANDL		9	236
WOR		7	237
DOR		7	238
AOR		9	239
WORL		9	240
DORL		9	241
XOR		7	242

Instruction	Ladder symbol	Step	Page
DXOR		7	243
AXOR		9	244
XORL		9	245
DXORL		9	246
XNR		7	247
DXNR		7	248
AXNR		9	249
XNRL		9	250
DXNRL		9	251

### 2.2.17 BIN/BCD instruction

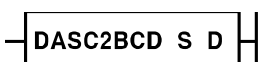

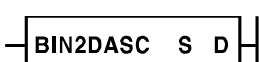

Instruction	Ladder symbol	Step	Page
BIN2BCD		5	252
DBIN2BCD		5	253
BCD2BIN		5	254
DBCD2BIN		5	255

### 2.2.18 String conversion instruction



Instruction	Ladder symbol	Step	Page
BIN2HASC		5	256
DBIN2HASC		5	257
HASC2BIN		5	258
DHASC2BIN		5	259
BCD2DASC		5	260
DBCD2DASC		5	261
DASC2BIN		5	262
DDASC2BIN		5	263
STR2ASC		7	264
DASC2BCD		5	265
DDASC2BCD		5	266
BIN2DASC		5	267
DBIN2DASC		5	268



**2.2.19 Code conversion instruction**

Instruction	Ladder symbol	Step	Page
GRY2BIN		5	269
DGRY2BIN		5	270
BIN2GRY		5	271
DBIN2GRY		5	272

**2.2.20 Sign reversal instruction**

Instruction	Ladder symbol	Step	Page
NEG		3	273
DNEG		3	274

**2.2.21 Data conversion instruction**

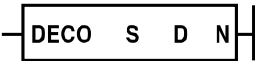
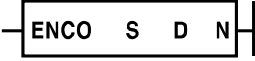
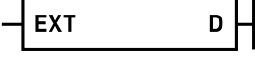
Instruction	Ladder symbol	Step	Page
DECO		7	275
ENCO		7	276
EXT		3	277

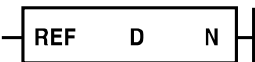

**2.2.22 Refresh instruction**

Instruction	Ladder symbol	Step	Page
REF		5	278

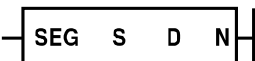

**2.2.23 Display instruction**

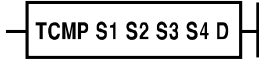
Instruction	Ladder symbol	Step	Page
SEG		7	279

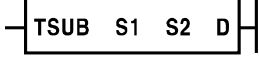
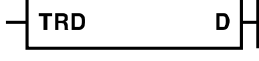
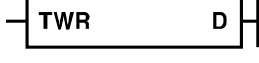
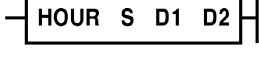
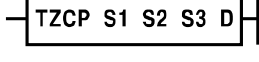
### 2.2.24 Clock instruction

Instruction	Ladder symbol	Step	Page
TCMP		7	281
TADD		7	282
TSUB		7	283
TRD		3	284
TWR		3	285
HOUR		7	286
TZCP		9	287

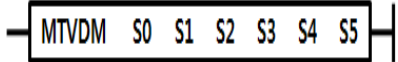
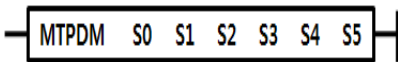
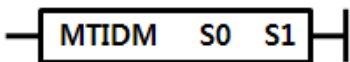
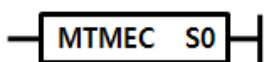
### 2.2.25 Motion instruction

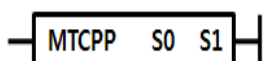
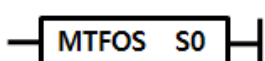
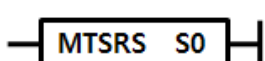
Instruction	Ladder symbol	Step	Page
MTVDM		9	289
MTPDM		9	289
MTIDM		5	290
MTMEC		5	292
MTEMS		5	293
MTCPP		5	294
MTFOS		5	295
MTSRS		5	296

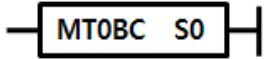
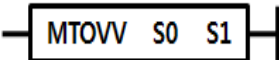
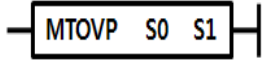
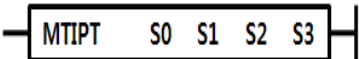
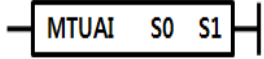
Instruction	Ladder symbol	Step	Page
MTOBC		5	297
MTOVV		5	299
MTOVP		5	300
MTIPT		7	301
MTUAI		5	302



## 3 Instruction Description

### 3.1 Basic instruction

#### 3.1.1 Non processing instruction (NOP)

Non processing instruction NOP	Applicable model
	LP-S044, LP-S070

1. It is non processing instruction.
2. It is available only for mnemonic program.

### 3.1.2 Contact instruction(LOAD)

<b>Contact instruction</b>		<b>LOAD</b>	<b>S</b>	Applicable model LP-S044, LP-S070					
OP	DATA type	Available device / Description / Range			Error	Zero	Carry	Borrow	Step
S	BIT	X, Y, M, S, T, C, F, UB			<input type="checkbox"/>	<input type="checkbox"/>	<input type="checkbox"/>	<input type="checkbox"/>	1
		Contact of bit device							
		Not applicable							

<Ladder>

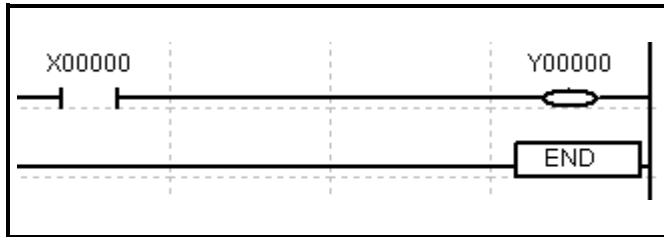

When the contact(S) is ON, the corresponding output bit becomes 1.

<Time chart>

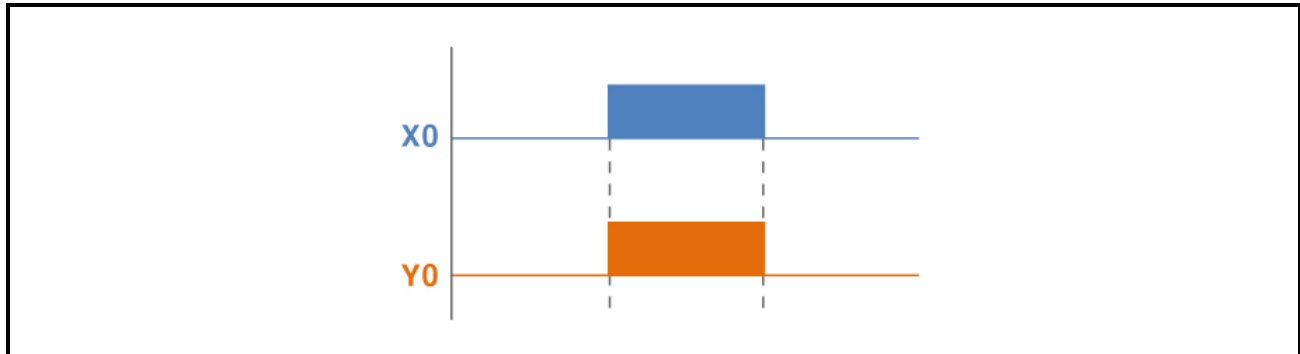

### 3.1.3 Contact instruction(LOADN)

<b>Contact instruction</b>		<b>LOADN</b>	<b>S</b>	Applicable model LP-S044, LP-S070					
OP	DATA type	Available device / Description / Range			Error	Zero	Carry	Borrow	Step
<b>S</b>	BIT	X, Y, M, S, T, C, F, UB							
		Contact of bit device							
		Not applicable							1

<Ladder>

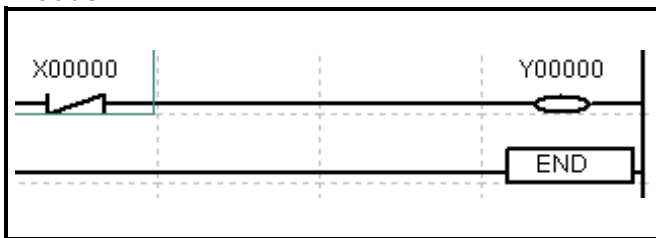

When the (S) bit turns OFF from ON, the operation result becomes ON from OFF.

<Time chart>

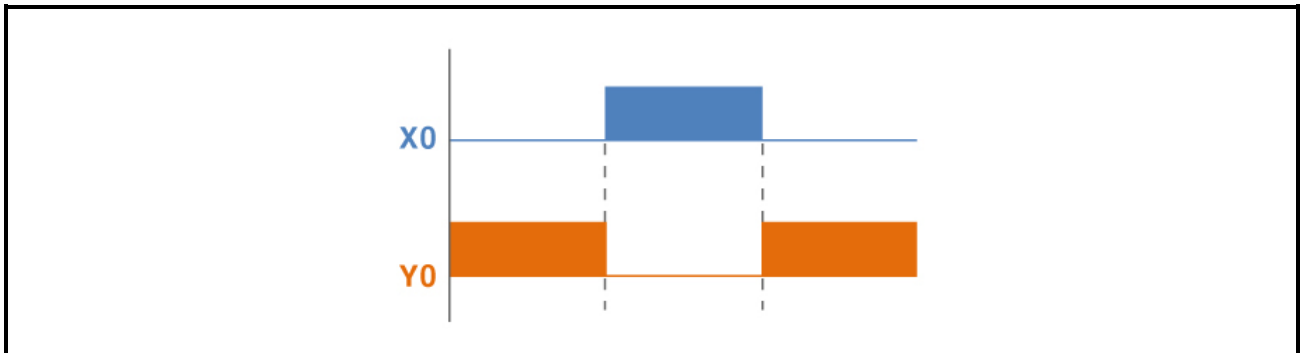

### 3.1.4 Contact instruction(LOADP)

<b>Contact instruction</b>		<b>LOADP</b>	<b>S</b>	Applicable model LP-S044, LP-S070					
OP	DATA type	Available device / Description / Range			Error	Zero	Carry	Borrow	Step
<b>S</b>	BIT	X, Y, M, S, T, C, F, UB							
		Contact of bit device							
		Not applicable							2

<Ladder>

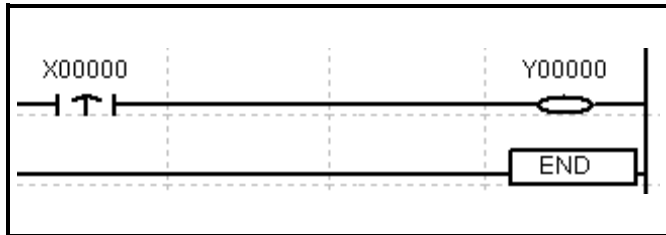

As soon as the (S) contact turns ON from OFF, the operation result becomes ON.

<Time chart>

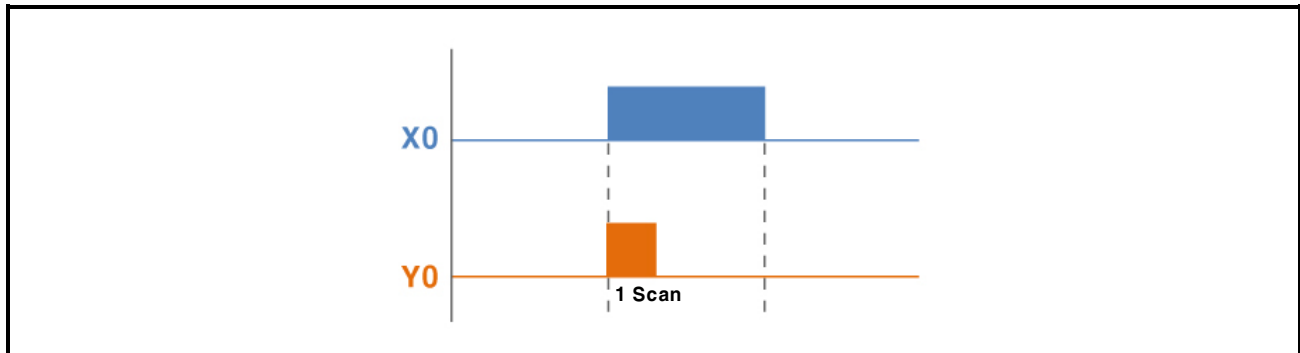



### 3.1.5 Contact instruction(LOADF)

<b>Contact instruction</b>		<b>LOADF</b>	<b>S</b>	Applicable model LP-S044, LP-S070					
OP	DATA type	Available device / Description / Range			Error	Zero	Carry	Borrow	Step
<b>S</b>	BIT	X, Y, M, S, T, C, F, UB							
		Contact of bit device							
		Not applicable							2

<Ladder>

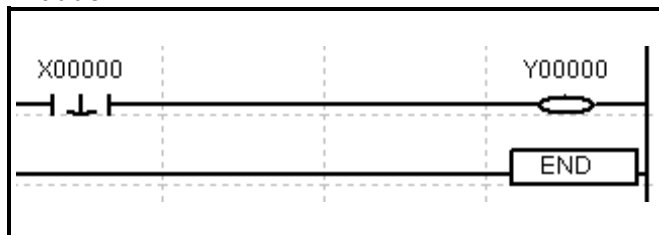

As soon as the (S) contact turns OFF from ON, the operation result becomes ON.

<Time chart>

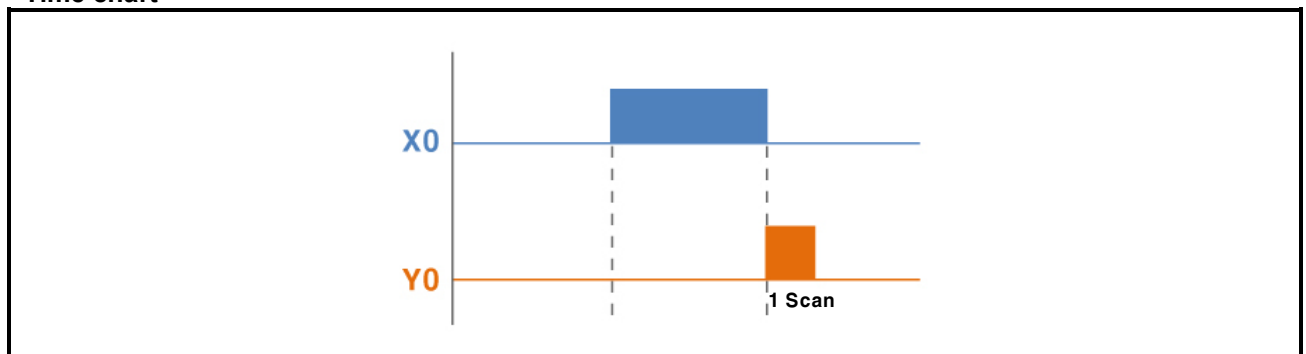

### 3.1.6 Contact instruction(AND)

<b>Contact instruction</b>		<b>AND</b>	<b>S</b>	Applicable model LP-S044, LP-S070					
OP	DATA type	Available device / Description / Range			Error	Zero	Carry	Borrow	Step
<b>S</b>	BIT	X, Y, M, S, T, C, F, UB							
		Contact of bit device							
		Not applicable							1

<Ladder>

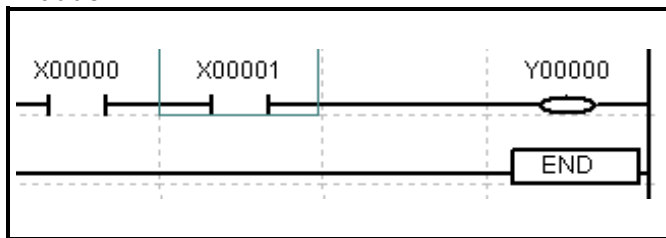

Executes AND operation between the previous operation result and the designated contact(S), and considers it as the operation result.

<Time chart>

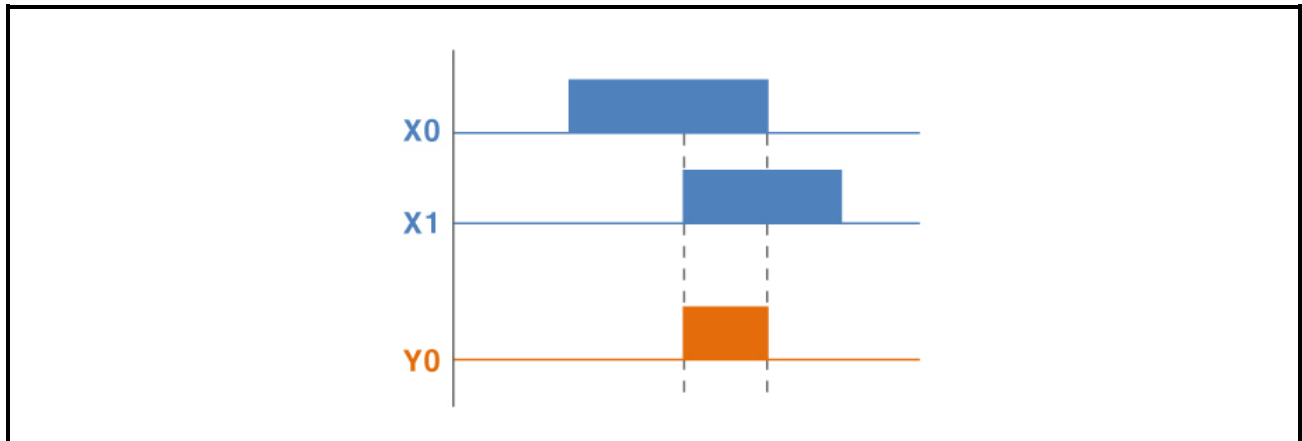

### 3.1.7 Contact instruction(ANDN)

<b>Contact instruction</b>		<b>ANDN</b>	<b>S</b>	Applicable model LP-S044, LP-S070					
OP	DATA type	Available device / Description / Range			Error	Zero	Carry	Borrow	Step
<b>S</b>	BIT	X, Y, M, S, T, C, F, UB							
		Contact of bit device							
		Not applicable							1

<Ladder>

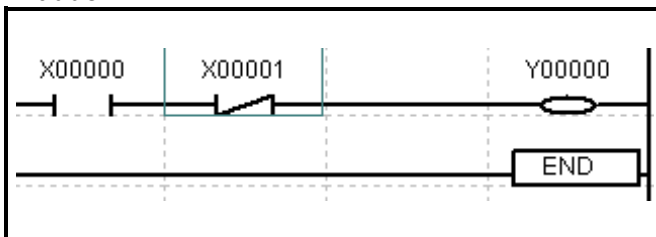

Executes AND NOT operation between the previous operation result and the designated contact(S), and considers it as the operation result.

<Time chart>

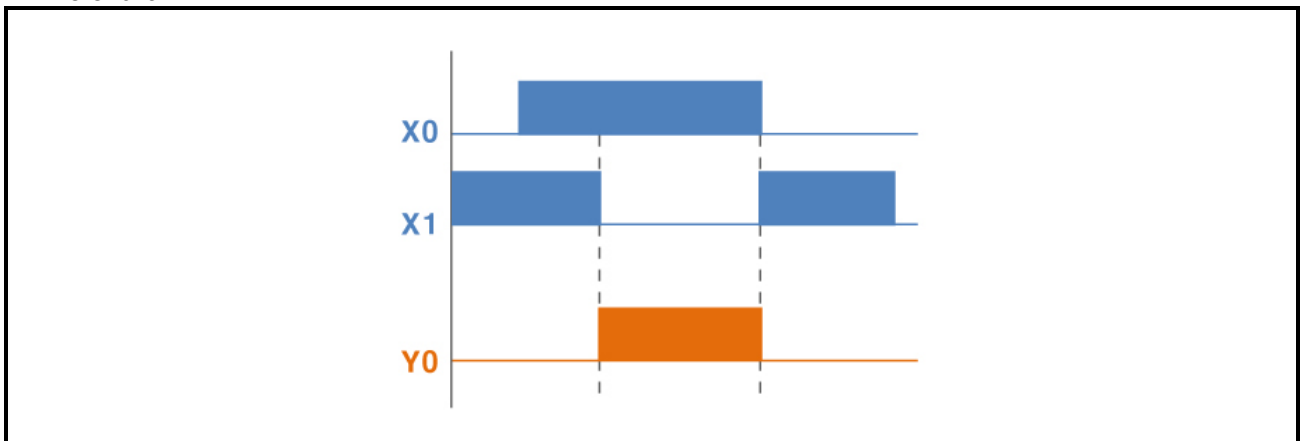

### 3.1.8 Contact instruction(ANDP)

<b>Contact instruction</b>		<b>ANDP</b>	<b>S</b>	Applicable model LP-S044, LP-S070					
OP	DATA type	Available device / Description / Range			Error	Zero	Carry	Borrow	Step
<b>S</b>	BIT	X, Y, M, S, T, C, F, UB							
		Contact of bit device							
		Not applicable							2

<Ladder>

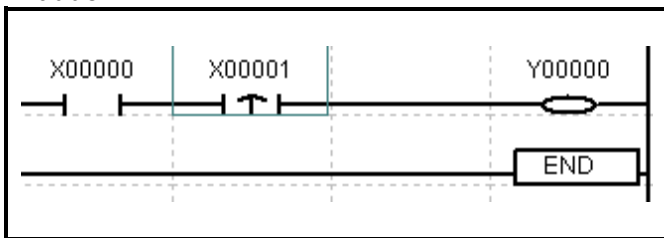

On the rising edge of a pulse, it executes AND operation between the previous operation result and the designated contact(S), and considers it as the operation result.

<Time chart>

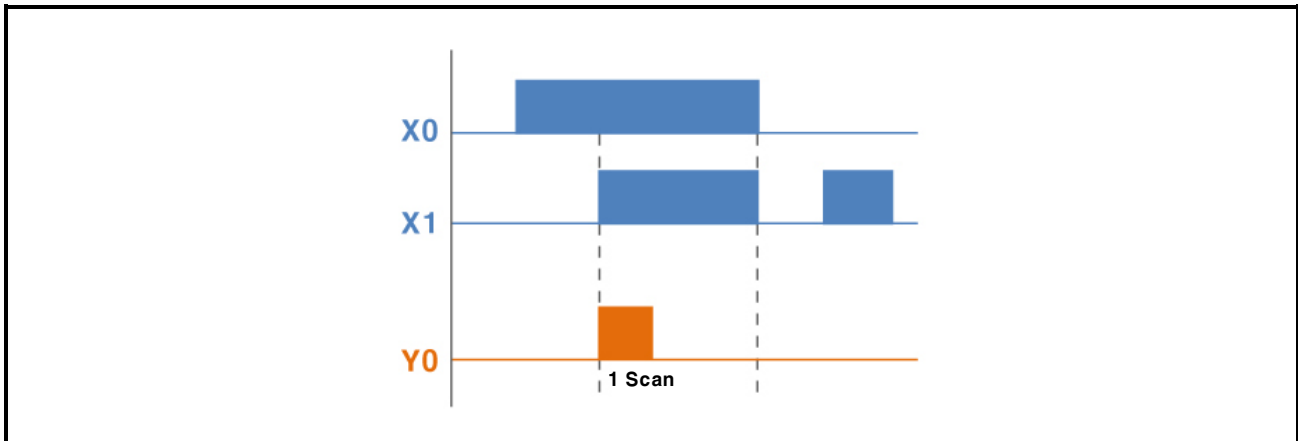

### 3.1.9 Contact instruction(ANDF)

<b>Contact instruction</b>		<b>ANDF</b>	<b>S</b>	Applicable model LP-S044, LP-S070					
OP	DATA type	Available device / Description / Range			Error	Zero	Carry	Borrow	Step
<b>S</b>	BIT	X, Y, M, S, T, C, F, UB							
		Contact of bit device							
		Not applicable							2

<Ladder>

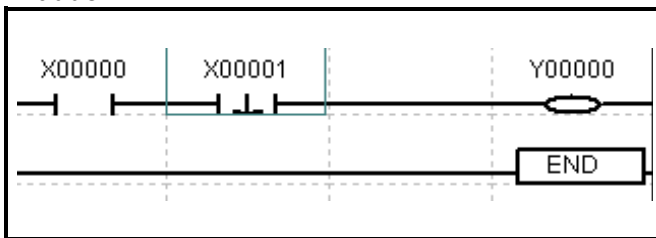

On the falling edge of a pulse, it executes AND operation between the previous operation result and the designated contact(S), and considers it as the operation result.

<Time chart>

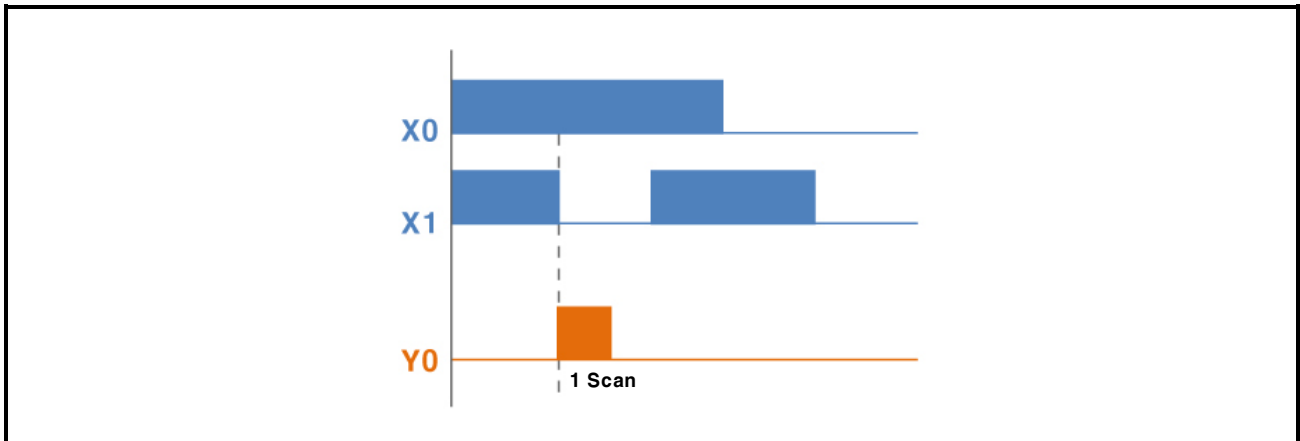

### 3.1.10 Contact instruction(ANDL)

Contact instruction ANDL

Applicable model  
LP-S044, LP-S070

#### <Mnemonic & Ladder>

Step	Instruction	OP1	OP2
0	LOAD	X00000	
1	LOAD	X00001	
2	OR	X00002	
3	ANDL		
4	OUT	Y00000	
5	END		

Executes the AND operation between the block and the block.

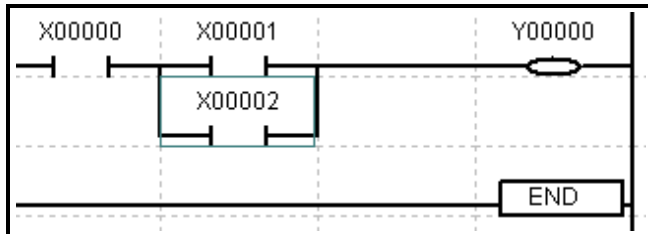

#### [Note]

- You cannot add as device input in ladder.
- Input for instruction is available only for mnemonic.

#### <Time chart>

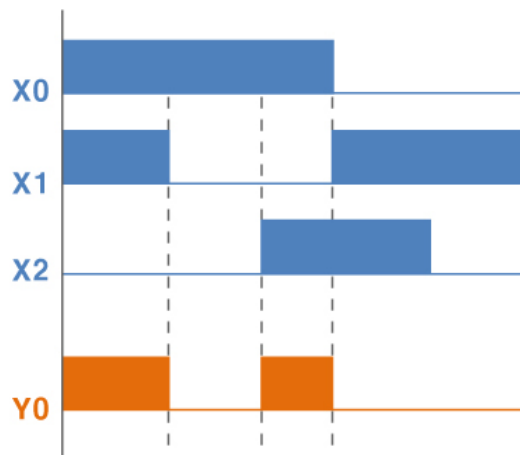

### 3.1.11 Contact instruction(OR)

<b>Contact instruction</b>		<b>OR</b>	<b>S</b>	Applicable model LP-S044, LP-S070					
OP	DATA type	Available device / Description / Range			Error	Zero	Carry	Borrow	Step
S	BIT	X, Y, M, S, T, C, F, UB							
		Contact of bit device							
		Not applicable							1

<Ladder>

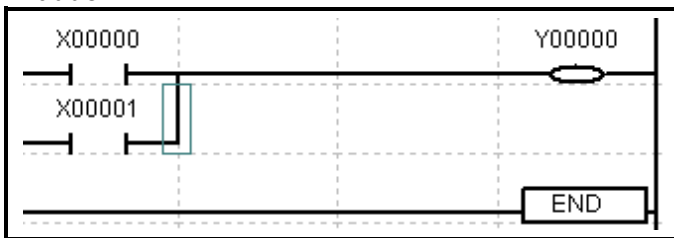

Executes the OR operation between the previous operation result and the designated contact(S), and considers it as the operation result.

<Time chart>

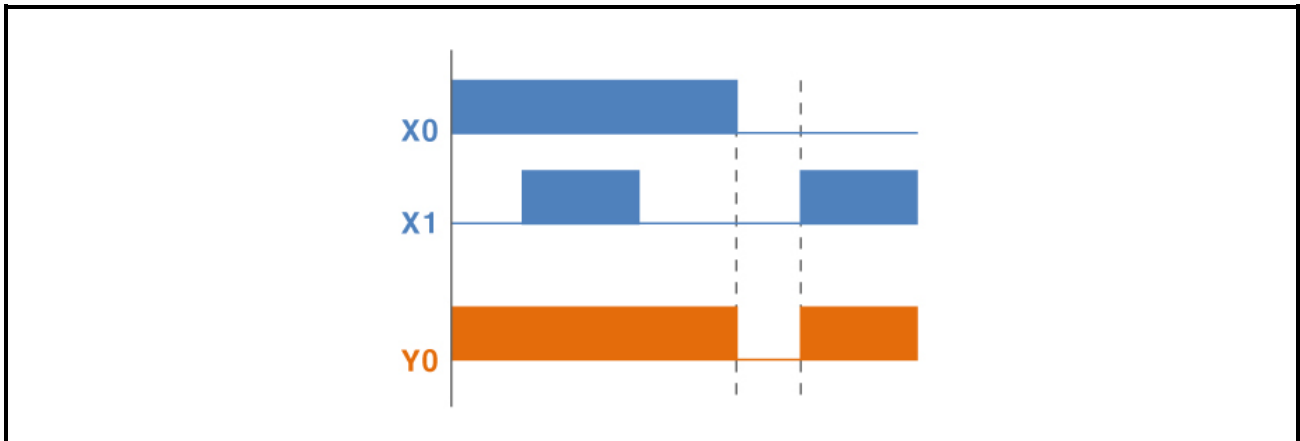

### 3.1.12 Contact instruction(ORN)

<b>Contact instruction</b>		<b>ORN</b>	<b>S</b>	Applicable model LP-S044, LP-S070					
OP	DATA type	Available device / Description / Range			Error	Zero	Carry	Borrow	Step
<b>S</b>	BIT	X, Y, M, S, T, C, F, UB							1
		Contact of bit device							
		Not applicable							

<Ladder>

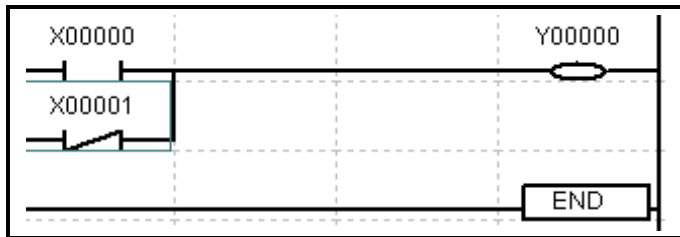

Executes the ORN operation between the previous operation result and the designated contact(S), and considers it as the operation result.

<Time chart>

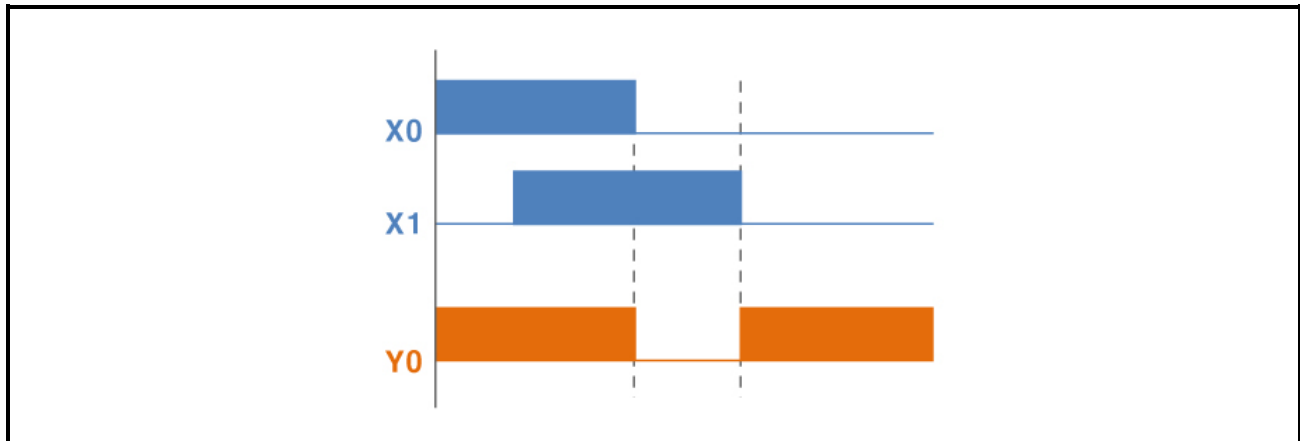



### 3.1.13 Contact instruction(ORP)

<b>Contact instruction</b>		<b>ORP</b>	<b>S</b>	Applicable model LP-S044, LP-S070					
OP	DATA type	Available device / Description / Range			Error	Zero	Carry	Borrow	Step
<b>S</b>	BIT	X, Y, M, S, T, C, F, UB							
		Contact of bit device							
		Not applicable							2

<Ladder>

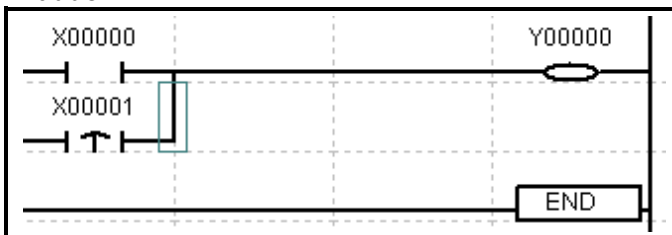

On the rising edge of a pulse, executes OR or ORN operation between the previous operation result and designated contact(S), and considers it as the operation result.

<Time chart>

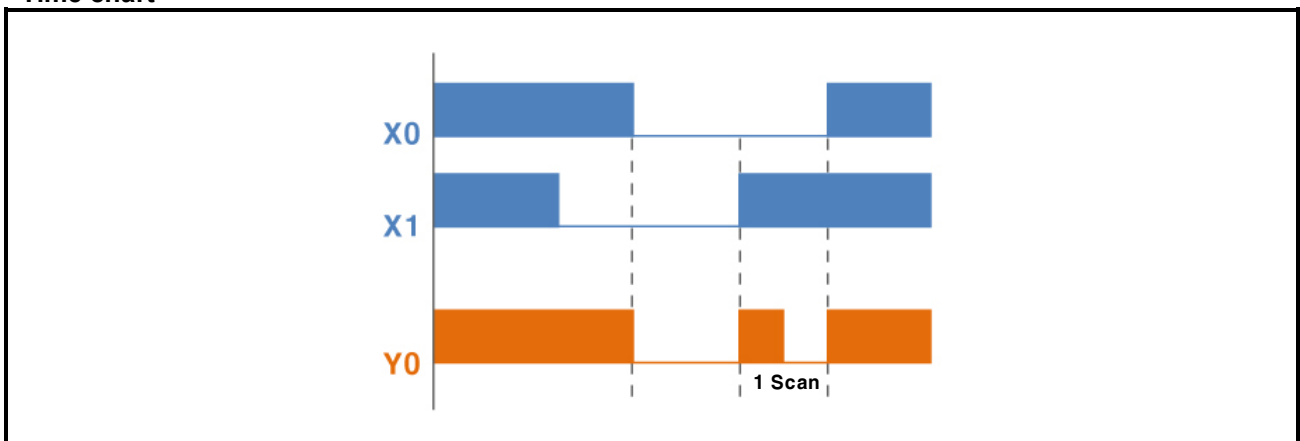

### 3.1.14 Contact instruction(ORF)

<b>Contact instruction</b>		<b>ORF</b>	<b>S</b>	Applicable model LP-S044, LP-S070					
OP	DATA type	Available device / Description / Range			Error	Zero	Carry	Borrow	Step
<b>S</b>	BIT	X, Y, M, S, T, C, F, UB							2
		Contact of bit device							
		Not applicable							

<Ladder>

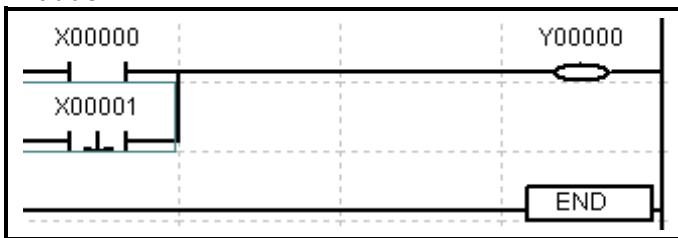

On the falling edge of a pulse, executes OR or ORN operation between the previous operation result and the designated contact(S), and considers it as the operation result.

<Time chart>

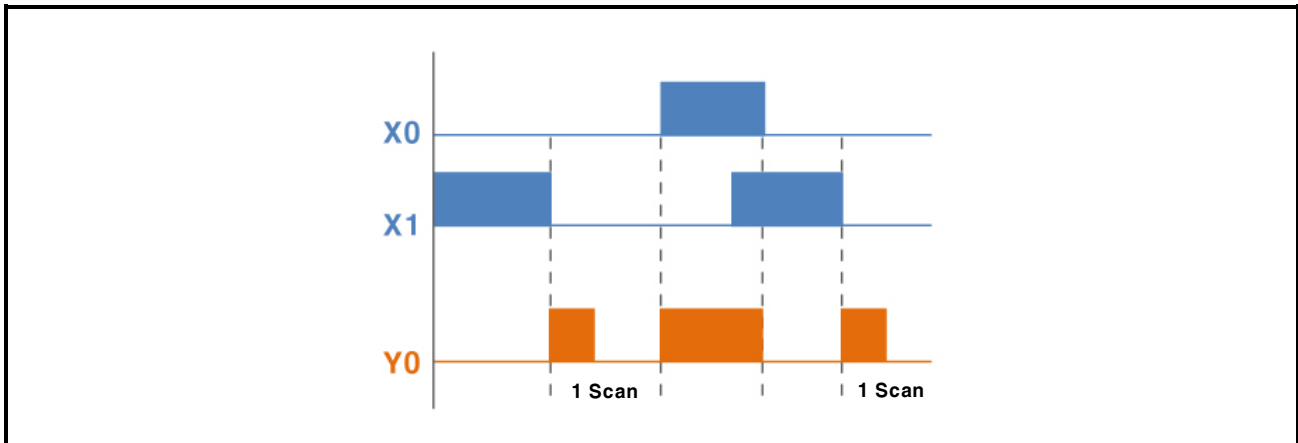

### 3.1.15 Contact instruction(ORL)

<p><b>Contact instruction</b>    <b>ORL</b></p>	<p>Applicable model LP-S044, LP-S070</p>
---	--

**<Mnemonic & Ladder>**

Step	Instruction	OP1	OP2
0	LOAD	X00000	
1	AND	X00001	
2	LOAD	X00002	
3	AND	X00003	
4	ORL		
5	OUT	Y00000	
6	END		

Executes the OR operation between the block and the block.

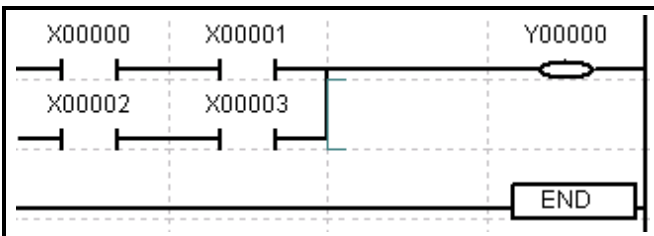

**[Note]**

- You cannot add as device input in ladder.
- Input for instruction is available only for mnemonic.

**<Time chart>**

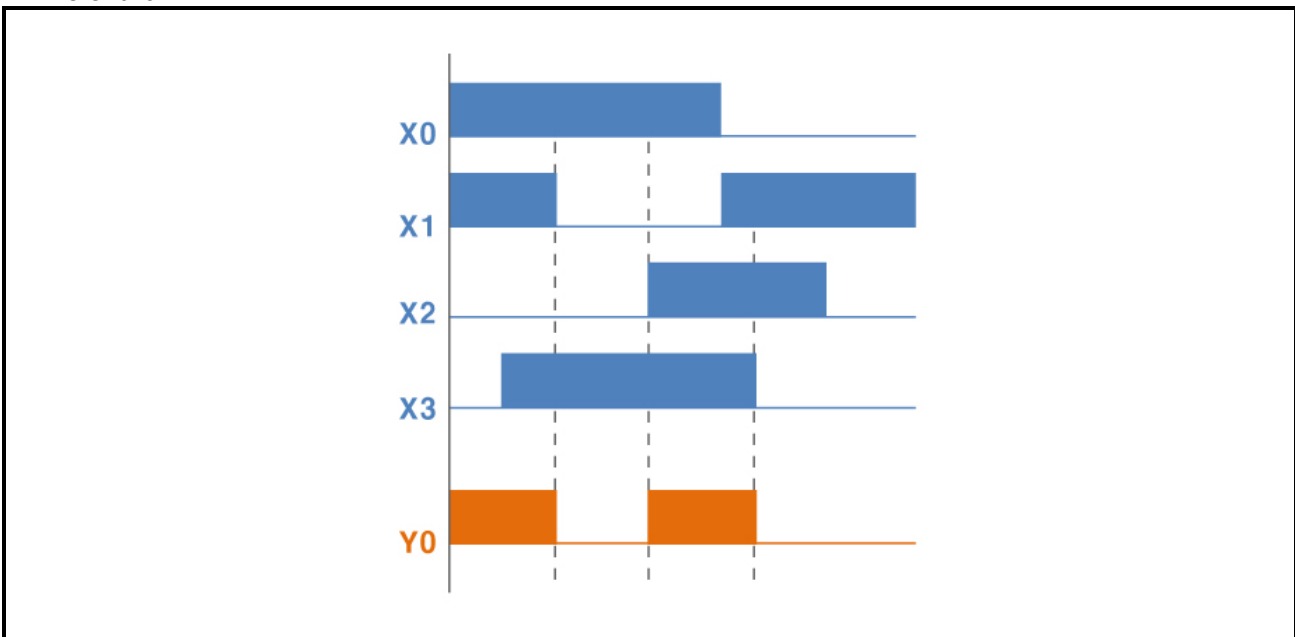

### 3.1.16 Output instruction(OUT)

<b>Output instruction</b>		<b>OUT</b>	<b>D</b>	Applicable model LP-S044, LP-S070					
OP	DATA type	Available device / Description / Range			Error	Zero	Carry	Borrow	Step
<b>D</b>	BIT	Y, F, S, M, UB							
		ON/OFF contact of device							
		Not applicable							1

<Ladder>

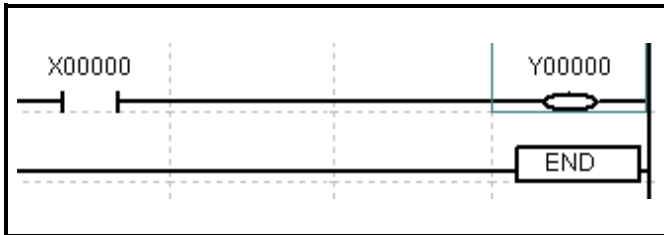

Outputs the operation result executed to the OUT instruction to the (S) device.

<Time chart>

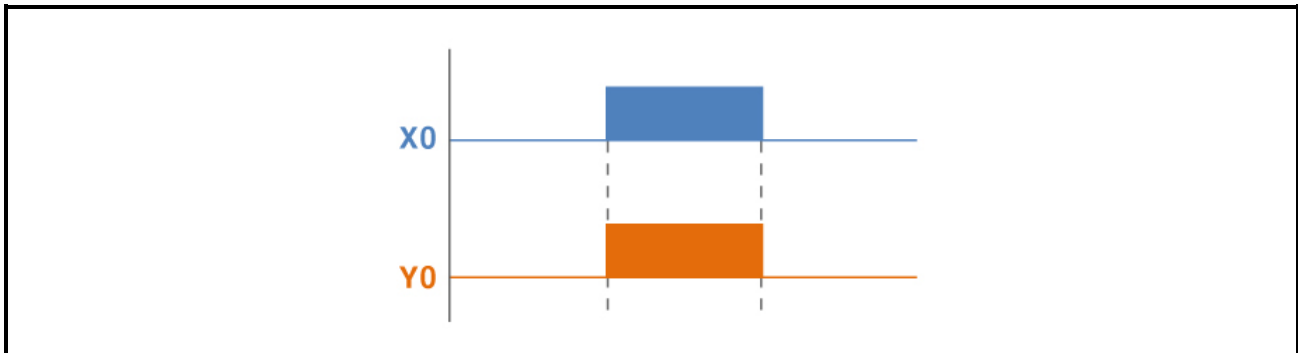

### 3.1.17 Output instruction(OUT Syyy.xx)

<b>Output instruction</b> <b>OUT Syyy.xx</b> <b>D</b>			Applicable model LP-S044, LP-S070				
OP	DATA type	Available device / Description / Range	Error	Zero	Carry	Borrow	Step
<b>D</b>	BIT	S					
		yyy is group number(0 to 255), xx is step number (0 to 99)					
		Not applicable					1

<Ladder>

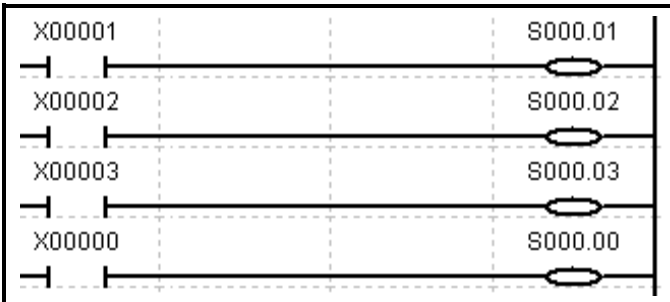

Step device

yyy: Group number(0 to 255)  
 xx: Step number(0 to 99)

1. Unlikely the Sequential Control(Set Syyy.xx) Instructions, if input condition turns ON, the corresponding step becomes ON regardless of the step order.
2. Although a number of input condition contacts become ON in the same group, the last programmed contact is output firstly.
3. Even if the input condition turns OFF, the step number retains ON.
4. In order to clear the OUT Syyy.xx instruction, the input contact of Syyy.00 should become ON.

<Time chart>

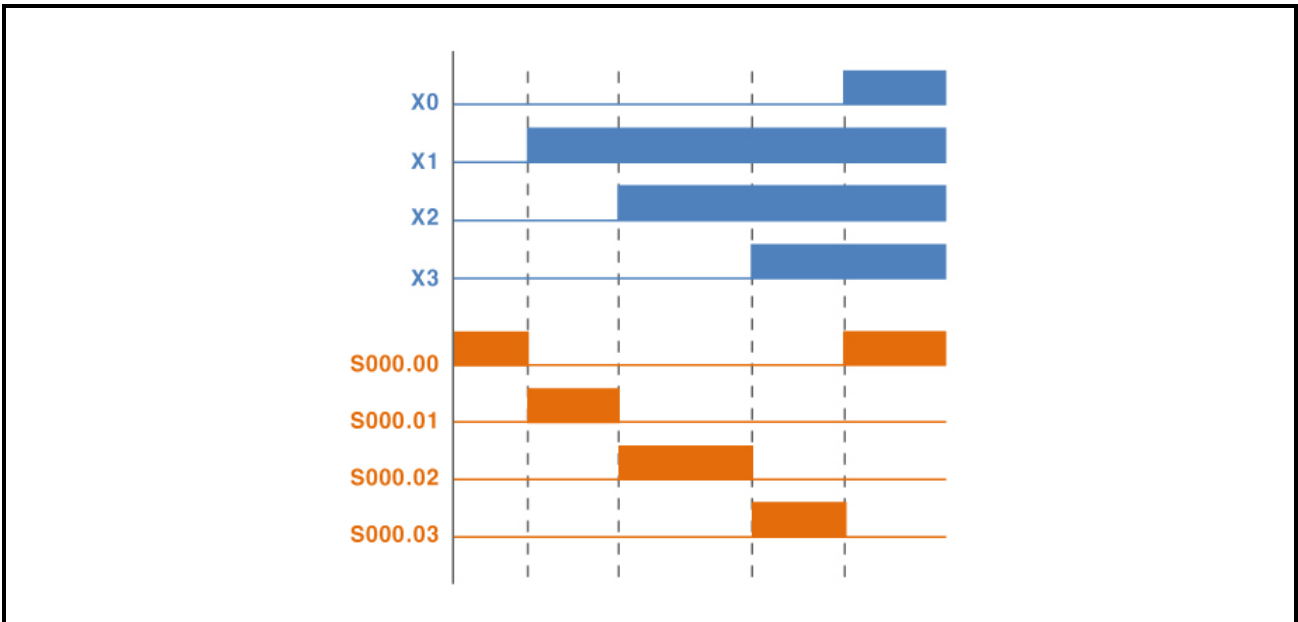

### 3.1.18 Output instruction(OUTP)

<b>Output instruction</b>		<b>OUTP</b>	<b>D</b>	Applicable model LP-S044, LP-S070					
OP	DATA type	Available device / Description / Range			Error	Zero	Carry	Borrow	Step
<b>D</b>	BIT	Y, F, S, M, UB							
		Contact to be ON for one scan on the rising edge of a pulse							
		Not applicable							2

<Ladder>

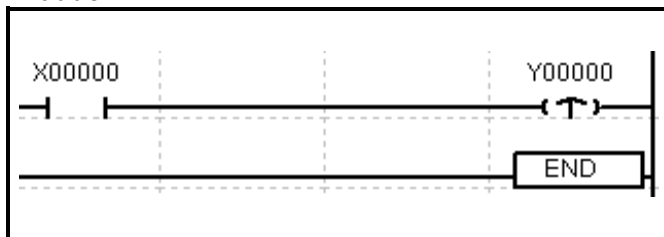

When the operation result executed to the OUTP turns OFF from ON, the output contact becomes ON for only one scan and then becomes OFF for any other cases.

<Time chart>

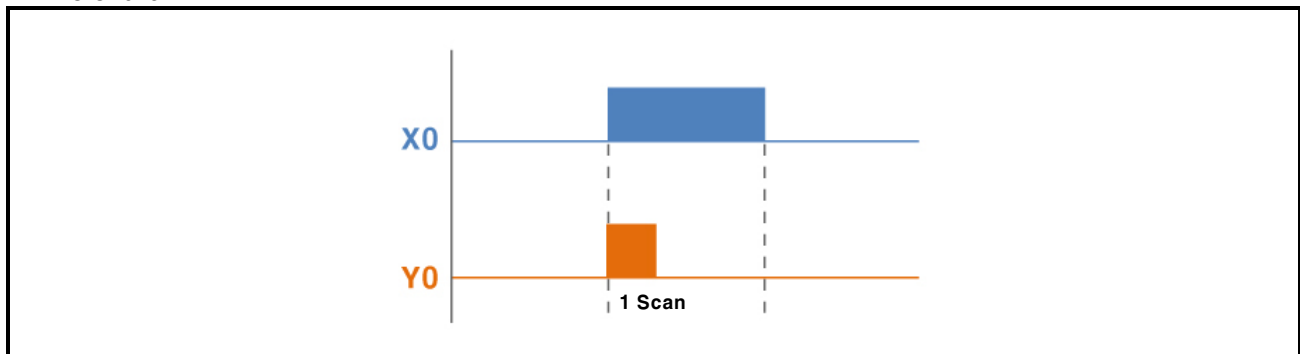

### 3.1.19 Output instruction(OUTF)

<b>Output instruction</b>		<b>OUTF</b>	<b>D</b>	Applicable model LP-S044, LP-S070					
OP	DATA type	Available device / Description / Range			Error	Zero	Carry	Borrow	Step
<b>D</b>	BIT	Y, F, S, M, UB							
		Contact to be ON for one scan on the falling edge of a pulse							
		Not applicable							2

<Ladder>

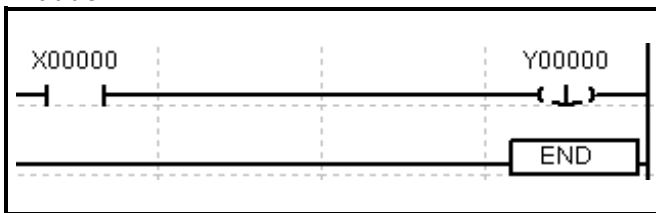

When the operation result executed to the OUTF turns OFF from ON, the output contact becomes ON for only one scan and then becomes OFF for any other cases.

<Time chart>

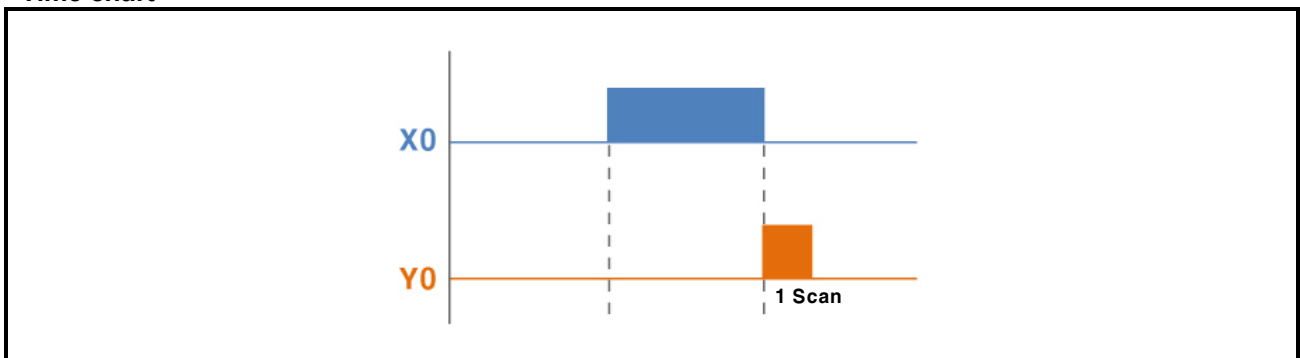

### 3.1.20 Output instruction(SET)

<b>Output instruction</b>		<b>SET</b>	<b>D</b>	Applicable model LP-S044, LP-S070					
OP	DATA type	Available device / Description / Range			Error	Zero	Carry	Borrow	Step
<b>D</b>	BIT	Y, F, S, T, C, M, UB							
		Contact to be maintained ON status							
		Not applicable							1

<Ladder>

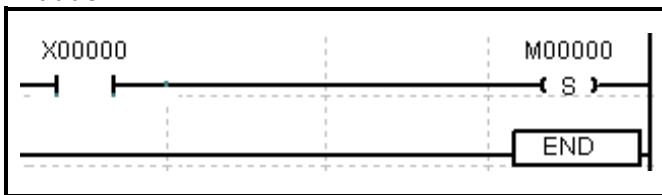

1. Once the contact is SET, even if the input condition turns OFF, it retains SET status.
2. In order to turn OFF the contact, you should execute the RST instruction.

<Time chart>

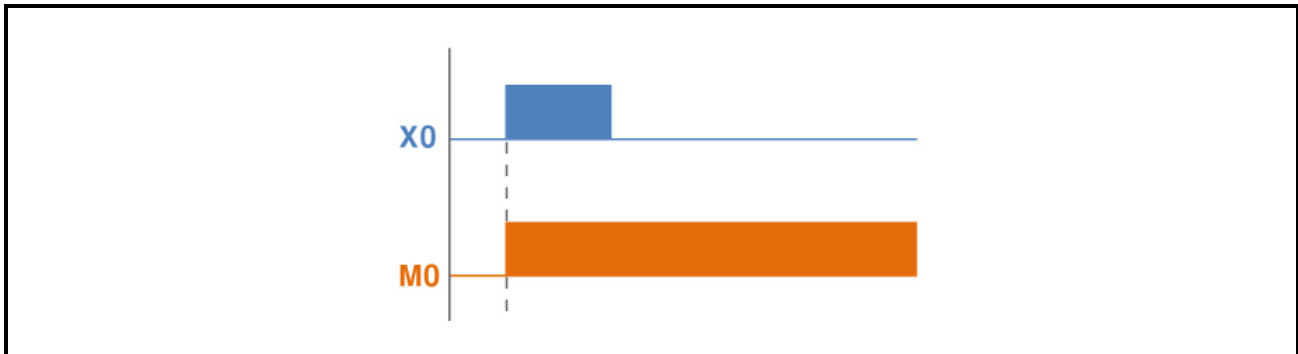



### 3.1.21 Output instruction(SET Syyy.xx)

<b>Output instruction</b> <b>SET Syyy.xx</b> <b>D</b>			Applicable model LP-S044, LP-S070				
OP	DATA type	Available device / Description / Range	Error	Zero	Carry	Borrow	Step
<b>D</b>	BIT	S					
		yyy is group number(0 to 255), xx is step number (0 to 99)					
		Not applicable					1

<Ladder>

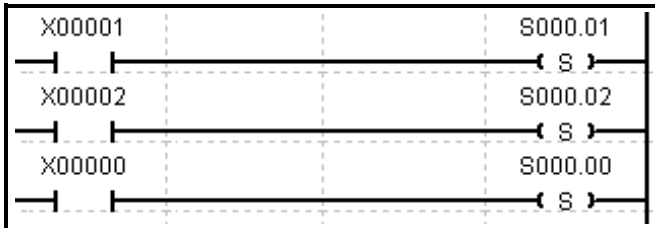

Step device

yyy: Group number(0 to 255)  
 xx: Step number(0 to 99)

1. If the input contact of current step number is ON while the previous step number is retaining ON status, the current step number turns ON and the previous step number turns OFF.
2. Even if the input contact turns OFF, S device at ON status still retains ON.
3. Syyy.00 is always ON status when starting the program.
4. In order to reset the Syyy.xx instruction, the input contact of Syyy.00 should become ON.

<Time chart>

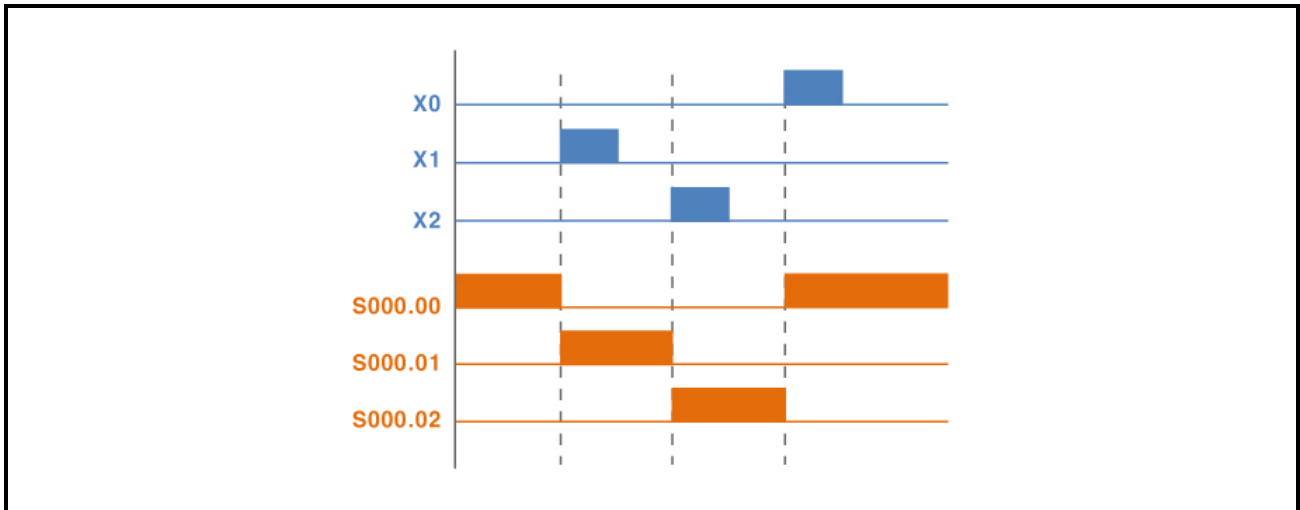

### 3.1.22 Output instruction(RST)

Output instruction		RST	D	Applicable model					
				LP-S044, LP-S070					
OP	DATA type	Available device / Description / Range			Error	Zero	Carry	Borrow	Step
D	BIT	Y, F, S, T, C, M, UB							
		Contact to be maintained OFF status							
		Not applicable							1

<Ladder>

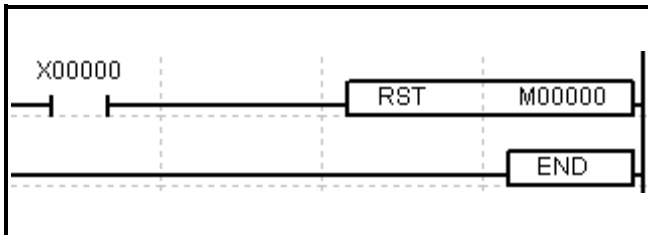

1. If the input condition turns ON, the corresponding contact becomes OFF.
2. Even if the input condition turns OFF, the corresponding contact still retains OFF.

<Time chart>

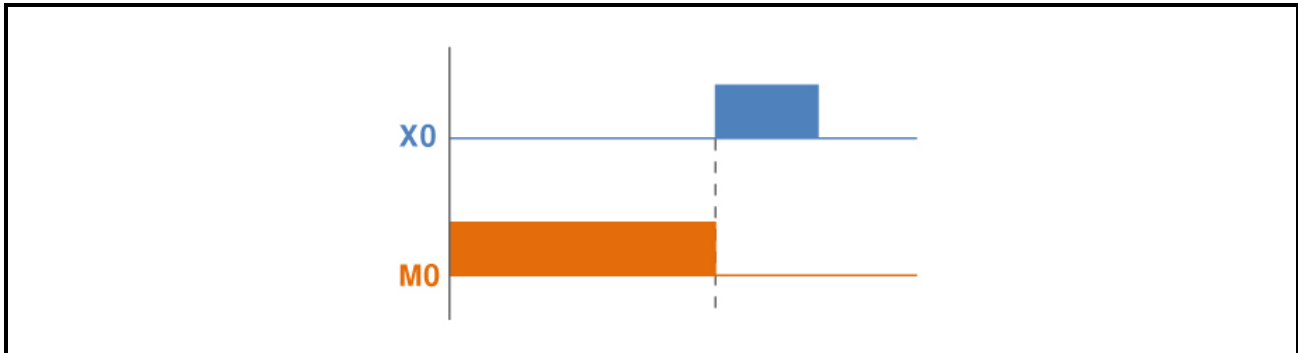

### 3.1.23 Reversal instruction(ALT)

<b>Reversal instruction</b>		<b>ALT</b>	<b>D</b>	Applicable model LP-S044, LP-S070					
OP	DATA type	Available device / Description / Range			Error	Zero	Carry	Borrow	Step
<b>D</b>	BIT	Y, F, M, UB							
		Data address to execute the operation							
		Not applicable							3

<Ladder>

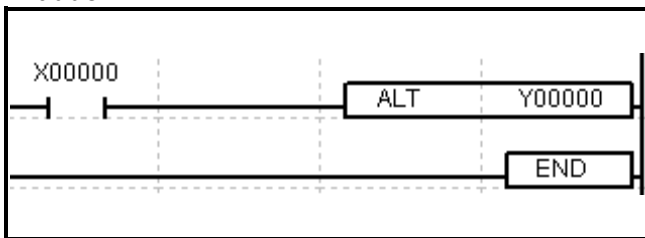

Whenever the input condition turns ON from OFF, the output is reversed according to this, and this event is consecutively executed every operation cycle.

<Time chart>

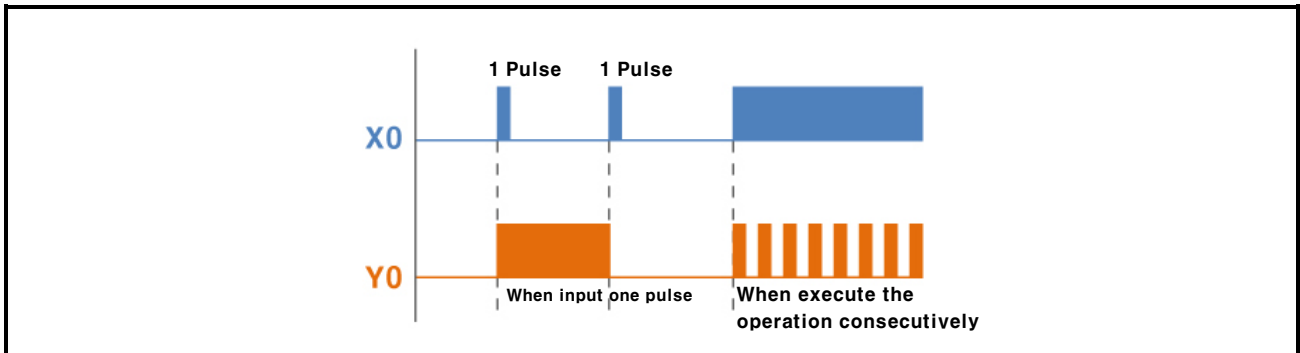

### 3.1.24 Reversal instruction(NOT)

Reversal instruction NOT

Applicable model  
LP-S044, LP-S070

<Ladder>

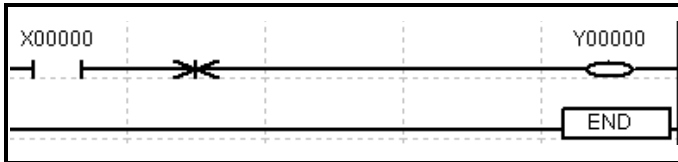

1. Transfers input by reversing.
2. A contact circuit is reversed as B contact circuit, B contact circuit is reversed as A contact circuit.

<Time chart>

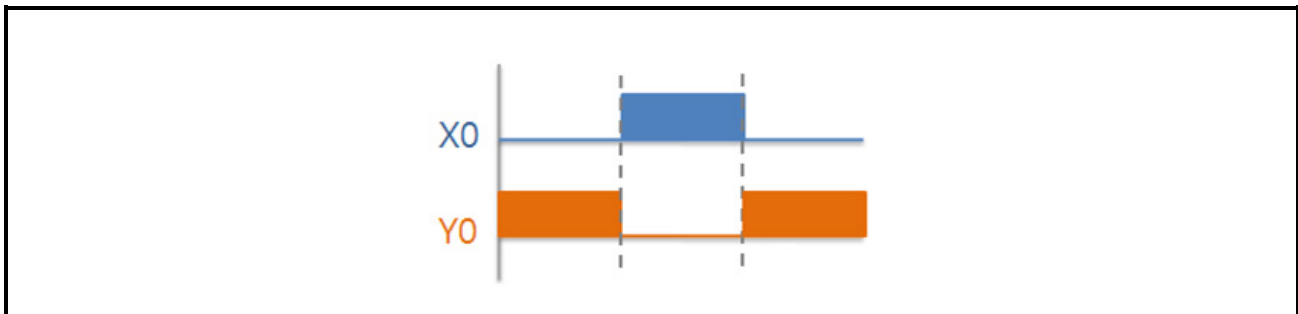

### 3.1.25 Stack instruction(MPUSH)

Stack  
instruction MPUSH

Applicable model  
LP-S044, LP-S070

The operation results executed to current are stored in the stack.

### 3.1.26 Stack instruction(MLOAD)

Stack  
instruction MLOAD

Applicable model  
LP-S044, LP-S070

Loads the value stored in the stack.

### 3.1.27 Stack instruction(MPOP)

Stack  
instruction MPOP

Applicable model  
LP-S044, LP-S070

Removes the data in the stack after reading it.

**3.1.28 Exit instruction(END)**

Exit  
instruction    **END**

Applicable model  
LP-S044, LP-S070

Exits the program.



### 3.2 Application instruction

#### 3.2.1 Counter instruction(CTU)

Counter instruction	CTU	S	N	Applicable model			
				LP-S044, LP-S070			
OP	DATA type	Available device / Description / Range					
S	WORD	C, UW	Error	Zero	Carry	Borrow	Step
		Counter contact you want to use					
		0(h0000) to 65535(hFFFF)					
N	WORD	X, Y, M, S, T, C, D, Z, F, UW, integer	Error	Zero	Carry	Borrow	Step
		Setting value of counter					
		0(h0000) to 65535(hFFFF)					

<Ladder>

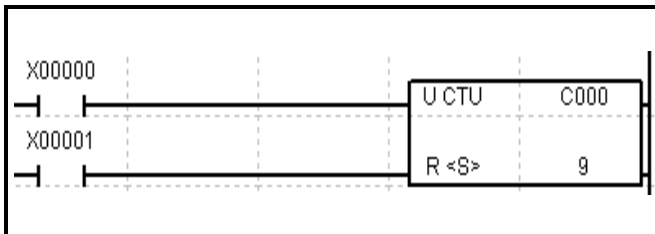

1. If the pulse signal is applied to the input rung when the reset signal is OFF, the word value of S device is increased one by one, and then when it reaches the setting value N, the corresponding counter contact turns ON.
2. If the reset signal turns ON, the word value of S device becomes 0.

<Time chart>

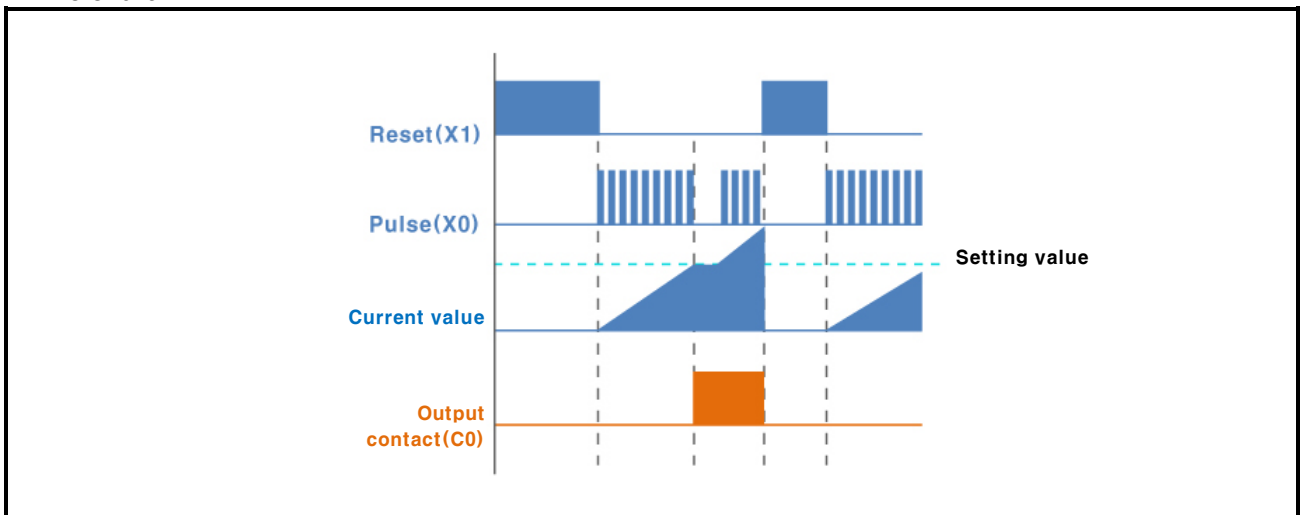

### 3.2.2 Counter instruction(CTD)

Counter instruction		CTD	S	N	Applicable model LP-S044, LP-S070				
OP	DATA type	Available device / Description / Range			Error	Zero	Carry	Borrow	Step
S	WORD	C, UW							5
		Counter contact you want to use 0(h0000) to 65535(hFFFF)							
N	WORD	X, Y, M, S, T, C, D, Z, F, UW, integer							
		Setting value of counter 0(h0000) to 65535(hFFFF)							

<Ladder>

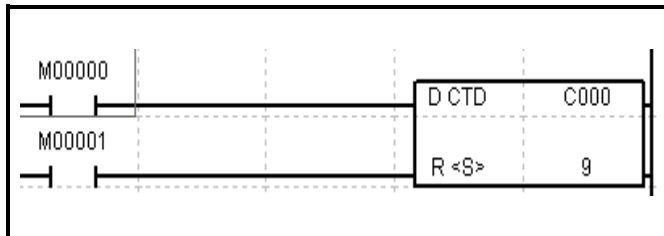

1. If the pulse signal is applied to the input rung when the reset signal is OFF, the word value of S device is decreased one by one, and then when it reaches 0, the corresponding counter contact turns ON.
2. If the reset signal is ON, the word value of S device becomes the setting value "N" .

<Time chart>

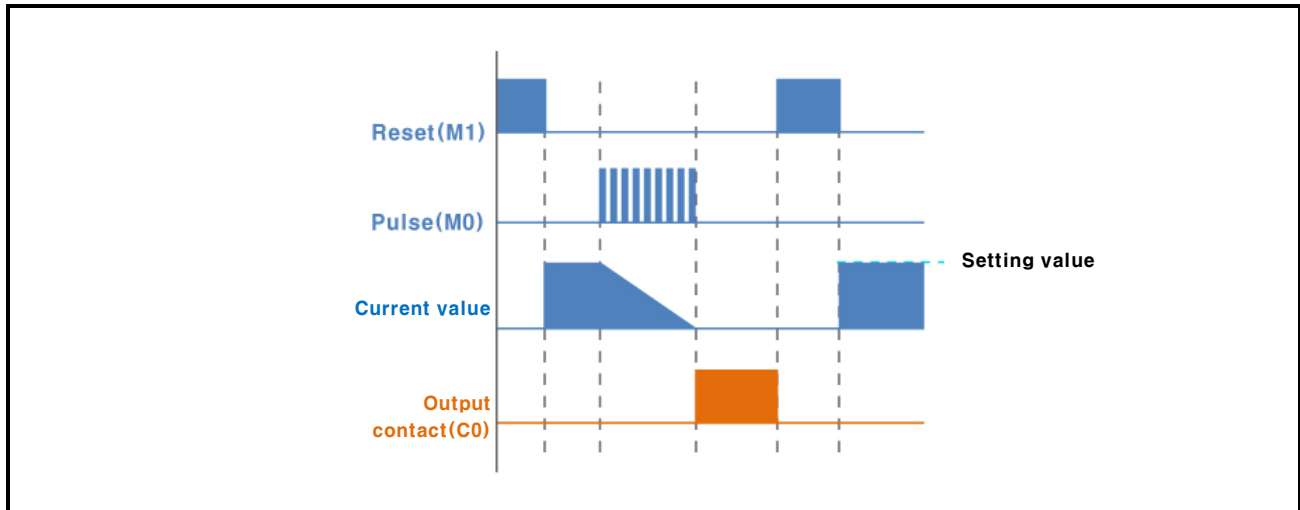

### 3.2.3 Counter instruction(CTUD)

Counter instruction	CTUD	S	N	Applicable model
				LP-S044, LP-S070
OP	DATA type	Available device / Description / Range		
S	WORD	C, UW		
		Counter contact you want to use		
		0(h0000) to 65535(hFFFF)		
N	WORD	X, Y, M, S, T, C, D, Z, F, UW, integer		
		Setting value of counter		
		0(h0000) to 65535(hFFFF)		

Error
Zero
Carry
Borrow
Step
5

<Ladder>

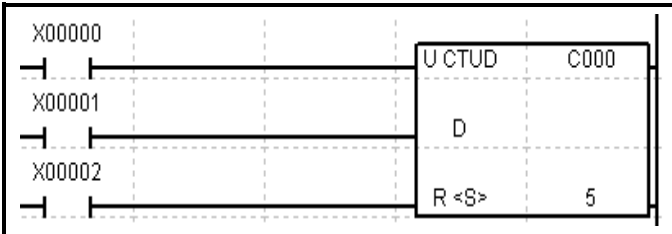

1. If the count-up pulse is applied to the input rung when the reset signal is OFF, the the word value of S device is increased one by one. Likewise, if the count-down pulse is applied to the input rung, the word value of S device is decreased one by one.
2. If the word value of S device is greater than the setting value "N", the corresponding counter contact turns ON, and if the word value of S device is less than the setting value "N", the corresponding counter contact turns OFF.
3. If the reset signal is ON, the word value of S device becomes 0.

<Time chart>

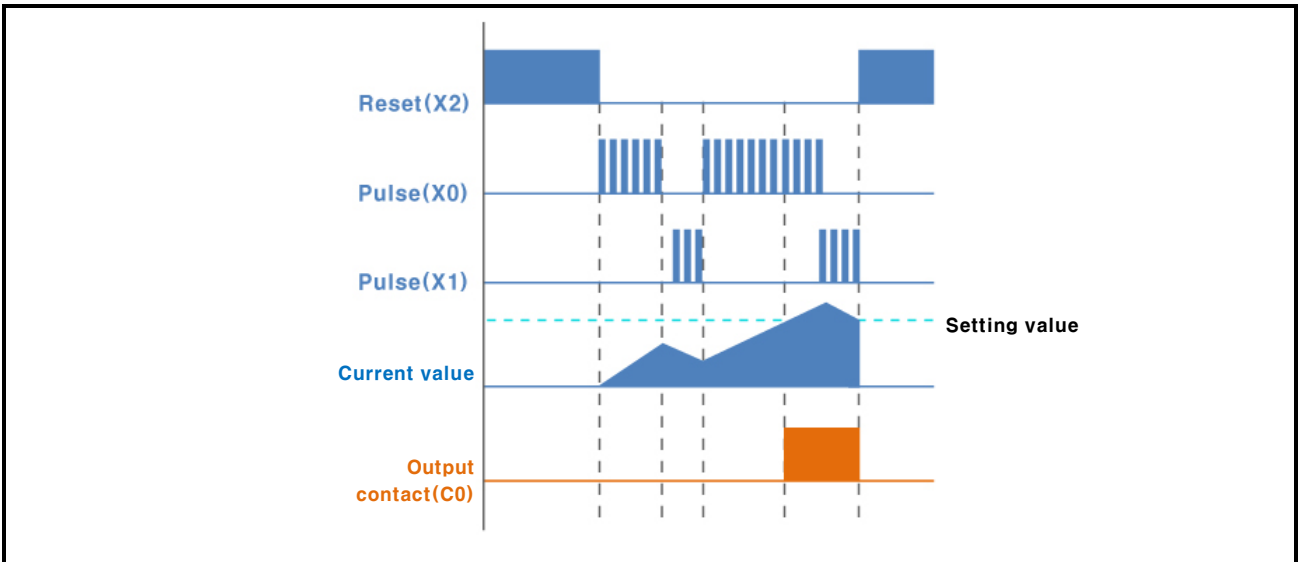

### 3.2.4 Counter instruction(CTR)

Counter instruction		CTR	S	N	Applicable model LP-S044, LP-S070				
OP	DATA type	Available device / Description / Range			Error	Zero	Carry	Borrow	Step
S	WORD	C, UW							5
		Counter contact you want to use							
		0(h0000) to 65535(hFFFF)							
N	WORD	X, Y, M, S, T, C, D, Z, F, UW, integer							
		Setting value of counter							
		0(h0000) to 65535(hFFFF)							

<Ladder>

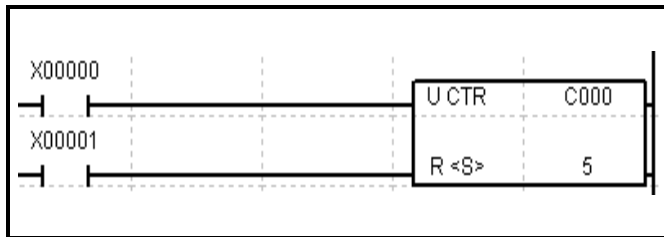

1. If the pulse signal is applied to the input rung when the reset signal is OFF, the word value of S device is increased one by one, and then when it reaches 0, the corresponding counter contact turns ON.
2. If the pulse is continuously being input even after the reset signal is ON, the word value of S device is restarted at 0 again and the corresponding counter contact becomes OFF.
3. Even if the reset signal turns ON, the word value of S device becomes 0.

<Time chart>

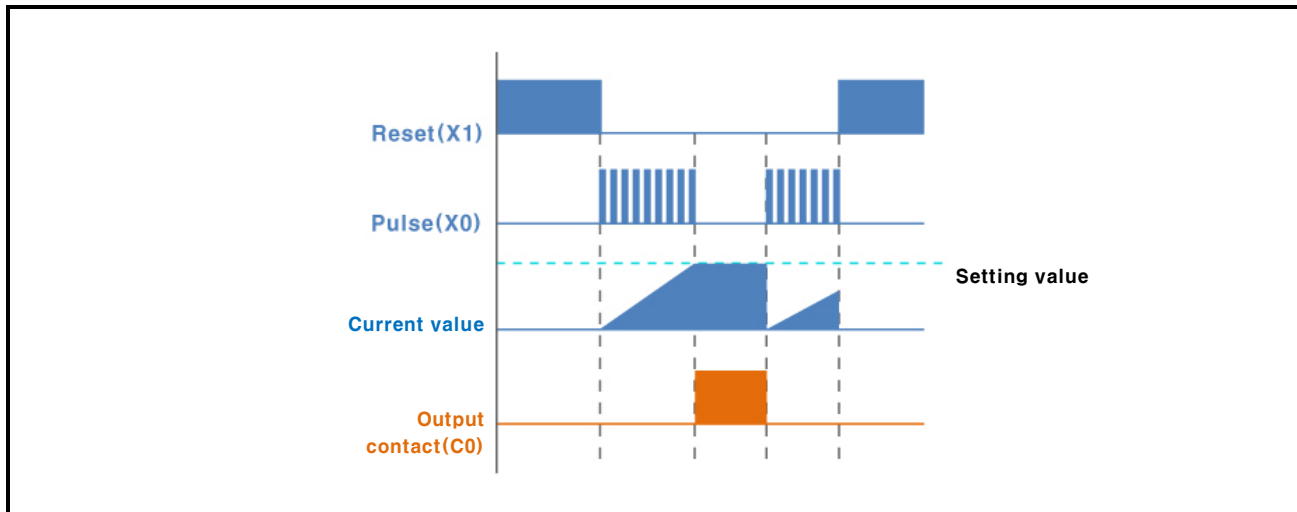

### 3.2.5 Timer instruction(TON)

Timer instruction		TON	S	N	Applicable model				
					LP-S044, LP-S070				
OP	DATA type	Available device / Description / Range			Error	Zero	Carry	Borrow	Step
S	WORD	T, UW							5
		Timer contact you want to use							
		0(h0000) to 65535(hFFFF)							
N	WORD	X, Y, M, S, T, C, D, Z, F, UW, integer							
		Setting value of timer							
		0(h0000) to 65535(hFFFF)							

<Ladder>

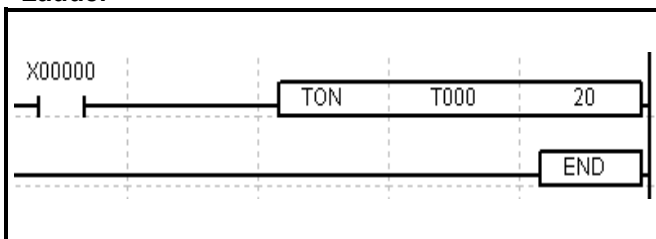

1. As soon as the input condition is ON, S device value of the timer is increased one by one and then when it reaches the setting value "N", the corresponding timer contact turns ON.
2. If the input condition becomes OFF or encounters RSTxxx instruction, the corresponding timer contact turns OFF and the current value becomes 0.

<Time chart>

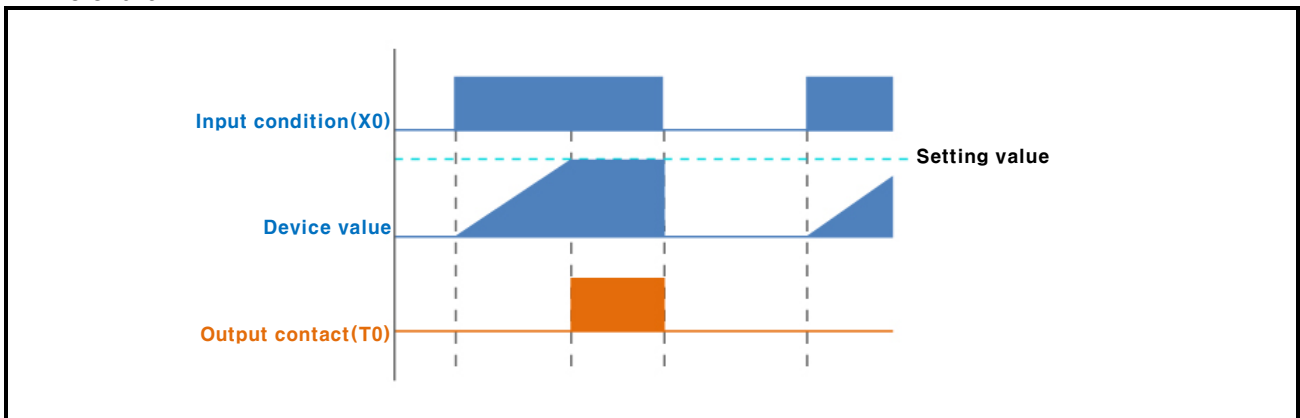

### 3.2.6 Timer instruction(TOFF)

Timer instruction		TOFF	S	N	Applicable model				
					LP-S044, LP-S070				
OP	DATA type	Available device / Description / Range			Error	Zero	Carry	Borrow	Step
S	WORD	T, UW							5
		Timer contact you want to use							
		0(h0000) to 65535(hFFFF)							
N	WORD	X, Y, M, S, T, C, D, Z, F, UW, integer							
		Setting value of timer							
		0(h0000) to 65535(hFFFF)							

<Ladder>

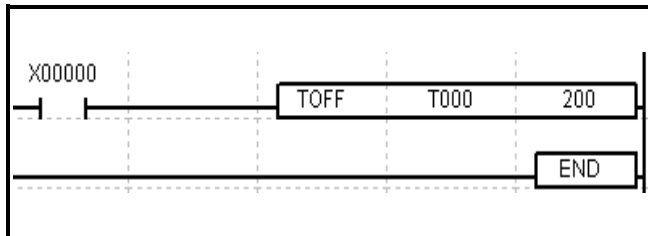

1. As soon as the input condition is ON, S device value of the timer is changed into the setting value "N" and the corresponding timer contact becomes ON.
2. If the input condition becomes OFF, the current value of the timer is decreased one by one and when it reaches "0", the corresponding timer contact becomes OFF.
3. If it encounters RST Txxxx instruction, the corresponding timer contact turns OFF and the setting value becomes "0".

<Time chart>

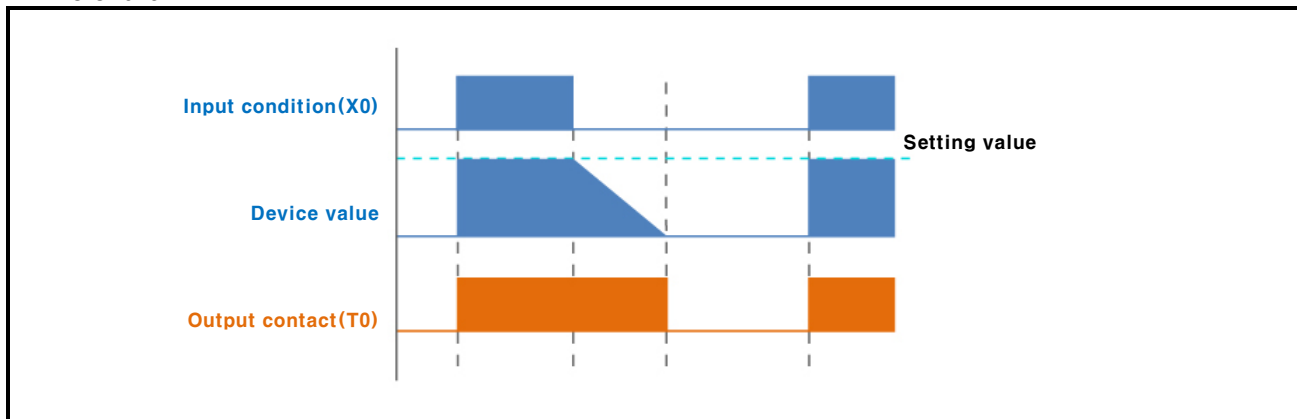

### 3.2.7 Timer instruction(TMR)

Timer instruction		TMR	S	N	Applicable model				
					LP-S044, LP-S070				
OP	DATA type	Available device / Description / Range			Error	Zero	Carry	Borrow	Step
S	WORD	T, UW							5
		Timer contact you want to use							
		0(h0000) to 65535(hFFFF)							
N	WORD	X, Y, M, S, T, C, D, Z, F, UW, integer							
		Setting value of timer							
		0(h0000) to 65535(hFFFF)							

<Ladder>

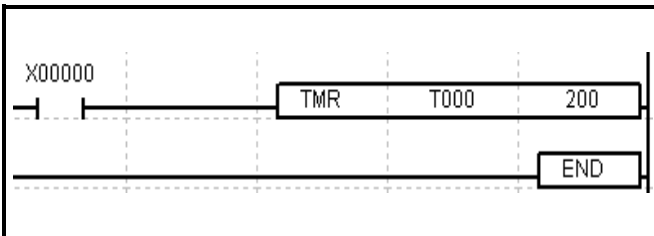

1. When the input signal is ON, the S device value of the timer is increased. And when the input signal is OFF, even if its value does not reach the setting value "N", it retains the current status of its value, and when the input signal is ON again it is increased from that value.
2. When the S device value reaches the setting value "N", the corresponding timer contact turns ON. If it encounters RST Txxxx instruction, the corresponding timer contact turns OFF and the S device value becomes "0".

<Time chart>

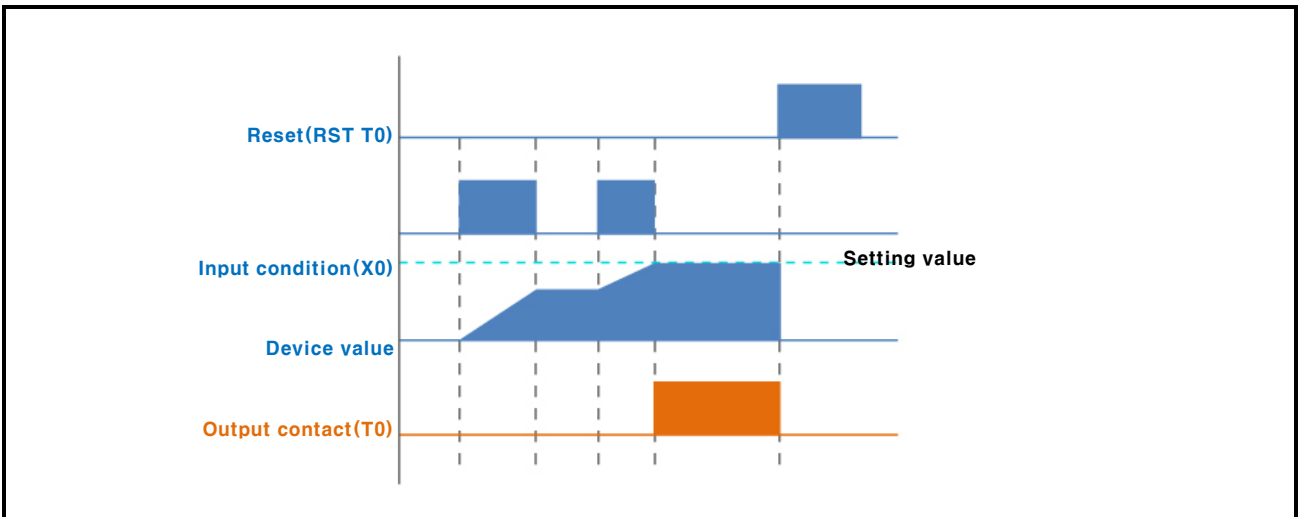

### 3.2.8 Timer instruction(TMON)

Timer instruction		TMON	S	N	Applicable model LP-S044, LP-S070				
OP	DATA type	Available device / Description / Range			Error	Zero	Carry	Borrow	Step
S	WORD	T, UW							5
		Timer contact you want to use							
		0(h0000) to 65535(hFFFF)							
N	WORD	X, Y, M, S, T, C, D, Z, F, UW, integer							
		Setting value of timer							
		0(h0000) to 65535(hFFFF)							

<Ladder>

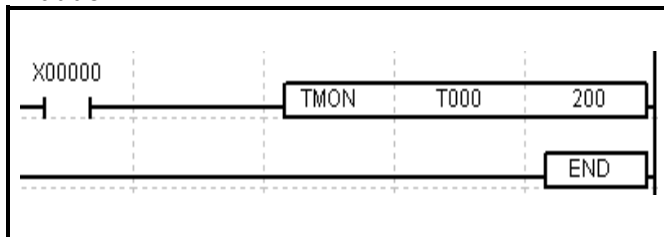

1. As soon as the input condition is ON, the corresponding timer contact turns ON, and the S device value of the timer is changed into the setting value "N" then it is decreasing.
2. Although the input condition is changed into ON/OFF in the middle of the execution, the timer is continuously operating, and when S device value of the timer reaches "0", the timer contact is to be OFF.
3. When it encounters RSTxxx instruction, the corresponding timer contact will be OFF and the S device value of the timer will be "0".

<Time chart>

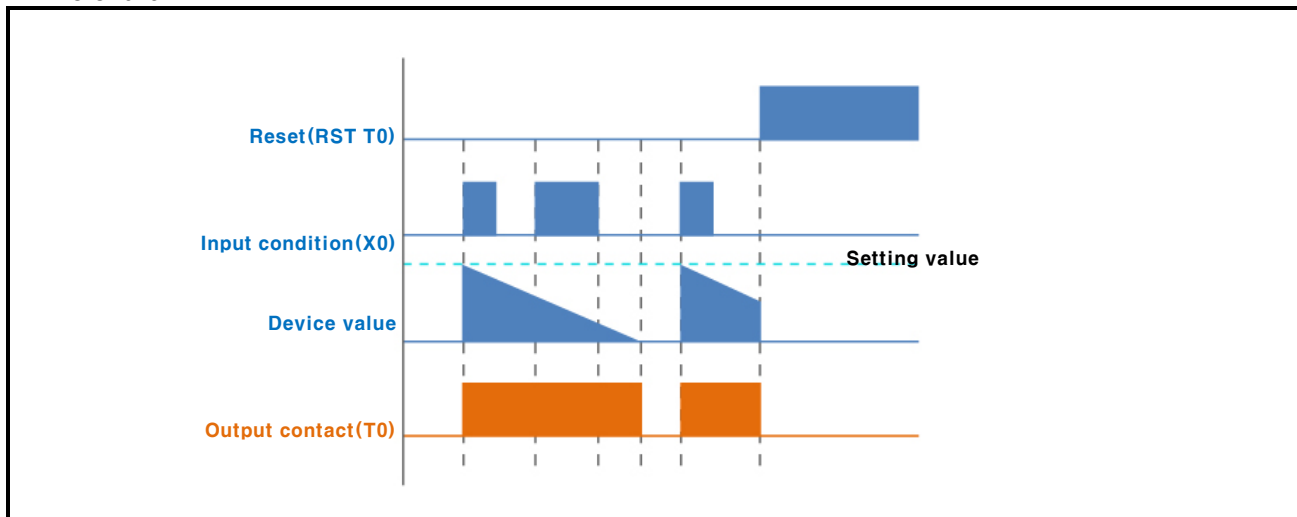



### 3.2.9 Timer instruction(TRTG)

Timer instruction		TRTG	S	N	Applicable model				
					LP-S044, LP-S070				
OP	DATA type	Available device / Description / Range			Error	Zero	Carry	Borrow	Step
S	WORD	T, UW							5
		Timer contact you want to use							
		0(h0000) to 65535(hFFFF)							
N	WORD	X, Y, M, S, T, C, D, Z, F, UW, integer							
		Setting value of timer							
		0(h0000) to 65535(hFFFF)							

<Ladder>

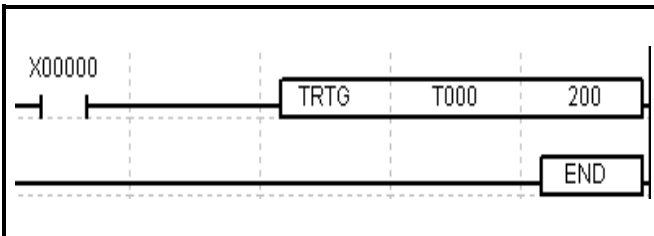

1. As soon as the input condition is ON, the corresponding timer contact turns ON and the S device value is changed into the setting value "N" then it is decreasing.
2. If the input condition turns OFF in the middle of the execution and then becomes ON, the S device value is changed into the setting value "N" again then it will be decreasing.
3. If it encounters the RST instruction, the corresponding timer contact turns OFF and the S device value is changed into "0".

<Time chart>

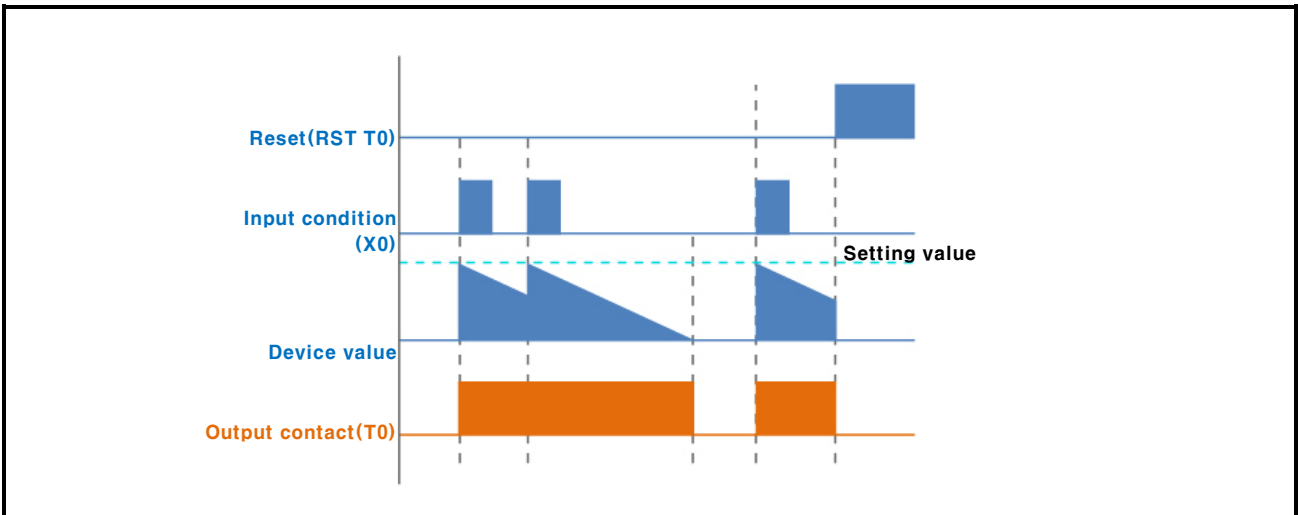

### 3.2.10 Control instruction(JMP)

Control instruction		JMP	LABEL	Applicable model					
				LP-S044, LP-S070					
OP	DATA type	Available device / Description / Range			Error	Zero	Carry	Borrow	Step
LABEL	STRING	LABEL name			☉				3
		Label for the place to jump							
		STRING							

<Ladder>

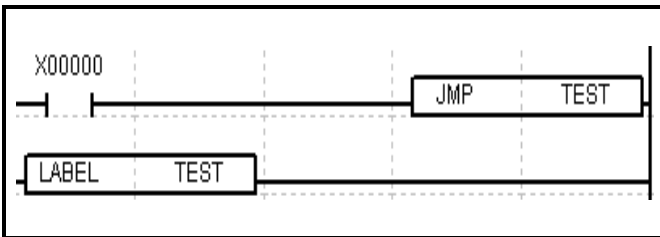

1. Jump to the place where the LABEL is matched.
2. When executing the JMP instruction, it does not process the instructions between JMP to LABEL.
3. If the LABEL does not exist, error flag occurs.

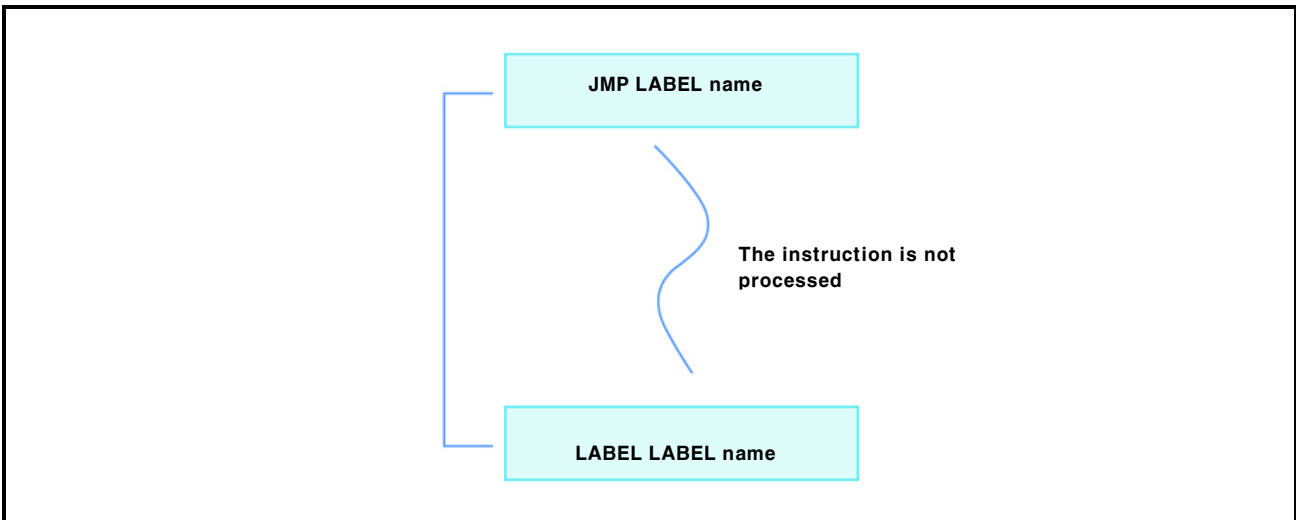

### 3.2.11 Control instruction(LABEL)

Control instruction	LABEL	Label name	Applicable model				
			LP-S044, LP-S070				
OP	DATA type	Available device / Description / Range					
Label name	STRING	LABEL name					
		Label for the place to be jumped					
		STRING					
		Error	Zero	Carry	Borrow	Step	
						3	

<Ladder>

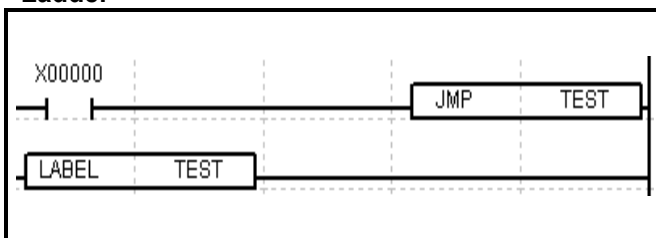

It is a destination for the JMP instruction.

### 3.2.12 Control instruction(FCALL)

Control instruction		FCALL	LABEL	Applicable model					
				LP-S044, LP-S070					
OP	DATA type	Available device / Description / Range			Error	Zero	Carry	Borrow	Step
LABEL	STRING	LABEL name			☐	☐	☐	☐	☐
		Label for the function to call							
		STRING							
				☐	☐	☐	☐	3	

<Ladder>

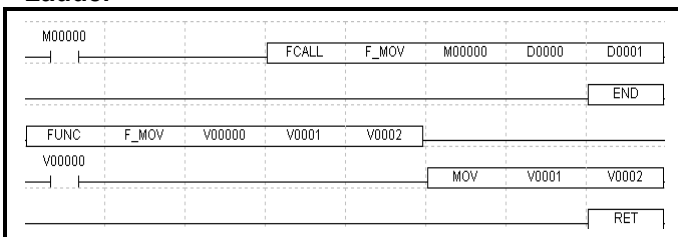

1. Calls the registered user defined function.
2. If you call an unused function, error flag occurs.
3. When you input the instruction statement, the number of operands should be matched.

### 3.2.13 Control instruction(FUNC)

Control instruction	FUNC	LABEL	Applicable model LP-S044, LP-S070				
<b>OP</b>	<b>DATA type</b>	<b>Available device / Description / Range</b>	<b>Error</b>	<b>Zero</b>	<b>Carry</b>	<b>Borrow</b>	<b>Step</b>
<b>LABEL</b>	STRING	LABEL name					
		Lable for the starting position of the function					
		STRING					3

<Ladder>

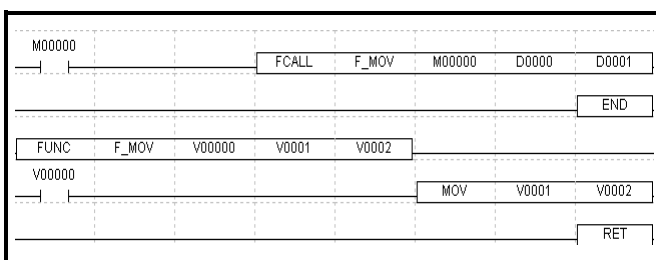

1. Represents the starting position of the user defined function.
2. It should be located behind the END sentence.
3. The virtual function device "V" is being used.
4. The RET sentence should be located in the last part of the FUNC statement.

### 3.2.14 Branch instruction(CALL)

Branch instruction		CALL	LABEL	Applicable model					
				LP-S044, LP-S070					
OP	DATA type	Available device / Description / Range			Error	Zero	Carry	Borrow	Step
LABEL	STRING	LABEL name							3
		Label for the function to call							
		STRING							

<Ladder>

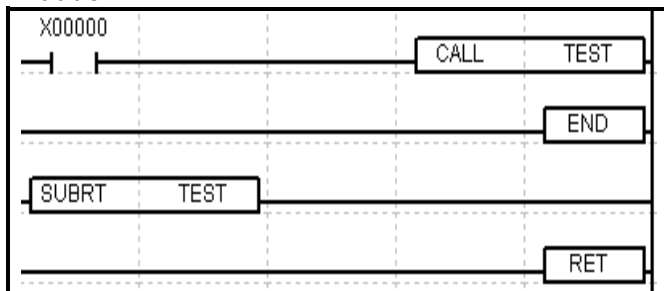

1. Calls the subroutine, such as "LABEL" name. (Executing the program between the SUBRT LABEL to RET instructions)
2. CALL LABEL can be used in duplicating, and the program between SUBRT LABEL to RET instructions should be located behind the END instruction.

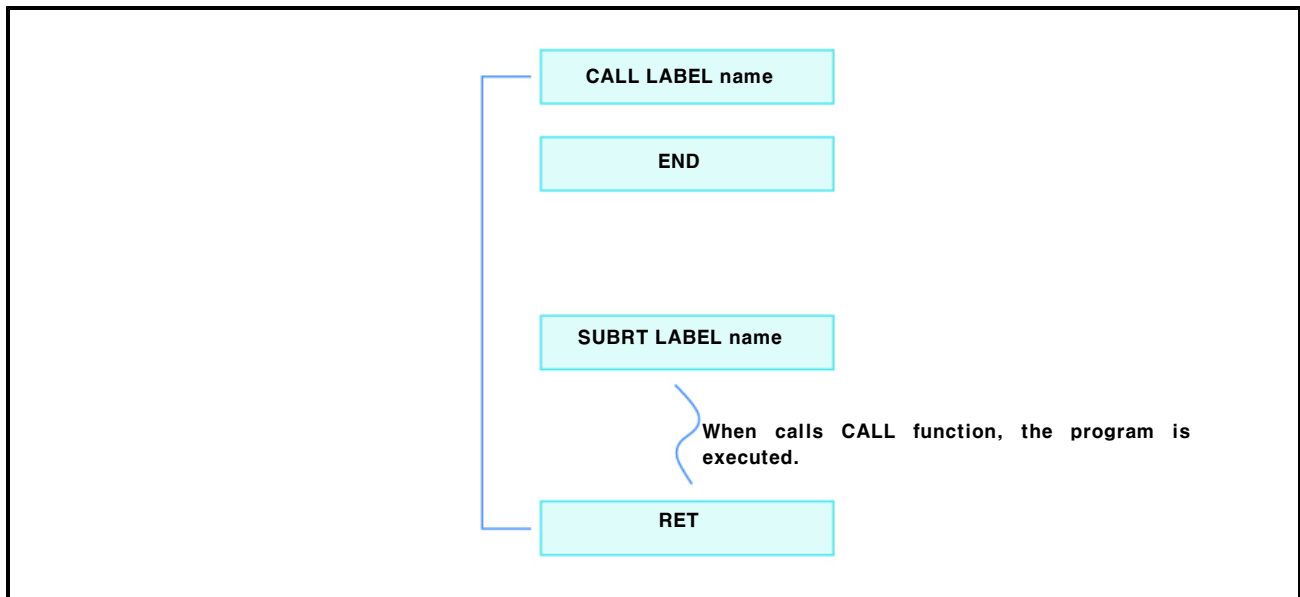

### 3.2.15 Branch instruction(SUBRT)

Branch instruction		SUBRT	LABEL	Applicable model					
				LP-S044, LP-S070					
OP	DATA type	Available device / Description / Range			Error	Zero	Carry	Borrow	Step
LABEL	STRING	LABEL name							3
		A lable for the called function							
		STRING							

<Ladder>

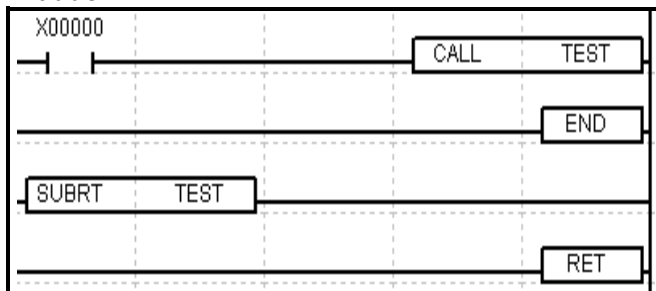

1. Displays the starting point of the CALL subroutine.
2. It should be located behind END and can not be used in duplicate.(For CALL statement, it is able to be used in duplicate)

### 3.2.16 Branch instruction(RET)

Branch  
instruction RET

Applicable model  
LP-S044, LP-S070

Exits the subroutine



### 3.2.17 Loop instruction(FOR)

Loop instruction		FOR	N	Applicable model					
					LP-S044, LP-S070				
OP	DATA type	Available device / Description / Range			Error	Zero	Carry	Borrow	Step
N	WORD	Integer							3
		0(h0000) to 65535(hFFFF)							

<Ladder>

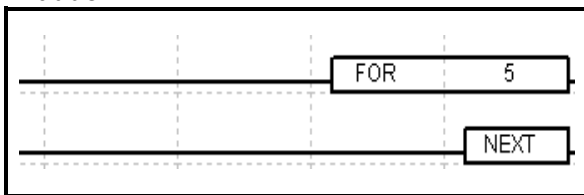

1. Sets the number of repetitions for the program with the NEXT instruction.
2. The program is repeated N times until encountering the NEXT.
3. The range for the number of repetitions is from 0 to 65535.

[Note]

The scan time can be longer than you expected therefore please use the WDT instruction in order not to exceed the setting value.

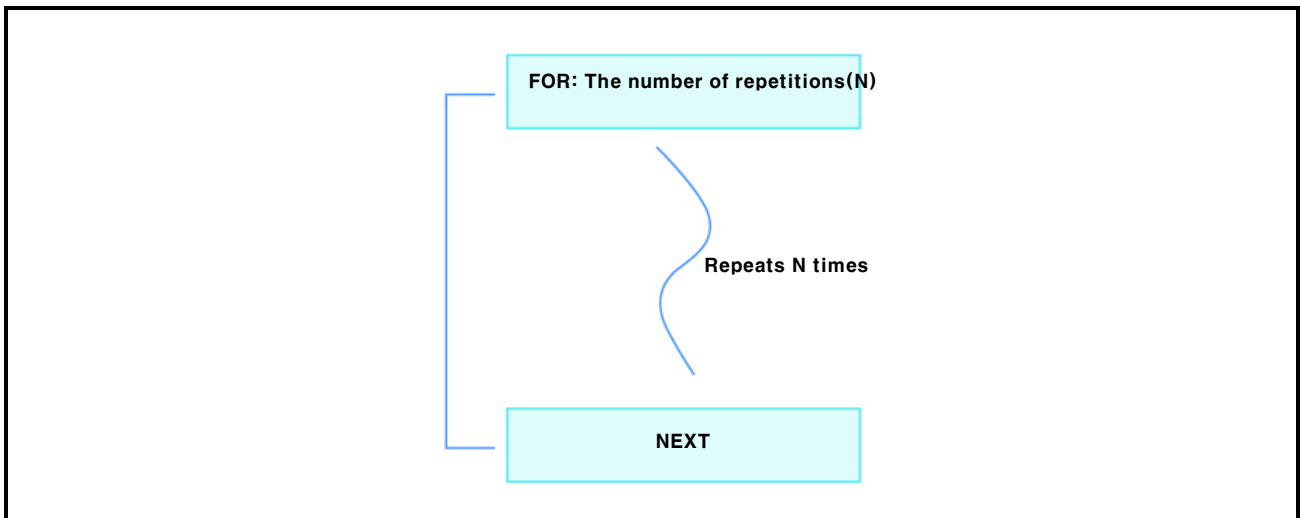

### 3.2.18 Loop instruction(NEXT)

Loop  
instruction NEXT

Applicable model  
LP-S044, LP-S070

The program is repeated from the FOR instruction to the NEXT instruction.

### 3.2.19 Loop instruction(BREAK)

Loop  
instruction BREAK

Applicable model  
LP-S044, LP-S070

Repeat operation is executed with FOR, NEXT instruction. With BREAK instruction the repeated operation stops even though repeated execution is not complete.

### 3.2.20 Master control instruction(MCS)

<b>Master control instruction</b>		<b>MCS</b>	<b>N</b>	Applicable model					
				LP-S044, LP-S070					
OP	DATA type	Available device / Description / Range			Error	Zero	Carry	Borrow	Step
<b>N</b>	Invariable number	Integer			<input type="checkbox"/>	<input type="checkbox"/>	<input type="checkbox"/>	<input type="checkbox"/>	<input type="checkbox"/>
		MCS number (0 to 7)							
		0 to 7							
				<input checked="" type="checkbox"/>				2	

<Ladder>

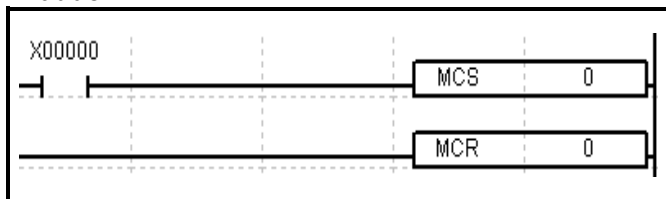

1. If the input condition of MCS is ON, the program is executed to the MCR instruction which has the same number of MCS. And if the input condition turns OFF, the program does not execute the instruction.
2. MCS number "0" has the highest priority and MCS number "15" has the lowest priority, therefore you should use them in order of priority, and should clear them in reverse order.
3. When you execute the MCR instruction, if you clear the higher priority the MCS block, which has the lower priority, is cleared too.
4. MCS or MCR instruction should be used in order of its priority.

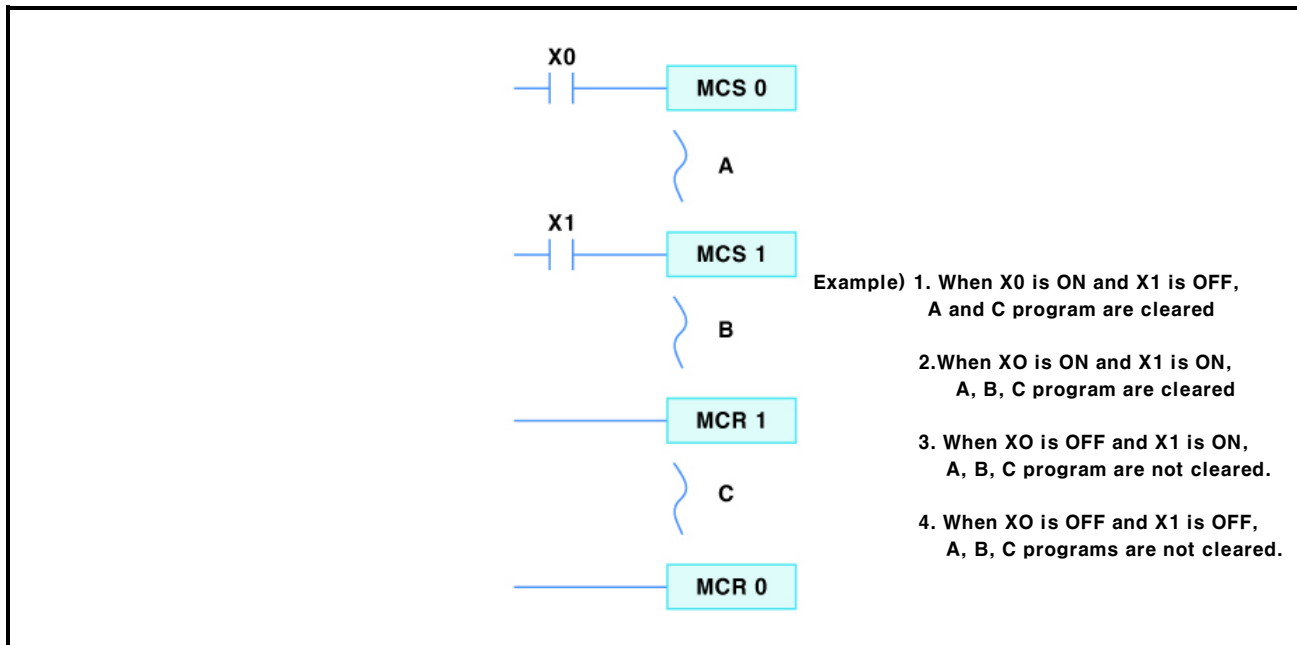

### 3.2.21 Master control instruction(MCR)

<b>Master control instruction</b>			<b>MCR</b>	<b>N</b>	Applicable model LP-S044, LP-S070				
OP	DATA type	Available device / Description / Range			Error	Zero	Carry	Borrow	Step
<b>N</b>	Invariable number	Integer							2
		MCR number (0 to 7)							
		0 to 7							

<Ladder>

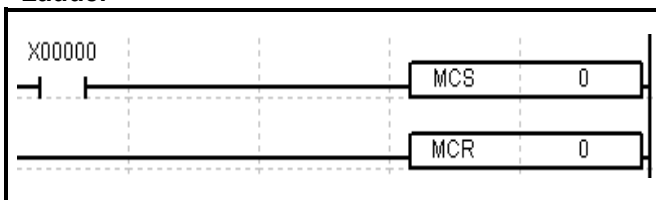

Master control reset  
Clears the registered master control by using the MCS instruction.

### 3.2.22 Interrupt instruction(EI)

<b>Interrupt instruction</b>			<b>EI</b>					Applicable model LP-S044, LP-S070	
OP	DATA type	Available device / Description / Range	Error	Zero	Carry	Borrow	Step		
		Not applicable					1		

<Ladder>

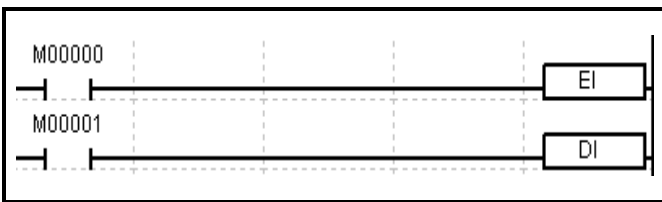

Enable Interrupt

1. Enables all interrupts.
2. Enables the entire time interrupts and external interrupts.
3. In order to use the individual interrupt, you should use ETI and EEI instructions.

### 3.2.23 Interrupt instruction(DI)

<b>Interrupt instruction</b> <b>DI</b>			Applicable model LP-S044, LP-S070				
OP	DATA type	Available device / Description / Range	Error	Zero	Carry	Borrow	Step
							1

<Ladder>

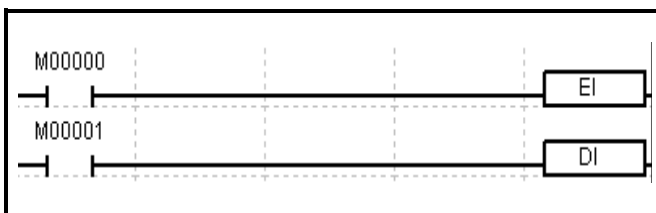

Disable Interrupt

1. Disables all interrupts.
2. Disables the entire time interrupts and external interrupts.
3. In order to disable the individual interrupt, you should use the DTI and DEI instructions.

### 3.2.24 Interrupt instruction(ETI)

Interrupt instruction		ETI	Applicable model				
			LP-S044, LP-S070				
OP	DATA type	Available device / Description / Range	Error	Zero	Carry	Borrow	Step
	Invariable number	Integer					
		0 to 7					1

<Ladder>

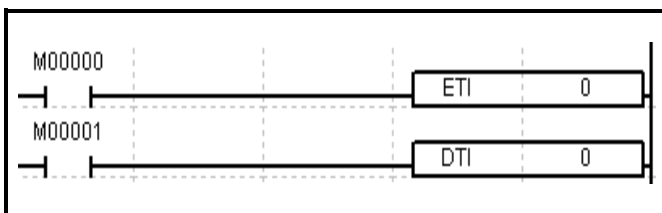

Enable Time Interrupt

1. Enables the individual time interrupt.
2. In order to use ETI, you should activate all interrupts by using EI instruction first.
3. Structure of the instructions

ETI Time Interrupt Number(0 to 7)



### 3.2.25 Interrupt instruction(EEI)

<b>Interrupt instruction</b>		<b>EEI</b>	Applicable model LP-S044, LP-S070				
OP	DATA type	Available device / Description / Range	Error	Zero	Carry	Borrow	Step
	Invariable number	Integer					
		0 to 15					1

<Ladder>

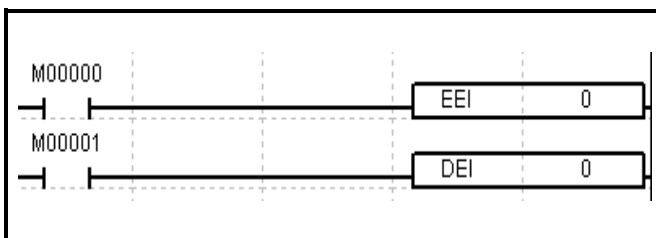

1. Enables the individual external interrupt.
2. In order to use the EEI, you should activate all interrupts by using EI instruction first.
3. Structure of the instructions  
EEI External Interrupt Number(0 to 15)

### 3.2.26 Interrupt instruction(DTI)

Interrupt instruction		DTI	Applicable model				
			LP-S044, LP-S070				
OP	DATA type	Available device / Description / Range	Error	Zero	Carry	Borrow	Step
	Invariable number	Integer					
		0 to 7					1

<Ladder>

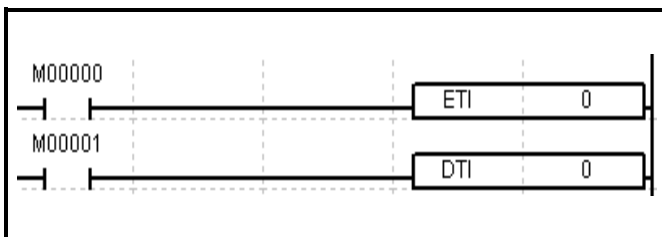

Disable Time Interrupt

1. Disables the individual time interrupt.

2. Structure of the instructions

DTI Time Interrupt Number(0 to 7)

### 3.2.27 Interrupt instruction(DEI)

<b>Interrupt instruction</b>		<b>DEI</b>	Applicable model LP-S044, LP-S070				
OP	DATA type	Available device / Description / Range	Error	Zero	Carry	Borrow	Step
	Invariable number	Integer					
		0 to 15					1

<Ladder>

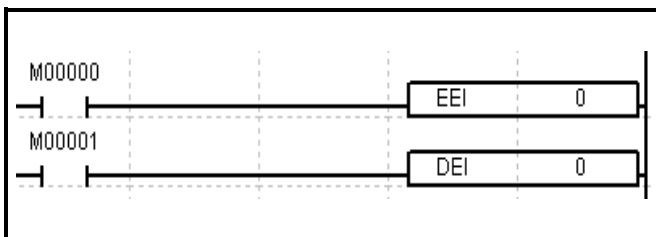

Disable External Interrupt

1. Disables the individual external interrupt.
2. Structure of the instructions

DEI External Interrupt Number(0 to 15)

### 3.2.28 Interrupt instruction(TINT)

<b>Interrupt instruction</b>		<b>TINT</b>	Applicable model LP-S044, LP-S070				
OP	DATA type	Available device / Description / Range	Error	Zero	Carry	Borrow	Step
	Invariable number	Integer 0 to 7					1

<Ladder>

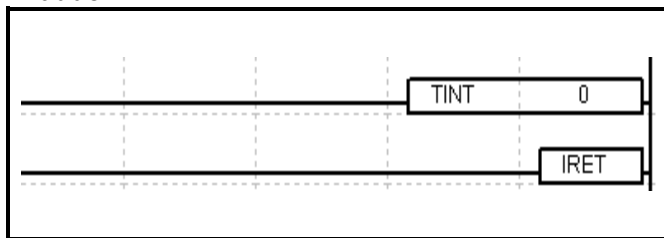

Time Interrupt

1. Represents the starting point of the time interrupt block.

2. In order to indicate the end of block, you should use the IRET instruction at the end of TINT block.

3. Structure of the instructions

TINT Time Interrupt Number(0 to 7)

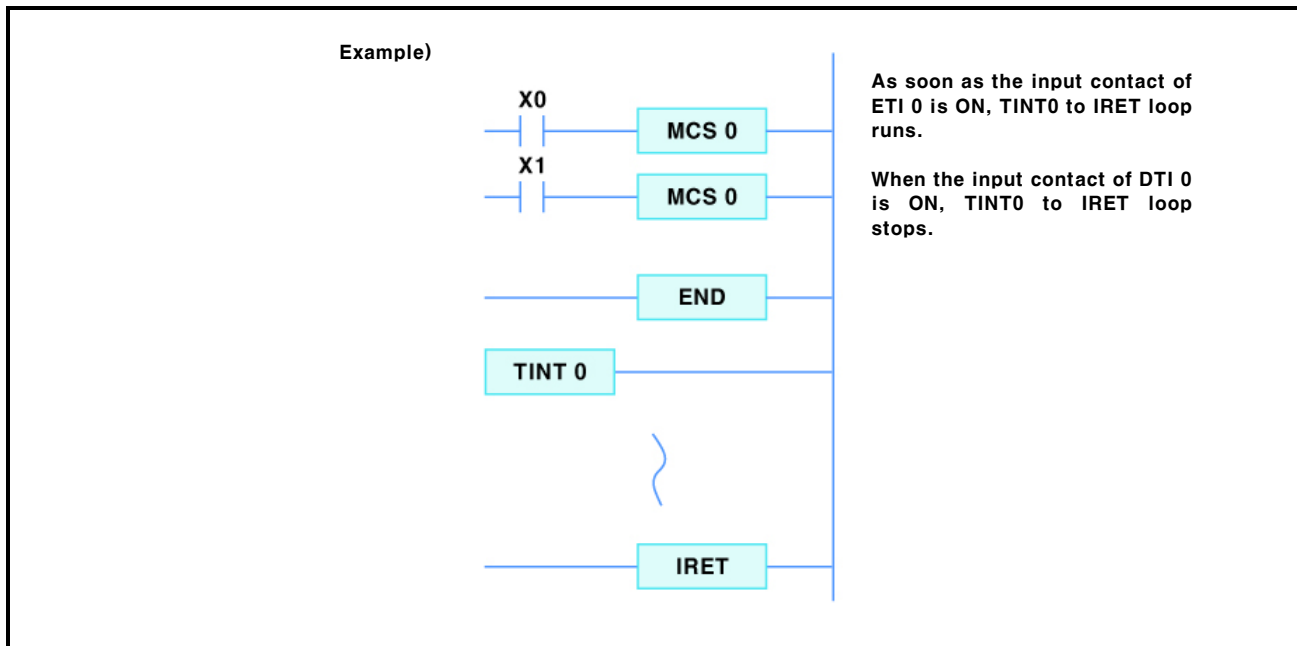

### 3.2.29 Interrupt instruction(EINT)

<b>Interrupt instruction</b> <b>EINT</b>			Applicable model LP-S044, LP-S070				
OP	DATA type	Available device / Description / Range	Error	Zero	Carry	Borrow	Step
	Invariable number	Integer					
		0 to 15					1

<Ladder>

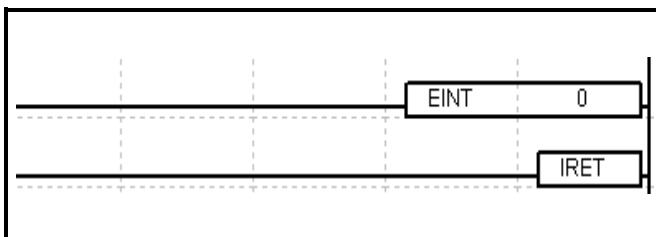

External Interrupt

1. Represent the starting point of the external interrupt block.
2. In order to indicate the end of block, you should use the IRET instruction at the end of EINT block.
3. Structure of the instructions

EINT    External Interrupt Number(0 to 15)

### 3.2.30 Interrupt instruction(IRET)

<b>Interrupt instruction</b>			<b>IRET</b>					Applicable model LP-S044, LP-S070				
OP	DATA type	Available device / Description / Range	Error	Zero	Carry	Borrow	Step					
							1					

<Ladder>

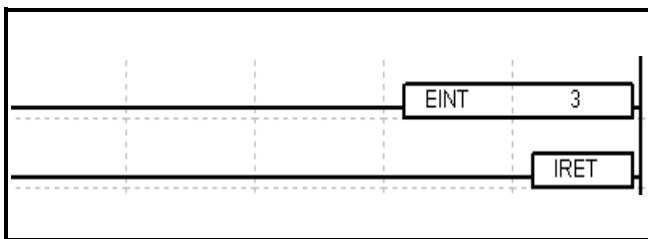

Interrupt Return

1. Represents the end of time interrupt and external interrupt blocks.

2. As below, it is generally being used with TINT or EINT instruction as a pair.

TINT to IRET

EINT to IRET

### 3.2.31 Watchdog timer(WDT)

Watchdog timer		WDT	Applicable model				
			LP-S044, LP-S070				
OP	DATA type	Available device / Description / Range	Error	Zero	Carry	Borrow	Step
							1

<Ladder>

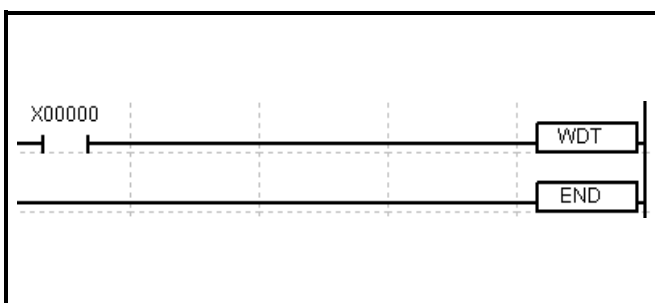

1. Resets watch dog timer during the program operation.
2. When the operation time from 0 step to END is over than max. watch dog setting time, program operation stops and WDT instruction should be used.
3. Watch dog setting value is able to change by special device.
4. When resupply power, watch dog setting value is reset as 200ms.

### 3.2.32 Input comparison instruction(LOAD=)

<p><b>Input comparison instruction</b></p>			<p><b>LOAD=</b></p>	<p><b>S1</b></p>	<p><b>S2</b></p>	<p>Applicable model</p> <p>LP-S044, LP-S070</p>				
OP	DATA type	Available device / Description / Range				Error	Zero	Carry	Borrow	Step
<b>S1</b>	INT	X, Y, F, Z, T, C, M, S, L, D, UW, integer				<input type="checkbox"/>	<input type="checkbox"/>	<input type="checkbox"/>	<input type="checkbox"/>	5
		Data or address to compare with S2 -32768(h8000) to 32767(h7FFF)								
<b>S2</b>	INT	X, Y, F, Z, T, C, M, S, L, D, UW, integer				<input type="checkbox"/>	<input type="checkbox"/>	<input type="checkbox"/>	<input type="checkbox"/>	5
		Data or address to compare with S1 -32768(h8000) to 32767(h7FFF)								

<Ladder>

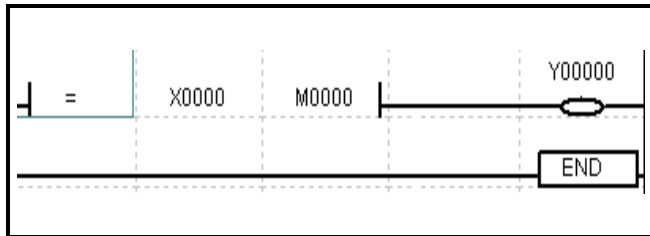

1. Compares the word value of S1 with that of S2, and if they are equal it turns ON.
2. If the word values of S1 and S2 are not equal, it turns OFF.
3. Executes the Signed comparison.  
(h8000(-32768) to hFFFF(-1) < 0 to h7FFF(32767))

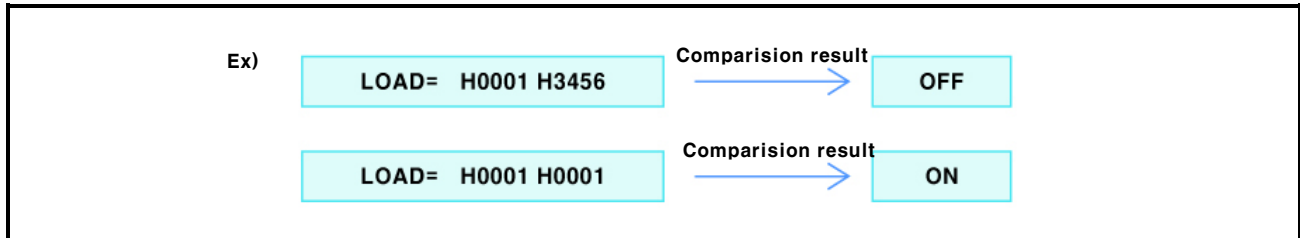



### 3.2.33 Input comparison instruction(LOAD>)

<p><b>Input comparison instruction</b></p> <p><b>LOAD&gt; S1 S2</b></p>			<p>Applicable model</p> <p>LP-S044, LP-S070</p>				
OP	DATA type	Available device / Description / Range	Error	Zero	Carry	Borrow	Step
S1	INT	X, Y, F, Z, T, C, M, S, L, D, UW, integer					
		Data or address to compare with S2					
		-32768(h8000) to 32767(h7FFF)					5
S2	INT	X, Y, F, Z, T, C, M, S, L, D, UW, integer					
		Data or address to compare with S1					
		-32768(h8000) to 32767(h7FFF)					

<Ladder>

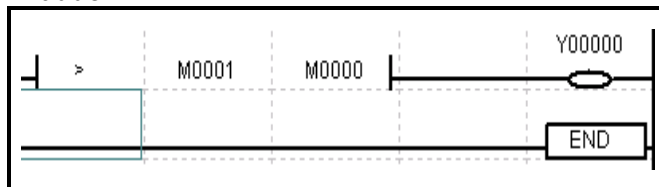

1. If the word value of S1 is greater than that of S2, it turns ON.
2. If the word value of S1 is less than or equal to that of S2, it turns OFF.
3. Execute the Signed comparison.  
(h8000(-32768) to hFFFF(-1) < 0 to h7FFF(32767))

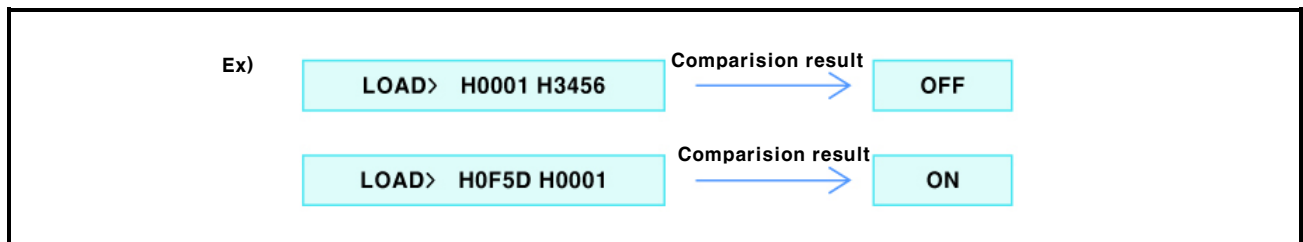

### 3.2.34 Input comparison instruction(LOAD<)

<p><b>Input comparison instruction</b></p>			<p><b>LOAD&lt;</b></p>	<p><b>S1</b></p>	<p><b>S2</b></p>	<p>Applicable model</p> <p>LP-S044, LP-S070</p>				
OP	DATA type	Available device / Description / Range				Error	Zero	Carry	Borrow	Step
<b>S1</b>	INT	X, Y, F, Z, T, C, M, S, L, D, UW, integer				<input type="checkbox"/>	<input type="checkbox"/>	<input type="checkbox"/>	<input type="checkbox"/>	5
		Data or address to compare with S2								
		-32768(h8000) to 32767(h7FFF)								
<b>S2</b>	INT	X, Y, F, Z, T, C, M, S, L, D, UW, integer				<input type="checkbox"/>	<input type="checkbox"/>	<input type="checkbox"/>	<input type="checkbox"/>	
		Data or address to compare with S1								
		-32768(h8000) to 32767(h7FFF)								

<Ladder>

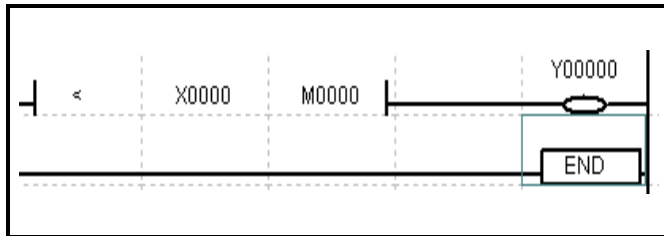

1. If the world value of S1 is less than that of S2, it turns ON.
2. If the word value of S1 is greater than or equal to that of S2, it turns OFF.
3. Executes the Signed comparison.  
(h8000(-32768) to hFFFF(-1) < 0 to hFFFF(32767))

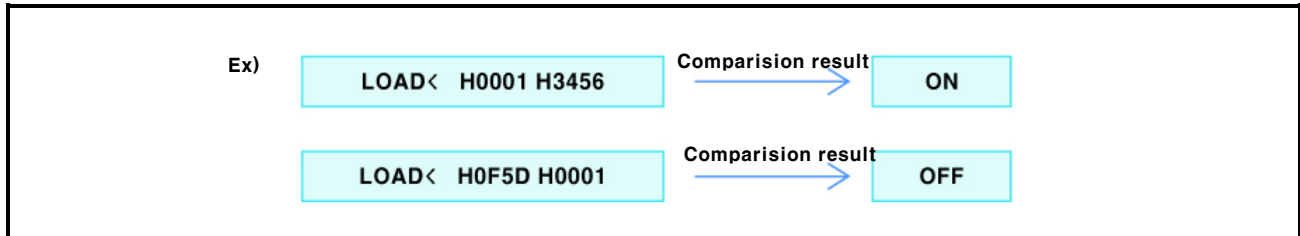

### 3.2.35 Input comparison instruction(LOAD<>)

<p><b>Input comparison instruction</b></p> <p><b>LOAD&lt;&gt; S1 S2</b></p>			<p>Applicable model</p> <p>LP-S044, LP-S070</p>				
OP	DATA type	Available device / Description / Range	Error	Zero	Carry	Borrow	Step
S1	INT	X, Y, F, Z, T, C, M, S, L, D, UW, integer					
		Data or address to compare with S2					
		-32768(h8000) to 32767(h7FFF)					5
S2	INT	X, Y, F, Z, T, C, M, S, L, D, UW, integer					
		Data or address to compare with S1					
		-32768(h8000) to 32767(h7FFF)					

<Ladder>

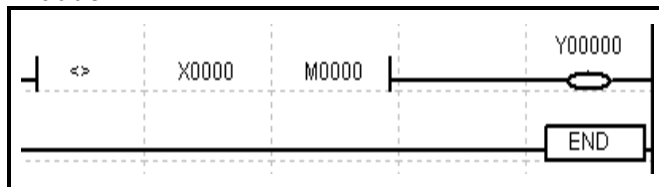

1. If the word values of S1 and S2 are not equal, it turns ON.
2. If the word values of S1 and S2 are equal, it turns OFF.
3. Executes the Signed comparison.  
(h8000(-32768) to hFFFF(-1) < 0 to h7FFF(32767))

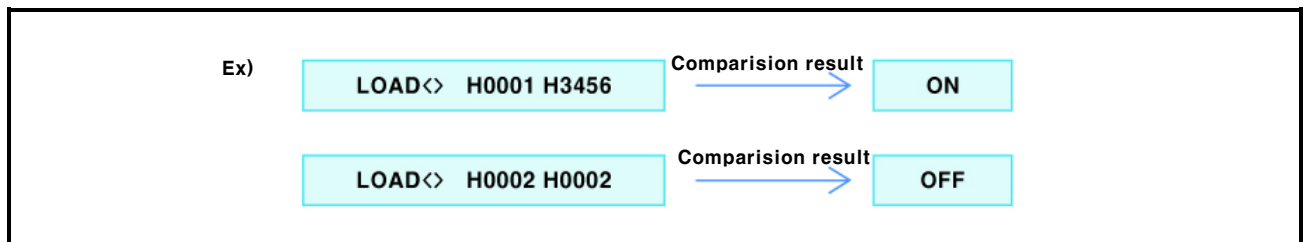

### 3.2.36 Input comparison instruction(LOAD>=)

<p><b>Input comparison instruction</b>      <b>LOAD&gt;=</b>      <b>S1</b>      <b>S2</b></p>			<p>Applicable model LP-S044, LP-S070</p>				
OP	DATA type	Available device / Description / Range	Error	Zero	Carry	Borrow	Step
<b>S1</b>	INT	X, Y, F, Z, T, C, M, S, L, D, UW, integer	<input type="checkbox"/>	<input type="checkbox"/>	<input type="checkbox"/>	<input type="checkbox"/>	5
		Data or address to compare with S2					
		-32768(h8000) to 32767(h7FFF)					
<b>S2</b>	INT	X, Y, F, Z, T, C, M, S, L, D, UW, integer	<input type="checkbox"/>	<input type="checkbox"/>	<input type="checkbox"/>	<input type="checkbox"/>	5
		Data or address to compare with S1					
		-32768(h8000) to 32767(h7FFF)					

<Ladder>

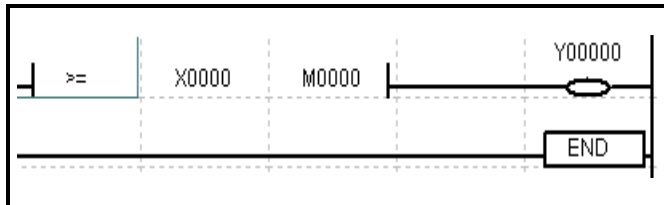

1. If the word value of S1 is less than or equal to that of S2, it turns ON.
2. If the word value of S1 is greater than that of S2, it turns OFF.
3. Executes the Signed comparison.  
(h8000(-32768) to hFFFF(-1) < 0 to h7FFF(32767))

Ex)

LOAD>= H0001 H3456	Comparison result	OFF
LOAD>= H0F5D H0001	Comparison result	ON

### 3.2.37 Input comparison instruction(LOAD<=)

<p><b>Input comparison instruction</b></p> <p><b>LOAD&lt;= S1 S2</b></p>			<p>Applicable model</p> <p>LP-S044, LP-S070</p>				
OP	DATA type	Available device / Description / Range	Error	Zero	Carry	Borrow	Step
S1	INT	X, Y, F, Z, T, C, M, S, L, D, UW, integer					
		Data or address to compare with S2					
		-32768(h8000) to 32767(h7FFF)					5
S2	INT	X, Y, F, Z, T, C, M, S, L, D, UW, integer					
		Data or address to compare with S1					
		-32768(h8000) to 32767(h7FFF)					

<Ladder>

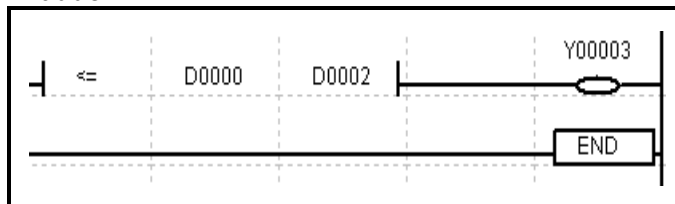

1. If the word value of S1 is less than or equal to that of S2, it turns ON.
2. If the word value of S1 is greater than that of S2, it turns OFF.
3. Executes the Signed comparison.  
(h8000(-32768) to hFFFF(-1) < 0 to h7FFF(32767))

Ex)

LOAD<= H0001 H3456	Comparison result	ON
LOAD<= HFF00 H3456	Comparison result	OFF

### 3.2.38 Input comparison instruction(DLOAD=)

<p><b>Input comparison instruction</b></p>			<p><b>DLOAD= S1 S2</b></p>	<p>Applicable model</p> <p>LP-S044, LP-S070</p>				
OP	DATA type	Available device / Description / Range						
S1	DINT	X, Y, F, Z, T, C, M, S, L, D, UW, integer	Error	Zero	Carry	Borrow	Step	5
		Data or address to compare with S2						
		-2147483648(h80000000) to 2147483647(hFFFFFFF)						
S2	DINT	X, Y, F, Z, T, C, M, S, L, D, UW, integer						
		Data or address to compare with S1						
		-2147483648(h80000000) to 2147483647(hFFFFFFF)						

<Ladder>

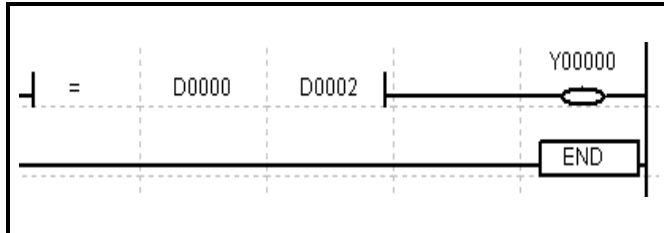

1. If the double word values of S1 and S2 are equal, it turns ON.
2. If the double word values of S1 and S2 are not equal, it turns OFF.
3. Executes the Signed comparison.  
(h80000000(-2147483648) to hFFFFFFF(-1) < 0 to h7FFFFFFF(2147483647))

Ex)

DLOAD=	H000100FF	H34561000	Comparison result	OFF
DLOAD=	H00014000	H00014000	Comparison result	ON

### 3.2.39 Input comparison instruction(DLOAD>)

<p><b>Input comparison instruction</b></p> <p><b>DLOAD&gt; S1 S2</b></p>			<p>Applicable model</p> <p>LP-S044, LP-S070</p>				
OP	DATA type	Available device / Description / Range	Error	Zero	Carry	Borrow	Step
<b>S1</b>	DINT	X, Y, F, Z, T, C, M, S, L, D, UW, integer					
		Data or address to compare with S2					
		-2147483648(h80000000) to 2147483647(hFFFFFFF)					5
<b>S2</b>	DINT	X, Y, F, Z, T, C, M, S, L, D, UW, integer					
		Data or address to compare with S1					
		-2147483648(h80000000) to 2147483647(hFFFFFFF)					

<Ladder>

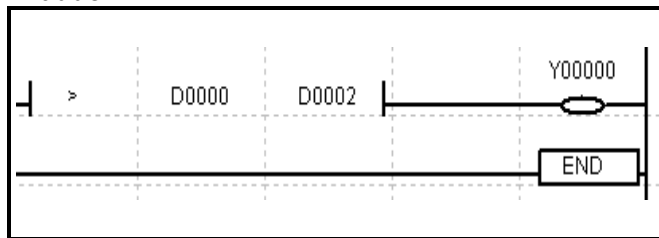

1. If the double word value of S1 is greater than that of S2, it turns ON.
2. If the double word value of S1 is less than or equal to that of S2, it turns OFF.
3. Executes the Signed comparison.  
(h80000000(-2147483648) to hFFFFFFF(-1) < 0 to h7FFFFFFF(2147483647))

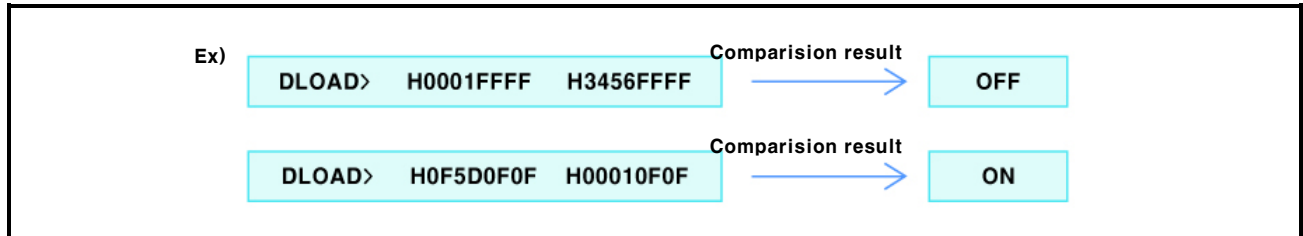

### 3.2.40 Input comparison instruction(DLOAD<)

<p><b>Input comparison instruction</b></p>			<p><b>DLOAD&lt;</b></p>	<p><b>S1</b></p>	<p><b>S2</b></p>	<p>Applicable model</p> <p>LP-S044, LP-S070</p>				
OP	DATA type	Available device / Description / Range				Error	Zero	Carry	Borrow	Step
<b>S1</b>	DINT	X, Y, F, Z, T, C, M, S, L, D, UW, integer								5
		Data or address to compare with S2								
		-2147483648(h80000000) to 2147483647(hFFFFFFF)								
<b>S2</b>	DINT	X, Y, F, Z, T, C, M, S, L, D, UW, integer								
		Data or address to compare with S1								
		-2147483648(h80000000) to 2147483647(hFFFFFFF)								

<Ladder>

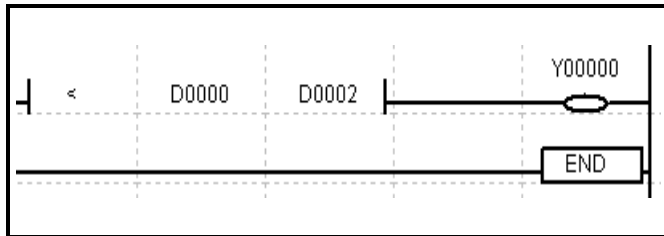

1. If the double word value of S1 is less than that of S2, it turns ON.
2. If the double word value of S1 is greater than that of S2, it turns OFF.
3. Executes the Signed comparison.  
(h80000000(-2147483648) to hFFFFFFF(-1) < 0 to hFFFFFFF(2147483647))

Ex)

<b>DLOAD&lt;</b>	<b>H00013422</b>	<b>H3456DA12</b>	Comparison result	<b>ON</b>
<b>DLOAD&lt;</b>	<b>H0F5D3321</b>	<b>H00010010</b>	Comparison result	<b>OFF</b>



### 3.2.41 Input comparison instruction(DLOAD<>)

<b>Input comparison instruction</b>			Applicable model				
<b>DLOAD&lt;&gt; S1 S2</b>			LP-S044, LP-S070				
OP	DATA type	Available device / Description / Range	Error	Zero	Carry	Borrow	Step
<b>S1</b>	DINT	X, Y, F, Z, T, C, M, S, L, D, UW, integer					
		Data or address to compare with S2					
		-2147483648(h80000000) to 2147483647(hFFFFFFF)					5
<b>S2</b>	DINT	X, Y, F, Z, T, C, M, S, L, D, UW, integer					
		Data or address to compare with S1					
		-2147483648(h80000000) to 2147483647(hFFFFFFF)					

<Ladder>

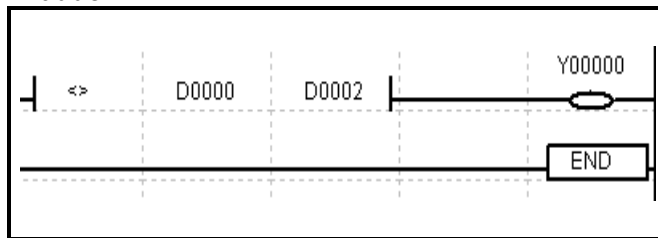

1. If the double word values of S1 and S2 are not equal, it turns ON.
2. If the double word value of S1 and S2 are equal, it turns OFF.
3. Executes the Signed comparison.  
(h80000000(-2147483648) to hFFFFFFF(-1) < 0 to hFFFFFFF(2147483647))

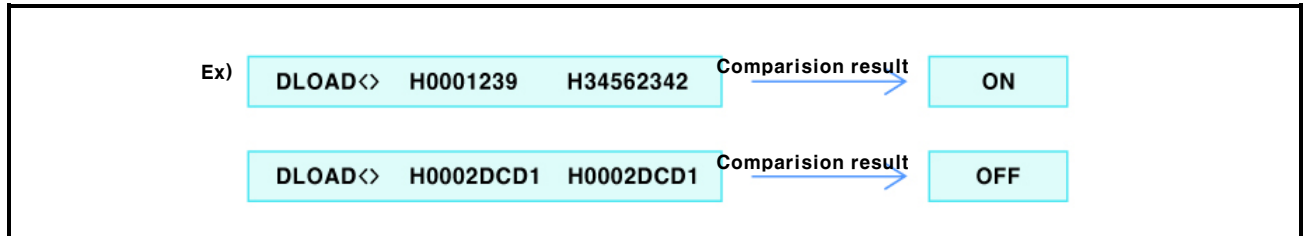

### 3.2.42 Input comparison instruction(DLOAD>=)

<p><b>Input comparison instruction</b>      <b>DLOAD&gt;= S1 S2</b></p>			<p>Applicable model LP-S044, LP-S070</p>				
OP	DATA type	Available device / Description / Range	Error	Zero	Carry	Borrow	Step
S1	DINT	X, Y, F, Z, T, C, M, S, L, D, UW, integer					
		Data or address to compare with S2					
		-2147483648(h80000000) to 2147483647(hFFFFFFF)					5
S2	DINT	integer, *, Z, X, Y, M, D, L, F, T, C, UW					
		Data or address to compare with S1					
		-2147483648(h80000000) to 2147483647(hFFFFFFF)					

<Ladder>

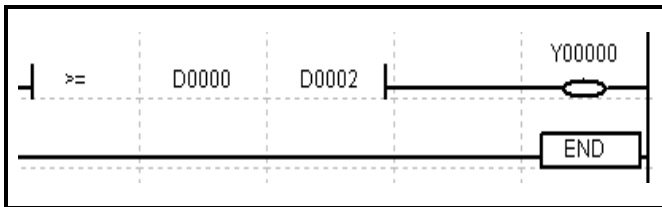

1. If the double word value of S1 is greater than or equal to that of S2, it turns ON.
2. If the double word value of S1 is less than that of S2, it turns OFF.
3. Executes the Signed comparison.  
(h80000000(-2147483648) to hFFFFFFF(-1) < 0 to h7FFFFFFF(2147483647))

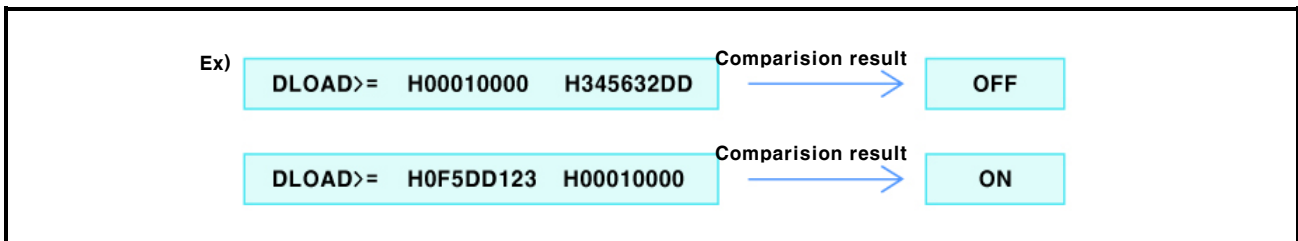

### 3.2.43 Input comparison instruction(DLOAD<=)

<p><b>Input comparison instruction</b></p> <p><b>DLOAD&lt;= S1 S2</b></p>			<p>Applicable model</p> <p>LP-S044, LP-S070</p>				
OP	DATA type	Available device / Description / Range	Error	Zero	Carry	Borrow	Step
S1	DINT	X, Y, F, Z, T, C, M, S, L, D, UW, integer					
		Data or address to compare with S2					
		-2147483648(h80000000) to 2147483647(hFFFFFFF)					5
S2	DINT	X, Y, F, Z, T, C, M, S, L, D, UW, integer					
		Data or address to compare with S1					
		-2147483648(h80000000) to 2147483647(hFFFFFFF)					

<Ladder>

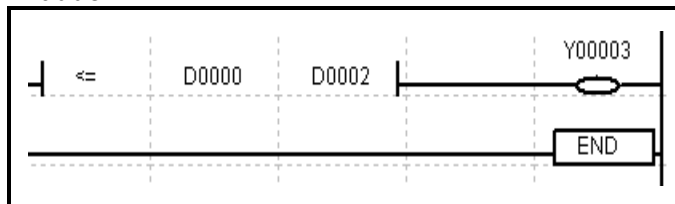

1. If the double word value of S1 is less than or equal to that of S2, it turns ON.
2. If the double word value of S1 is greater than that of S2, it turns OFF.
3. Executes the Signed comparison.  
(h80000000(-2147483648) to hFFFFFFF(-1) < 0 to h7FFFFFFF(2147483647))

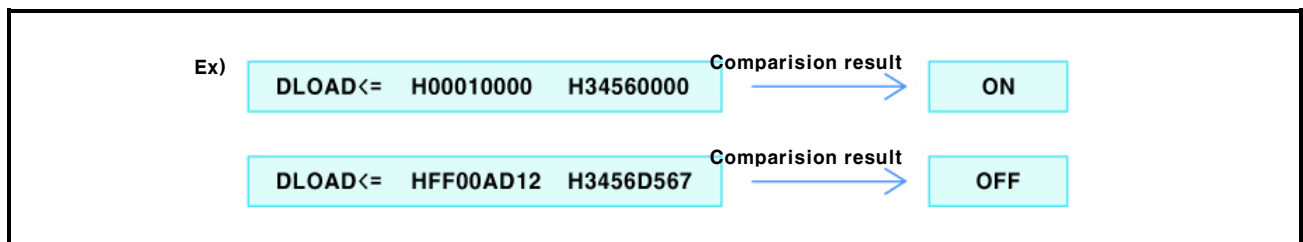

### 3.2.44 Input comparison instruction(AND=)

<p><b>Input comparison instruction</b>      <b>AND=</b>      <b>S1</b>    <b>S2</b></p>			<p>Applicable model LP-S044, LP-S070</p>				
OP	DATA type	Available device / Description / Range	Error	Zero	Carry	Borrow	Step
<b>S1</b>	INT	X, Y, F, Z, T, C, M, S, L, D, UW, integer					5
		Data or address to compare with S2 -32768(h8000) to 32767(h7FFF)					
<b>S2</b>	INT	X, Y, F, Z, T, C, M, S, L, D, UW, integer					
		Data or address to compare with S1 -32768(h8000) to 32767(h7FFF)					

<Ladder>

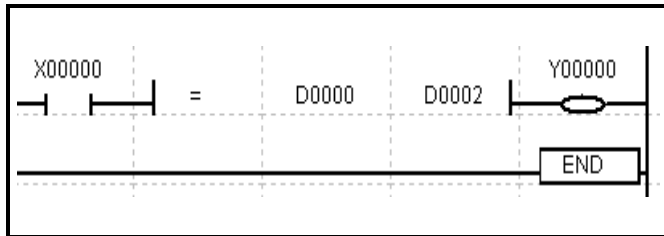

1. If the word values of S1 and S2 are equal, it turns ON.
2. If the word values of S1 and S2 are not equal, it turns OFF.
3. Executes the Signed comparison.  
(h8000(-32768) to hFFFF(-1) < 0 to h7FFF(32767))

Instruction	Condition	Comparison result
AND =	S1 = S2	ON

### 3.2.45 Input comparison instruction(AND>)

<p><b>Input comparison instruction</b></p> <p><b>AND&gt;</b>      <b>S1</b>   <b>S2</b></p>			<p>Applicable model</p> <p>LP-S044, LP-S070</p>				
OP	DATA type	Available device / Description / Range	Error	Zero	Carry	Borrow	Step
<b>S1</b>	INT	X, Y, F, Z, T, C, M, S, L, D, UW, integer	<input type="checkbox"/>	<input type="checkbox"/>	<input type="checkbox"/>	<input type="checkbox"/>	5
		Data or address to compare with S2					
		-32768(h8000) to 32767(h7FFF)					
<b>S2</b>	INT	X, Y, F, Z, T, C, M, S, L, D, UW, integer	<input type="checkbox"/>	<input type="checkbox"/>	<input type="checkbox"/>	<input type="checkbox"/>	5
		Data or address to compare with S1					
		-32768(h8000) to 32767(h7FFF)					

<Ladder>

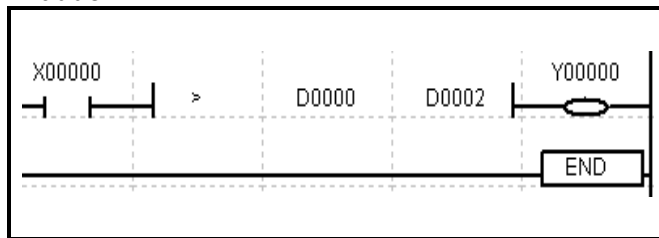

1. If the word value of S1 is greater than that of S2, it turns ON.
2. If the word value of S1 is less than or equal to that of S2, it turns OFF.
3. Executes the Signed comparison.  
(h8000(-32768) to hFFFF(-1) < 0 to h7FFF(32767))

Instruction	Condition	Comparison result
AND >	S1 > S2	ON

### 3.2.46 Input comparison instruction(AND<)

<p><b>Input comparison instruction</b></p>			<p><b>AND&lt;</b></p>	<p><b>S1 S2</b></p>	<p>Applicable model</p> <p>LP-S044, LP-S070</p>				
OP	DATA type	Available device / Description / Range			Error	Zero	Carry	Borrow	Step
<b>S1</b>	INT	X, Y, F, Z, T, C, M, S, L, D, UW, integer							5
		Data or address to compare with S2 -32768(h8000) to 32767(h7FFF)							
<b>S2</b>	INT	X, Y, F, Z, T, C, M, S, L, D, UW, integer							
		Data or address to compare with S1 -32768(h8000) to 32767(h7FFF)							

<Ladder>

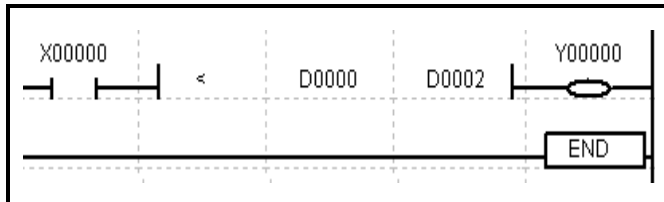

1. If the word value of S1 is less than that of S2, it turns ON.
2. If the word value of S1 is greater than or equal to that of S2, it turns OFF.
3. Executes the Signed comparison.  
(h8000(-32768) to hFFFF(-1) < 0 to h7FFF(32767))

Instruction	Condition	Comparison result
<b>AND &lt;</b>	<b>S1 &lt; S2</b>	<b>ON</b>

### 3.2.47 Input comparison instruction(AND<>)

<p><b>Input comparison instruction</b></p> <p><b>AND&lt;&gt; S1 S2</b></p>			<p>Applicable model</p> <p>LP-S044, LP-S070</p>				
OP	DATA type	Available device / Description / Range	Error	Zero	Carry	Borrow	Step
<b>S1</b>	INT	X, Y, F, Z, T, C, M, S, L, D, UW, integer					
		Data or address to compare with S2					
		-32768(h8000) to 32767(h7FFF)					5
<b>S2</b>	INT	X, Y, F, Z, T, C, M, S, L, D, UW, integer					
		Data or address to compare with S1					
		-32768(h8000) to 32767(h7FFF)					

<Ladder>

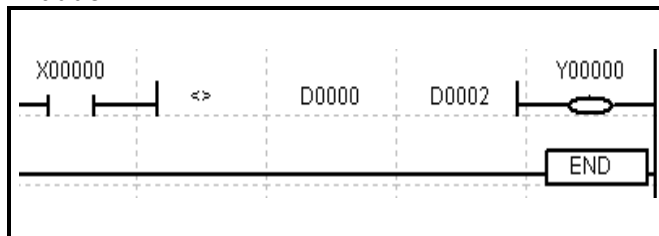

1. If the word values of S1 and S2 are not equal, it turns ON.
2. If the word values of S1 and S2 are equal, it turns OFF.
3. Executes the Signed comparison.  
(h8000(-32768) to hFFFF(-1) < 0 to h7FFF(32767))

Instruction	Condition	Comparison result
AND <>	S1 <> S2	ON

### 3.2.48 Input comparison instruction(AND>=)

<b>Input comparison instruction</b> <b>AND&gt;=</b> <b>S1</b> <b>S2</b>			Applicable model LP-S044, LP-S070				
OP	DATA type	Available device / Description / Range	Error	Zero	Carry	Borrow	Step
<b>S1</b>	INT	X, Y, F, Z, T, C, M, S, L, D, UW, integer					5
		Data or address to compare with S2 -32768(h8000) to 32767(h7FFF)					
<b>S2</b>	INT	X, Y, F, Z, T, C, M, S, L, D, UW, integer					
		Data or address to compare with S1 -32768(h8000) to 32767(h7FFF)					

<Ladder>

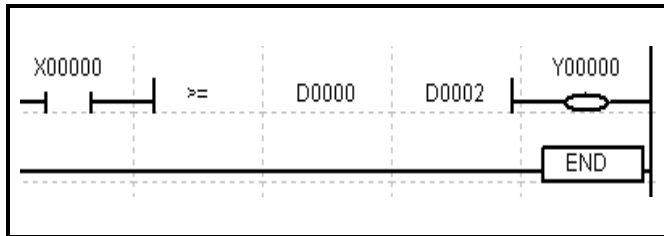

1. If the word value of S1 is greater than or equal to that of S2, it turns ON.
2. If the word value of S1 is less than that of S2, it turns OFF.
3. Executes the Signed comparison.  
(h8000(-32768) to hFFFF(-1) < 0 to h7FFF(32767))

Instruction	Condition	Comparison result
AND > =	S1 > = S2	ON



**3.2.49 Input comparison instruction(AND<=)**

<p><b>Input comparison instruction</b>      <b>AND&lt;=</b>      <b>S1</b>      <b>S2</b></p>			<p>Applicable model LP-S044, LP-S070</p>				
OP	DATA type	Available device / Description / Range	Error	Zero	Carry	Borrow	Step
<b>S1</b>	INT	X, Y, F, Z, T, C, M, S, L, D, UW, integer					
		Data or address to compare with S2					
		-32768(h8000) to 32767(h7FFF)					5
<b>S2</b>	INT	X, Y, F, Z, T, C, M, S, L, D, UW, integer					
		Data or address to compare with S1					
		-32768(h8000) to 32767(h7FFF)					

**<Ladder>**

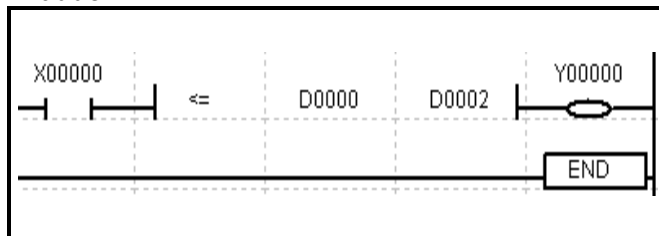

1. If the word value of S1 is less than or equal to that of S2, it turns ON.
2. If the word value of S1 is greater than that of S2, it turns OFF.
3. Executes the Signed comparison.  
(h8000(-32768) to hFFFF(-1) < 0 to h7FFF(32767))

Instruction	Condition	Comparison result
AND < =	S1 < = S2	ON

### 3.2.50 Input comparison instruction(DAND=)

<b>Input comparison instruction</b>			<b>DAND=</b>	<b>S1</b>	<b>S2</b>	Applicable model				
						LP-S044, LP-S070				
OP	DATA type	Available device / Description / Range				Error	Zero	Carry	Borrow	Step
<b>S1</b>	DINT	X, Y, F, Z, T, C, M, S, L, D, UW, integer				<input type="checkbox"/>	<input type="checkbox"/>	<input type="checkbox"/>	<input type="checkbox"/>	<input type="checkbox"/>
		Data or address to compare with S2 -2147483648(h80000000) to 2147483647(h7FFFFFFF)								
<b>S2</b>	DINT	X, Y, F, Z, T, C, M, S, L, D, UW, integer				<input type="checkbox"/>	<input type="checkbox"/>	<input type="checkbox"/>	<input type="checkbox"/>	5
		Data or address to compare with S1 -2147483648(h80000000) to 2147483647(h7FFFFFFF)								

<Ladder>

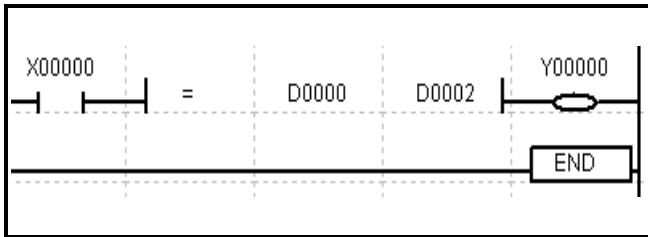

1. If the double word values of S1 and S2 are equal, it turns ON.
2. If the double word values of S1 and S2 are not equal, it turns OFF.
3. Executes the Signed comparison.  
(h80000000(-2147483648) to hFFFFFFF(-1) < 0 to h7FFFFFFF(2147483647))

Instruction	Condition	Comparison result
DAND =	S1 = S2	ON

**3.2.51 Input comparison instruction(DAND>)**

<p><b>Input comparison instruction</b></p>			<p><b>DAND&gt;</b></p>	<p><b>S1</b></p>	<p><b>S2</b></p>	<p>Applicable model</p> <p>LP-S044, LP-S070</p>				
OP	DATA type	Available device / Description / Range				Error	Zero	Carry	Borrow	Step
<b>S1</b>	DINT	X, Y, F, Z, T, C, M, S, L, D, UW, integer								5
		Data or address to compare with S2								
		-2147483648(h80000000) to 2147483647(hFFFFFFF)								
<b>S2</b>	DINT	X, Y, F, Z, T, C, M, S, L, D, UW, integer								
		Data or address to compare with S1								
		-2147483648(h80000000) to 2147483647(hFFFFFFF)								

<Ladder>

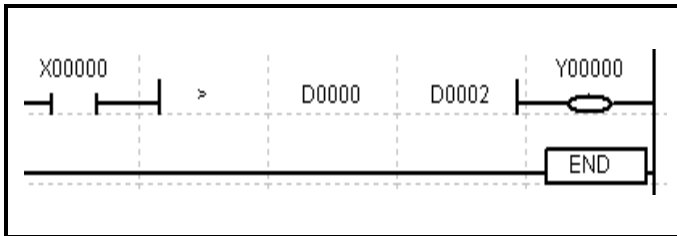

1. If the double word value of S1 is greater than that of S2, it turns ON.
2. If the double word value of S1 is less than or equal to that of S2, it turns OFF. .
3. Executes the Signed comparison.  
(h80000000(-2147483648) to hFFFFFFF(-1) < 0 to h7FFFFFFF(2147483647))

Instruction	Condition	Comparison result
DAND >	S1 > S2	ON

### 3.2.52 Input comparison instruction(DAND<)

<b>Input comparison instruction</b>		<b>DAND&lt;</b>	<b>S1</b>	<b>S2</b>	Applicable model				
					LP-S044, LP-S070				
OP	DATA type	Available device / Description / Range			Error	Zero	Carry	Borrow	Step
<b>S1</b>	DINT	X, Y, F, Z, T, C, M, S, L, D, UW, integer							5
		Data or address to compare with S2 -2147483648(h80000000) to 2147483647(hFFFFFFF)							
<b>S2</b>	DINT	X, Y, F, Z, T, C, M, S, L, D, UW, integer							
		Data or address to compare with S1 -2147483648(h80000000) to 2147483647(hFFFFFFF)							

<Ladder>

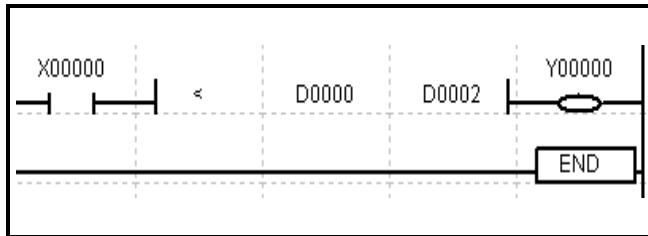

1. If the double word value of S1 is less than that of S2, it turns ON.
2. If the double word value of S1 is greater than or equal to that of S2, it turns OFF.
3. Executes the Signed comparison.  
(h80000000(-2147483648) to hFFFFFFF(-1) < 0 to h7FFFFFFF(2147483647))

Instruction	Condition	Comparison result
DAND <	S1 < S2	ON

### 3.2.53 Input comparison instruction(DAND<>)

<p><b>Input comparison instruction</b></p> <p><b>DAND&lt;&gt; S1 S2</b></p>			<p>Applicable model</p> <p>LP-S044, LP-S070</p>				
OP	DATA type	Available device / Description / Range	Error	Zero	Carry	Borrow	Step
<b>S1</b>	DINT	X, Y, F, Z, T, C, M, S, L, D, UW, integer					5
		Data or address to compare with S2					
		-2147483648(h80000000) to 2147483647(hFFFFFFF)					
<b>S2</b>	DINT	X, Y, F, Z, T, C, M, S, L, D, UW, integer					
		Data or address to compare with S1					
		-2147483648(h80000000) to 2147483647(hFFFFFFF)					

<Ladder>

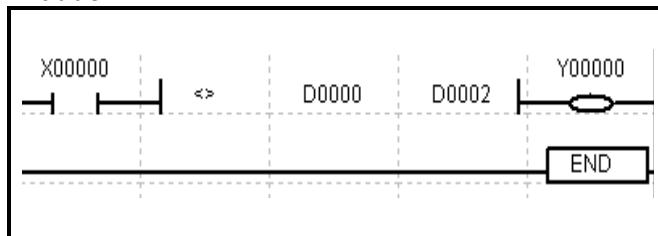

1. If the double word values of S1 and S2 are not equal, it turns ON.
2. If the double word values of S1 and S2 are equal, it turns OFF.
3. Executes the Signed comparison.  
(h80000000(-2147483648) to hFFFFFFF(-1) < 0 to h7FFFFFFF(2147483647))

Instruction	Condition	Comparison result
DAND < >	S1 < > S2	ON

### 3.2.54 Input comparison instruction(DAND>=)

<p><b>Input comparison instruction</b>      <b>DAND&gt;=</b>      <b>S1</b>      <b>S2</b></p>			<p>Applicable model LP-S044, LP-S070</p>				
OP	DATA type	Available device / Description / Range	Error	Zero	Carry	Borrow	Step
<b>S1</b>	DINT	X, Y, F, Z, T, C, M, S, L, D, UW, integer					5
		Data or address to compare with S2 -2147483648(h80000000) to 2147483647(hFFFFFFF)					
<b>S2</b>	DINT	X, Y, F, Z, T, C, M, S, L, D, UW, integer					
		Data or address to compare with S1 -2147483648(h80000000) to 2147483647(hFFFFFFF)					

<Ladder>

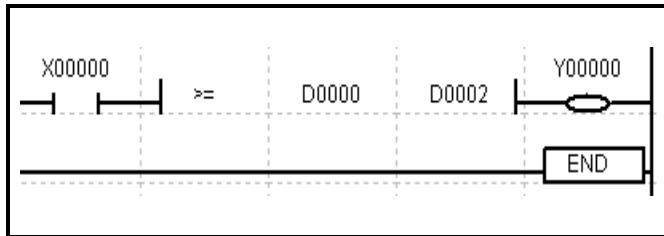

1. If the double word value of S1 is greater than or equal to that of S2, it turns ON.
2. If the double word value of S1 is less than that of S2, it turns OFF.
3. Executes the Signed comparison.  
(h80000000(-2147483648) to hFFFFFFF(-1) < 0 to h7FFFFFFF(2147483647))

Instruction	Condition	Comparison result
<b>DAND &gt; =</b>	<b>S1 &gt; = S2</b>	<b>ON</b>

### 3.2.55 Input comparison instruction(DAND<=)

<p><b>Input comparison instruction</b>      <b>DAND&lt;=</b>    <b>S1</b>    <b>S2</b></p>			<p>Applicable model LP-S044, LP-S070</p>				
OP	DATA type	Available device / Description / Range	Error	Zero	Carry	Borrow	Step
<b>S1</b>	DINT	X, Y, F, Z, T, C, M, S, L, D, UW, integer					5
		Data or address to compare with S2					
		-2147483648(h80000000) to 2147483647(hFFFFFFFF)					
<b>S2</b>	DINT	X, Y, F, Z, T, C, M, S, L, D, UW, integer					
		Data or address to compare with S1					
		-2147483648(h80000000) to 2147483647(hFFFFFFFF)					

<Ladder>

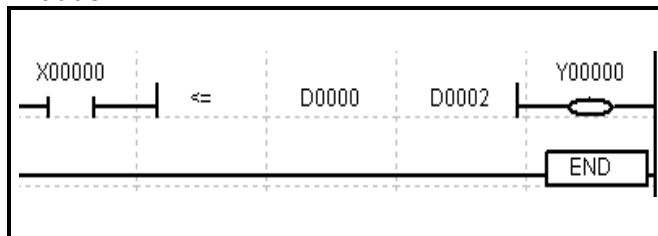

1. If the double word value of S1 is less than or equal to that of S2, it turns ON.
2. If the double word value of S1 is greater than that of S2, it turns OFF.
3. Executes the Signed comparison.  
(h80000000(-2147483648) to hFFFFFFFF(-1) < 0 to h7FFFFFFF(2147483647))

Instruction	Condition	Comparison
DAND < =	S1 < = S2	ON

### 3.2.56 Input comparison instruction(OR=)

<p><b>Input comparison instruction</b></p>			<p><b>OR=</b></p>	<p><b>S1</b></p>	<p><b>S2</b></p>	<p>Applicable model</p> <p>LP-S044, LP-S070</p>				
OP	DATA type	Available device / Description / Range				Error	Zero	Carry	Borrow	Step
<b>S1</b>	INT	X, Y, F, Z, T, C, M, S, L, D, UW, integer				<input type="checkbox"/>	<input type="checkbox"/>	<input type="checkbox"/>	<input type="checkbox"/>	5
		Data or address to compare with S2								
		-32768(h8000) to 32767(h7FFF)								
<b>S2</b>	INT	X, Y, F, Z, T, C, M, S, L, D, UW, integer				<input type="checkbox"/>	<input type="checkbox"/>	<input type="checkbox"/>	<input type="checkbox"/>	
		Data or address to compare with S1								
		-32768(h8000) to 32767(h7FFF)								

<Ladder>

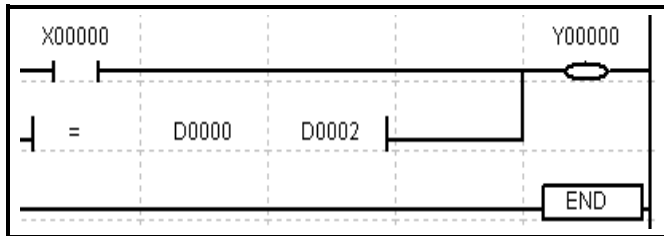

1. If the word value of S1 is equal to that of S2, it turns ON.
2. If the word value of S1 is not equal to that of S2, it turns OFF.
3. Executes the Signed comparison.  
(h8000(-32768) to hFFFF(-1) < 0 to h7FFF(32767))

Instruction	Condition	Comparison
OR =	S1 = S2	ON



**3.2.57 Input comparison instruction(OR>)**

<b>Input comparison instruction</b>			<b>OR&gt;</b>	<b>S1</b>	<b>S2</b>	Applicable model LP-S044, LP-S070				
OP	DATA type	Available device / Description / Range				Error	Zero	Carry	Borrow	Step
<b>S1</b>	INT	X, Y, F, Z, T, C, M, S, L, D, UW, integer								
		Data or address to compare with S2 -32768(h8000) to 32767(h7FFF)								
<b>S2</b>	INT	X, Y, F, Z, T, C, M, S, L, D, UW, integer								
		Data or address to compare with S1 -32768(h8000) to 32767(h7FFF)								

<Ladder>

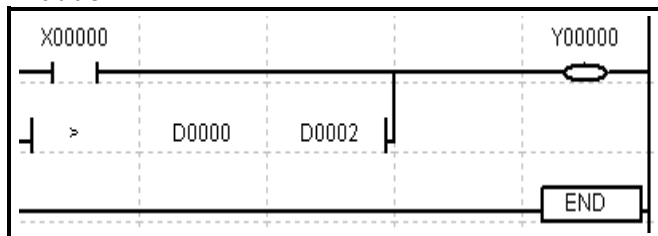

1. If the word value of S1 is greater than that of S2, it turns ON.
2. If the word value of S1 is less than or equal to that of S2, it turns OFF.
3. Executes the Signed comparison.  
(h8000(-32768) to hFFFF(-1) < 0 to h7FFF(32767))

Instruction	Condition	Comparison
OR >	S1 > S2	ON

### 3.2.58 Input comparison instruction(OR<)

<p><b>Input comparison instruction</b>      <b>OR&lt;</b>      <b>S1</b>    <b>S2</b></p>			<p>Applicable model LP-S044, LP-S070</p>				
OP	DATA type	Available device / Description / Range	Error	Zero	Carry	Borrow	Step
<b>S1</b>	INT	X, Y, F, Z, T, C, M, S, L, D, UW, integer					5
		Data or address to compare with S2 -32768(h8000) to 32767(h7FFF)					
<b>S2</b>	INT	X, Y, F, Z, T, C, M, S, L, D, UW, integer					
		Data or address to compare with S1 -32768(h8000) to 32767(h7FFF)					

<Ladder>

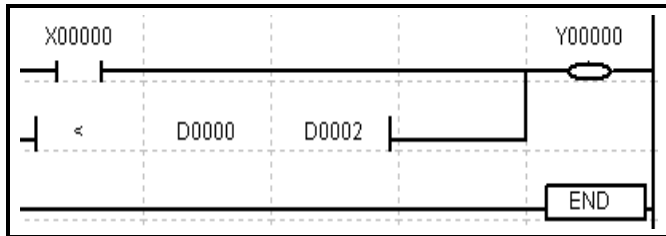

1. If the word value of S1 is less than that of S2, it turns ON.
2. If the word value of S1 is greater than or equal to that of S2, it turns OFF.
3. Executes the Signed comparison.  
(h8000(-32768) to hFFFF(-1) < 0 to h7FFF(32767))

Instruction	Condition	Comparison
OR <	S1 < S2	ON

### 3.2.59 Input comparison instruction(OR<>)

<p><b>Input comparison instruction</b></p>			<p><b>OR&lt;&gt;</b></p>	<p><b>S1 S2</b></p>	<p>Applicable model</p> <p>LP-S044, LP-S070</p>
OP	DATA type	Available device / Description / Range			
<b>S1</b>	INT	X, Y, F, Z, T, C, M, S, L, D, UW, integer	Error	Zero	Carry
		Data or address to compare with S2			
		-32768(h8000) to 32767(h7FFF)			
<b>S2</b>	INT	X, Y, F, Z, T, C, M, S, L, D, UW, integer			Step
		Data or address to compare with S1			5
		-32768(h8000) to 32767(h7FFF)			

**<Ladder>**

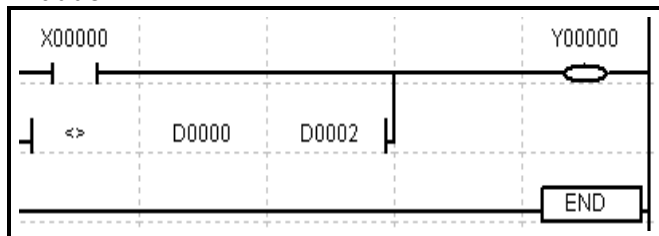

1. If the word value of S1 is not equal to that of S2, it turns ON.
2. If the word value of S1 is equal to that of S2, it turns OFF.
3. Executes the Signed comparison.  
(h8000(-32768) to hFFFF(-1) < 0 to h7FFF(32767))

Instruction	Condition	Comparison
OR < >	S1 < > S2	ON

### 3.2.60 Input comparison instruction(OR>=)

<p><b>Input comparison instruction</b>      <b>OR&gt;=</b>      <b>S1</b>    <b>S2</b></p>			<p>Applicable model LP-S044, LP-S070</p>				
OP	DATA type	Available device / Description / Range	Error	Zero	Carry	Borrow	Step
<b>S1</b>	INT	X, Y, F, Z, T, C, M, S, L, D, UW, integer					5
		Data or address to compare with S2					
		-32768(h8000) to 32767(h7FFF)					
<b>S2</b>	INT	X, Y, F, Z, T, C, M, S, L, D, UW, integer					
		Data or address to compare with S1					
		-32768(h8000) to 32767(h7FFF)					

<Ladder>

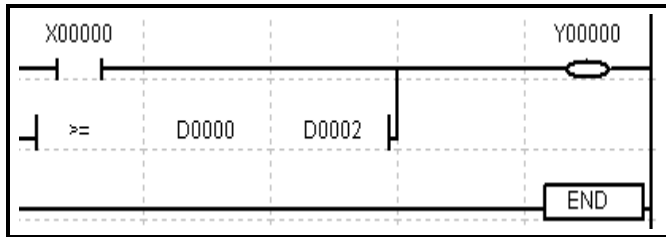

1. If the word value of S1 is greater than or equal to that of S2, it turns ON.
2. If the word value of S1 is less than that of S2, it turns OFF.
3. Executes the Signed comparison.  
(h8000(-32768) to hFFFF(-1) < 0 to h7FFF(32767))

Instruction	Condition	Comparison
OR > =	S1 > = S2	ON

### 3.2.61 Input comparison instruction(OR<=)

<p><b>Input comparison instruction</b></p>			<p><b>OR&lt;=</b></p>	<p><b>S1</b></p>	<p><b>S2</b></p>	<p>Applicable model</p> <p>LP-S044, LP-S070</p>				
OP	DATA type	Available device / Description / Range				Error	Zero	Carry	Borrow	Step
<b>S1</b>	INT	X, Y, F, Z, T, C, M, S, L, D, UW, integer								5
		Data or address to compare with S2								
		-32768(h8000) to 32767(h7FFF)								
<b>S2</b>	INT	X, Y, F, Z, T, C, M, S, L, D, UW, integer								
		Data or address to compare with S1								
		-32768(h8000) to 32767(h7FFF)								

<Ladder>

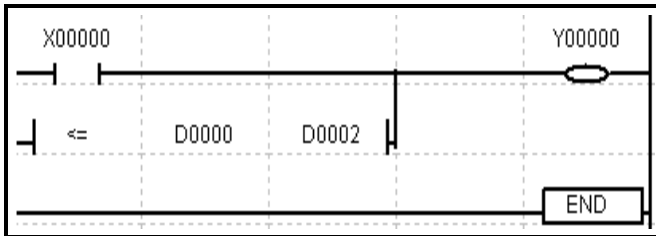

1. If the word value of S1 is less than or equal to that of S2, it turns ON.
2. If the word value of S1 is greater than that of S2, it turns OFF.
3. Executes the Signed comparison.  
(h8000(-32768) to hFFFF(-1) < 0 to h7FFF(32767))

Instruction	Condition	Comparison
OR < =	S1 < = S2	ON

### 3.2.62 Input comparison instruction(DOR=)

<p><b>Input comparison instruction</b></p>			<p><b>DOR=</b></p>	<p><b>S1</b></p>	<p><b>S2</b></p>	<p>Applicable model</p> <p>LP-S044, LP-S070</p>				
OP	DATA type	Available device / Description / Range				Error	Zero	Carry	Borrow	Step
<b>S1</b>	DINT	X, Y, F, Z, T, C, M, S, L, D, UW, integer				<input type="checkbox"/>	<input type="checkbox"/>	<input type="checkbox"/>	<input type="checkbox"/>	5
		Data or address to compare with S2								
		-2147483648(h80000000) to 2147483647(h7FFFFFFF)								
<b>S2</b>	DINT	X, Y, F, Z, T, C, M, S, L, D, UW, integer								
		Data or address to compare with S1								
		-2147483648(h80000000) to 2147483647(h7FFFFFFF)								

<Ladder>

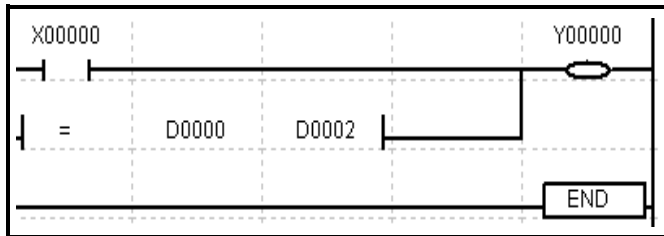

1. If the double word value of S1 is equal to that of S2, it turns ON.
2. If the double word value of S1 is not equal to that of S2, it turns OFF.
3. Executes the Signed comparison.  
(h80000000(-2147483648) to hFFFFFFF(-1) < 0 to h7FFFFFFF(2147483647))

Instruction	Condition	Comparison
DOR =	S1 = S2	ON

### 3.2.63 Input comparison instruction(DOR>)

<p><b>Input comparison instruction</b></p>			<p><b>DOR&gt;</b></p>	<p><b>S1 S2</b></p>	<p>Applicable model</p> <p>LP-S044, LP-S070</p>										
OP	DATA type	Available device / Description / Range	<table border="1"> <tr> <td>Error</td> <td>Zero</td> <td>Carry</td> <td>Borrow</td> <td>Step</td> </tr> <tr> <td></td> <td></td> <td></td> <td></td> <td>5</td> </tr> </table>			Error	Zero	Carry	Borrow	Step					5
Error	Zero	Carry	Borrow	Step											
				5											
<b>S1</b>	DINT	X, Y, F, Z, T, C, M, S, L, D, UW, integer													
		Data or address to compare with S2													
		-2147483648(h80000000) to 2147483647(h7FFFFFFF)													
<b>S2</b>	DINT	X, Y, F, Z, T, C, M, S, L, D, UW, integer													
		Data or address to compare with S1													
		-2147483648(h80000000) to 2147483647(h7FFFFFFF)													

<Ladder>

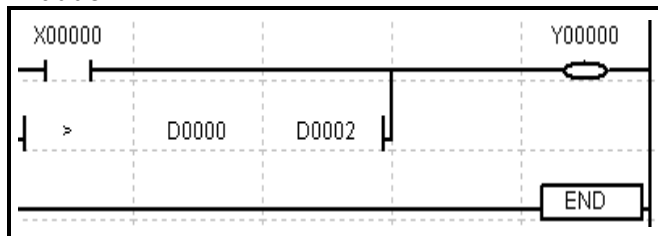

1. If the double word value of S1 is greater than that of S2, it turns ON.
2. If the double word value of S1 is less than or equal to that of S2, it turns OFF.
3. Executes the Signed comparison.  
(h80000000(-2147483648) to hFFFFFFF(-1) < 0 to h7FFFFFFF(2147483647))

Instruction	Condition	Comparison
DOR >	S1 > S2	ON

### 3.2.64 Input comparison instruction(DOR<)

<b>Input comparison instruction</b>			<b>DOR&lt;</b>	<b>S1</b>	<b>S2</b>	Applicable model LP-S044, LP-S070				
OP	DATA type	Available device / Description / Range				Error	Zero	Carry	Borrow	Step
<b>S1</b>	DINT	X, Y, F, Z, T, C, M, S, L, D, UW, integer				<input type="checkbox"/>	<input type="checkbox"/>	<input type="checkbox"/>	<input type="checkbox"/>	5
		Data or address to compare with S2 -2147483648(h80000000) to 2147483647(h7FFFFFFF)								
<b>S2</b>	DINT	X, Y, F, Z, T, C, M, S, L, D, UW, integer				<input type="checkbox"/>	<input type="checkbox"/>	<input type="checkbox"/>	<input type="checkbox"/>	5
		Data or address to compare with S1 -2147483648(h80000000) to 2147483647(h7FFFFFFF)								

<Ladder>

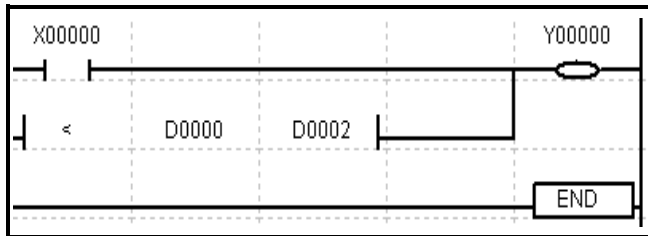

1. If the double word value of S1 is less than that of S2, it turns ON.
2. If the double word value of S1 is greater than or equal to that of S2, it turns OFF.
3. Executes the Signed comparison.  
(h80000000(-2147483648) to hFFFFFFF(-1) < 0 to h7FFFFFFF(2147483647))

Instruction	Condition	Comparison
DOR <	S1 < S2	ON



**3.2.65 Input comparison instruction(DOR<>)**

<p><b>Input comparison instruction</b></p>			<p><b>DOR&lt;&gt;</b></p>	<p><b>S1 S2</b></p>	<p>Applicable model</p> <p>LP-S044, LP-S070</p>										
OP	DATA type	Available device / Description / Range	<table border="1"> <tr> <td>Error</td> <td>Zero</td> <td>Carry</td> <td>Borrow</td> <td>Step</td> </tr> <tr> <td></td> <td></td> <td></td> <td></td> <td>5</td> </tr> </table>			Error	Zero	Carry	Borrow	Step					5
Error	Zero	Carry	Borrow	Step											
				5											
<b>S1</b>	DINT	X, Y, F, Z, T, C, M, S, L, D, UW, integer													
		Data or address to compare with S2													
		-2147483648(h80000000) to 2147483647(h7FFFFFFF)													
<b>S2</b>	DINT	X, Y, F, Z, T, C, M, S, L, D, UW, integer													
		Data or address to compare with S1													
		-2147483648(h80000000) to 2147483647(h7FFFFFFF)													

**<Ladder>**

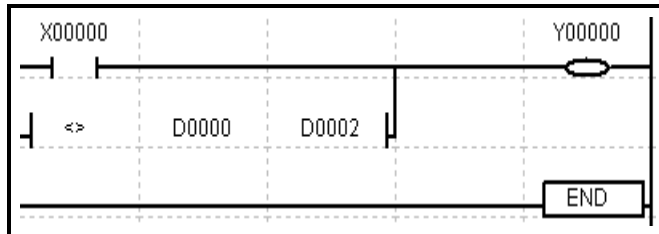

1. If the double word value of S1 is not equal to that of S2, it turns ON.
2. If the double word value of S1 is equal to that of S2, it turns OFF.
3. Executes the Signed comparison.  
(h80000000(-2147483648) to hFFFFFFF(-1) < 0 to h7FFFFFFF(2147483647))

Instruction	Condition	Comparison
DOR <>	S1 <> S2	ON

**3.2.66 Input comparison instruction(DOR>=)**

<b>Input comparison instruction</b>		<b>DOR &gt;=</b>	<b>S1</b>	<b>S2</b>	Applicable model LP-S044, LP-S070				
OP	DATA type	Available device / Description / Range			Error	Zero	Carry	Borrow	Step
<b>S1</b>	DINT	X, Y, F, Z, T, C, M, S, L, D, UW, integer			<input type="checkbox"/>	<input type="checkbox"/>	<input type="checkbox"/>	<input type="checkbox"/>	<input type="checkbox"/>
		Data or address to compare with S2 -2147483648(h80000000) to 2147483647(h7FFFFFFF)							
<b>S2</b>	DINT	X, Y, F, Z, T, C, M, S, L, D, UW, integer			<input type="checkbox"/>	<input type="checkbox"/>	<input type="checkbox"/>	<input type="checkbox"/>	<input type="checkbox"/>
		Data or address to compare with S1 -2147483648(h80000000) to 2147483647(h7FFFFFFF)							

<Ladder>

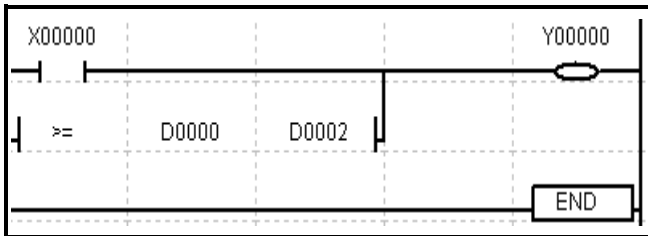

1. If the double word value of S1 is greater than or equal to that of S2, it turns ON.
2. If the double word value of S1 is less than that of S2, it turns OFF.
3. Executes the Signed comparison.  
(h80000000(-2147483648) to hFFFFFFF(-1) < 0 to h7FFFFFFF(2147483647))

Instruction	Condition	Comparison
<b>DOR &gt; =</b>	<b>S1 &gt; = S2</b>	<b>ON</b>

### 3.2.67 Input comparison instruction(DOR<=)

<p><b>Input comparison instruction</b></p> <p><b>DOR&lt;= S1 S2</b></p>			<p>Applicable model</p> <p>LP-S044, LP-S070</p>				
OP	DATA type	Available device / Description / Range	Error	Zero	Carry	Borrow	Step
S1	DINT	X, Y, F, Z, T, C, M, S, L, D, UW, integer					5
		Data or address to compare with S2 -2147483648(h80000000) to 2147483647(h7FFFFFFF)					
S2	DINT	X, Y, F, Z, T, C, M, S, L, D, UW, integer					
		Data or address to compare with S1 -2147483648(h80000000) to 2147483647(h7FFFFFFF)					

<Ladder>

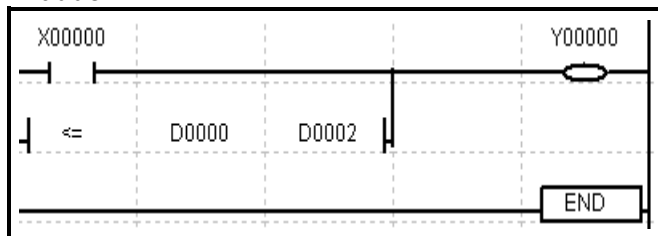

1. If the double word value of S1 is less than or equal to that of S2, it turns ON.
2. If the double word value of S1 is greater than that of S2, it turns OFF.
3. Executes the Signed comparison.  
(h80000000(-2147483648) to hFFFFFFF(-1) < 0 to h7FFFFFFF(2147483647))

Instruction	Condition	Comparison
DOR < =	S1 < = S2	ON

### 3.2.68 Comparison instruction(CMP)

Comparison instruction		CMP	S1	S2	D	Applicable model				
						LP-S044, LP-S070				
OP	DATA type	Available device / Description / Range				Error	Zero	Carry	Borrow	Step
S1	INT	X, Y, F, Z, T, C, M, S, L, D, UW, integer				<input type="checkbox"/>	<input type="checkbox"/>	<input type="checkbox"/>	<input type="checkbox"/>	7
		Data or address to compare with S2								
		-32768(h8000) to 32767(h7FFF)								
S2	INT	X, Y, F, Z, T, C, M, S, L, D, UW, integer				<input type="checkbox"/>	<input type="checkbox"/>	<input type="checkbox"/>	<input type="checkbox"/>	7
		Data or address to compare with S1								
		-32768(h8000) to 32767(h7FFF)								
D	BIT	Y, M, UB				<input type="checkbox"/>	<input type="checkbox"/>	<input type="checkbox"/>	<input type="checkbox"/>	7
		Lead address of bit device to save the comparison result								
		Not applicable								

<Ladder>

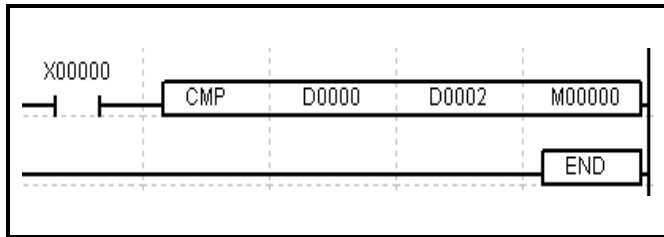

Compares the word value of S1 with that of S2. The result is as below :

1. If S1 < S2, D bit turns ON.
2. If S1 = S2, D+1 bit turns ON.
3. If S1 > S2, D+2 bit turns ON.
4. Comparison executes the Signed operation.  
(h8000(-32768) to h7FFF(-1) < 0 to h7FFF(32767))

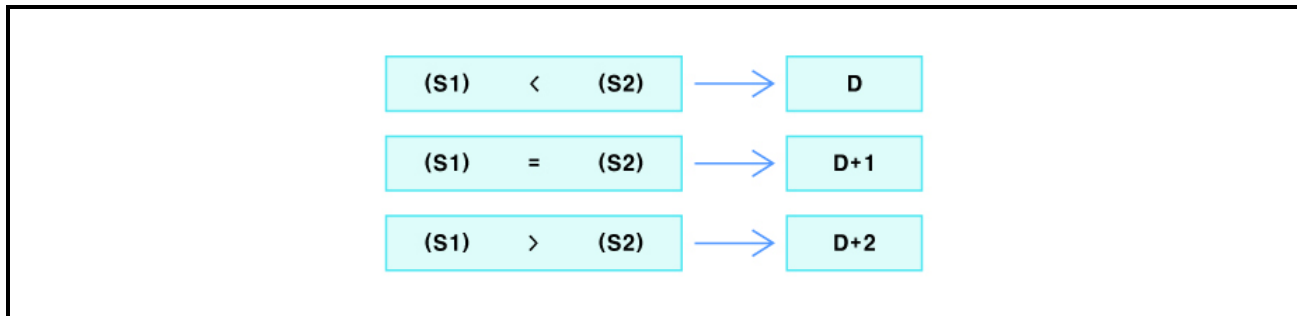

### 3.2.69 Comparison instruction(DCMP)

Comparison instruction	DCMP	S1	S2	D	Applicable model LP-S044, LP-S070					
<b>OP</b>	<b>DATA type</b>	<b>Available device / Description / Range</b>			<b>Error</b>	<b>Zero</b>	<b>Carry</b>	<b>Borrow</b>	<b>Step</b>	
<b>S1</b>	DINT	X, Y, F, Z, T, C, M, S, L, D, UW, integer								
		Data or address to compare with S2								
		-2147483648(h80000000) to 2147483647(h7FFFFFFF)								7
<b>S2</b>	DINT	X, Y, F, Z, T, C, M, S, L, D, UW, integer								
		Data or address to compare with S1								
		-2147483648(h80000000) to 2147483647(h7FFFFFFF)								
<b>D</b>	BIT	Y, M, UB								
		Lead address of bit device to save the comparison result								
		Not applicable								

<Ladder>

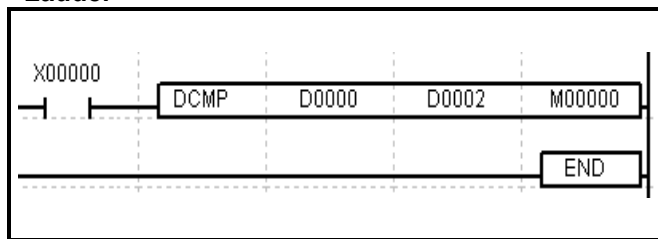

Compares the double word value of S1 with that of S2. The result is as below :

1. If S1 < S2, D bit turns ON.
2. If S1 = S2, D+1 bit turns ON.
3. If S1 > S2, D+2 bit turns ON.
4. Comparison executes the Signed operation.  
(h8000(-32768) to h7FFF(-1) < 0 to h7FFF(32767))

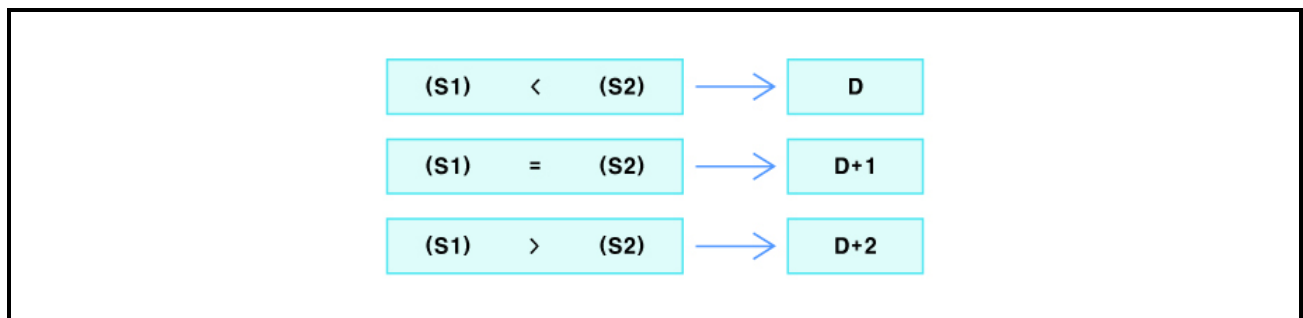

### 3.2.70 Comparison instruction(ACMP)

Comparison instruction		ACMP	S1	S2	D	N	Applicable model				
							LP-S044, LP-S070				
OP	DATA type	Available device / Description / Range					Error	Zero	Carry	Borrow	Step
S1	BIT	X, Y, F, T, C, M, UB									7
		Lead address of data or bit device to compare with S2									
		Not applicable									
S2	BIT	X, Y, F, T, C, M, UB									
		Lead address of data or bit device to compare with S1									
		Not applicable									
D	BIT	Y, M, UB									
		Lead address of bit device to save the comparison result									
		Not applicable									
N	WORD	X, Y, F, Z, T, C, M, S, L, D, UW, integer									
		The number of devices to compare									
		1 to 32									

<Ladder>

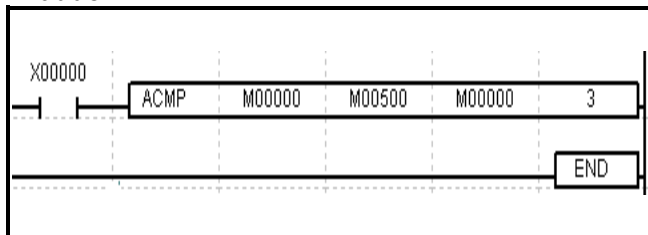

Compares the number of N bit values beginning with S1 bit with the number of N bit values beginning with S2 bit. As a result :

1. If S1 < S2, D bit turns ON.
2. If S1 == S2, D+1 bit turns ON.
3. If S1 > S2, D+2 bit turns ON.

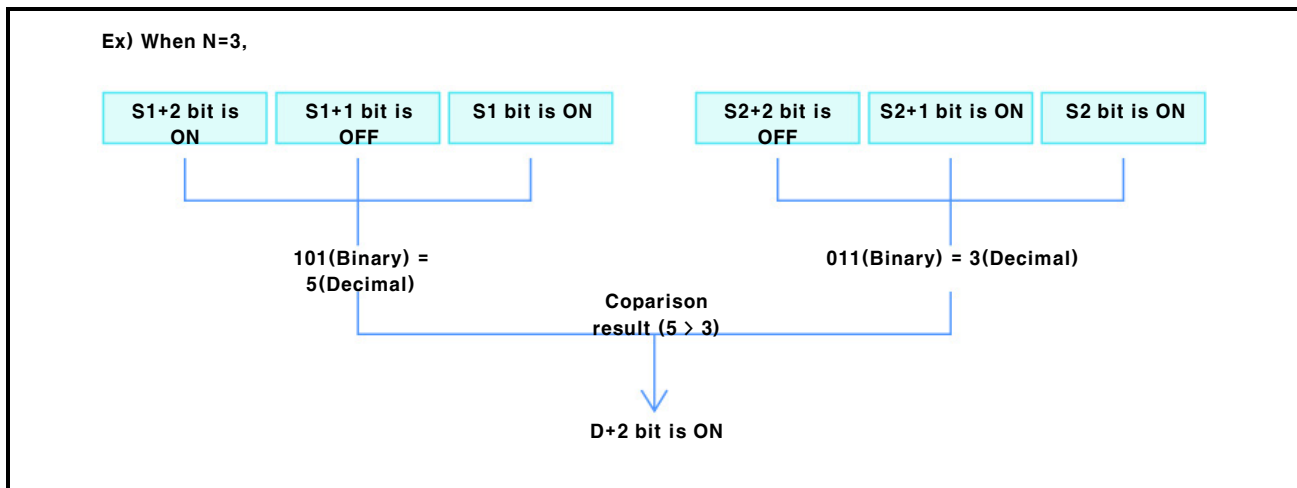

3.2.71 Comparison instruction(CMPL)

Comparison instruction		CMPL	S1	S2	D	N	Applicable model LP-S044, LP-S070				
OP	DATA type	Available device / Description / Range					Error	Zero	Carry	Borrow	Step
S1	INT	X, Y, F, Z, T, C, M, S, L, D, UW, integer									9
		Data or data address to compare with S2									
		-32768(h8000) to 32767(hFFFF)									
S2	INT	X, Y, F, Z, T, C, M, S, L, D, UW, integer									
		Data or data address to compare with S1									
		-32768(h8000) to 32767(hFFFF)									
D	BIT	Y, M, UB									
		Lead address of bit device to save comparison result									
		Not applicable									
N	WORD	X, Y, F, Z, T, C, M, S, L, D, UW, integer									
		The number of S2 data to compare with S1 data									
		As many as the number of devices remained in S1, S2 and D area									

<Ladder>

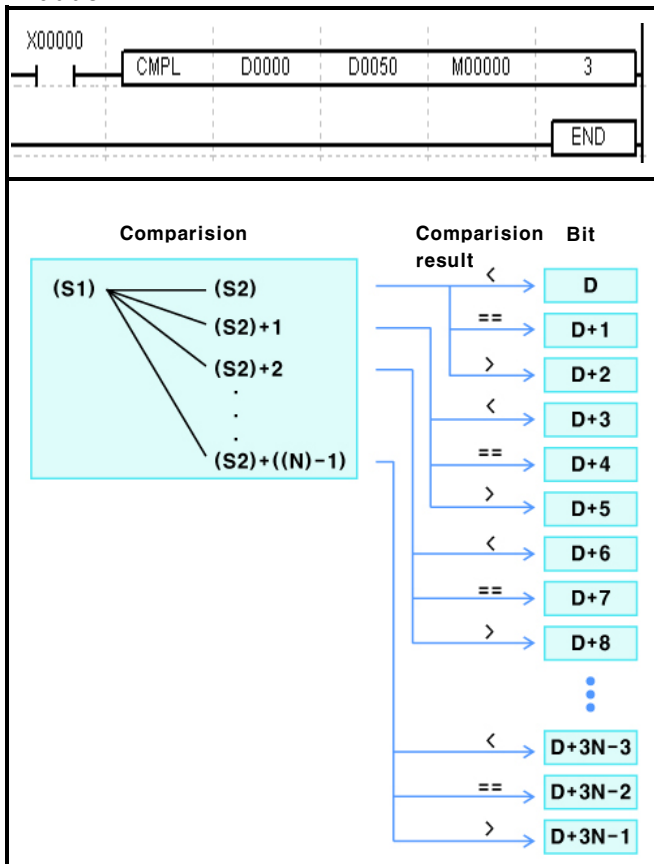

Compares the word value of S1 with the number of N word values beginning with S2 word. As a result :

1. If S1 < S2, D bit turns ON.
2. If S1 == S2, D+1 bit turns ON.
3. If S1 > S2, D+2 bit turns ON.

The comparison result of S2+1 is stored in bits from D+3 to D+5, like this way, the operation results are sequentially stored in D bits.

4. Comparison executes the Signed operation. (h8000(-32768) to hFFFF(-1) < 0 to h7FFF(32767))

### 3.2.72 Comparison instruction(DCMPL)

Comparison instruction		DCMPL	S1	S2	D	N	Applicable model				
							LP-S044, LP-S070				
OP	DATA type	Available device / Description / Range					Error	Zero	Carry	Borrow	Step
S1	DINT	X, Y, F, Z, T, C, M, S, L, D, UW, integer									6
		Data or data address to compare with S2									
		-2147483648(h80000000) to 2147483647(h7FFFFFFF)									
S2	DINT	X, Y, F, Z, T, C, M, S, L, D, UW, integer									
		Data or data address to compare with S1									
		-2147483648(h80000000) to 2147483647(h7FFFFFFF)									
D	BIT	Y, M, UB									
		Lead address of bit device to save comparison result									
		Not applicable									
N	WORD	X, Y, F, Z, T, C, M, S, L, D, UW, integer									
		The number of S2 data to compare with S1 data									
		As many as the number of devices remained in S1, S2 and D area									

<Ladder>

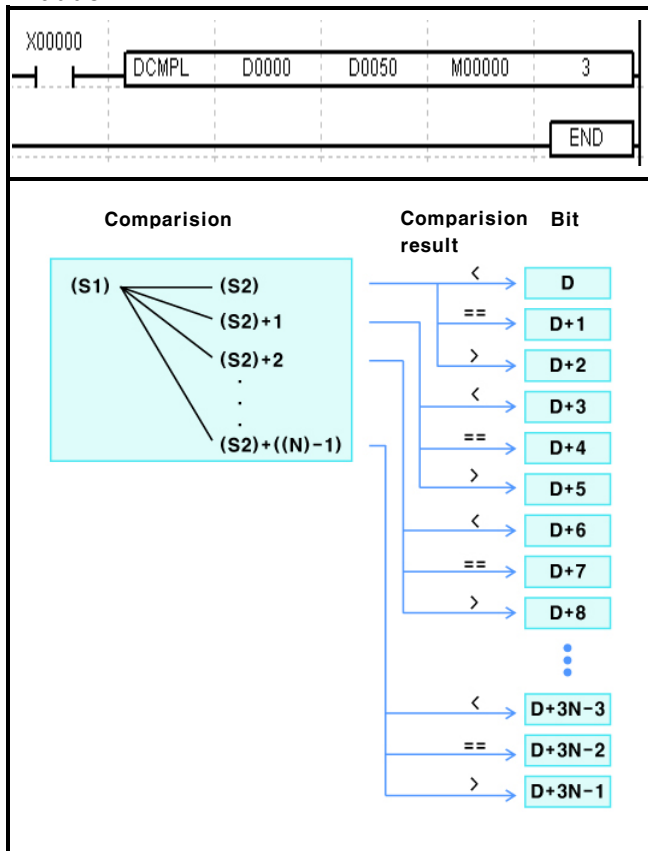

Compares the double word S1 with the number of N double words beginning with double word S2. As a result :

1. If S1 < S2, D bit turns ON.
2. If S1 == S2, D+1 bit turns ON.
3. If S1 > S2, D+2 bit turns ON.

The comparison result of S2+1 is stored in bits from D+3 to D+5, like this way, the operation results are sequentially stored in D bits.

4. Comparison executes the Signed operation. (h80000000(-2147483648) to hFFFFFFF(-1) < 0 to h7FFFFFFF(2147483647))



**3.2.73 Comparison instruction(BWCMP)**

Comparison instruction		BWCMP	S1	S2	S3	D	Applicable model LP-S044, LP-S070				
OP	DATA type	Available device / Description / Range					Error	Zero	Carry	Borrow	Step
S1	INT	X, Y, M, S, T, C, D, Z, F, UW, integer									9
		Data to compare with S2 and S3									
		-32768(h8000) to 32767(h7FFF)									
S2	INT	X, Y, M, S, T, C, D, Z, F, UW, integer									
		Data to compare with S1 and S3									
		-32768(h8000) to 32767(h7FFF)									
S3	INT	X, Y, M, S, T, C, D, Z, F, UW, integer									
		Data to compare with S1 and S2									
		-32768(h8000) to 32767(h7FFF)									
D	BIT	Y, M, UB									
		Bit device address to save comparison result									
		Not applicable									

**<Ladder>**

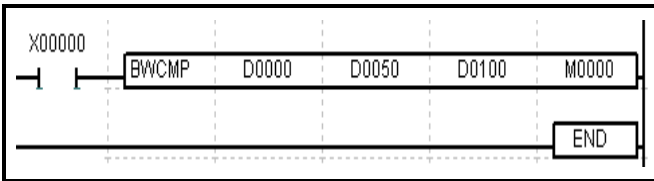

- Compare word value of S3 with the limited area between S1 and S2 word values. As a result :
1. If the value of S3 is less than the smaller value of the two(S1, S2), D bit turns ON.
  2. If the value of S3 is equal to the smaller value of the two, D+1 bit turns ON.
  3. If the value of S3 is located between the two values, D+2 bit turns ON.
  4. If the value of S3 is equal to the larger value of the two, D+3 bit turns ON.
  5. If the value of S3 is greater than the larger value of the two, D+4 bit turns ON.
  6. Comparison executes the Signed operation.

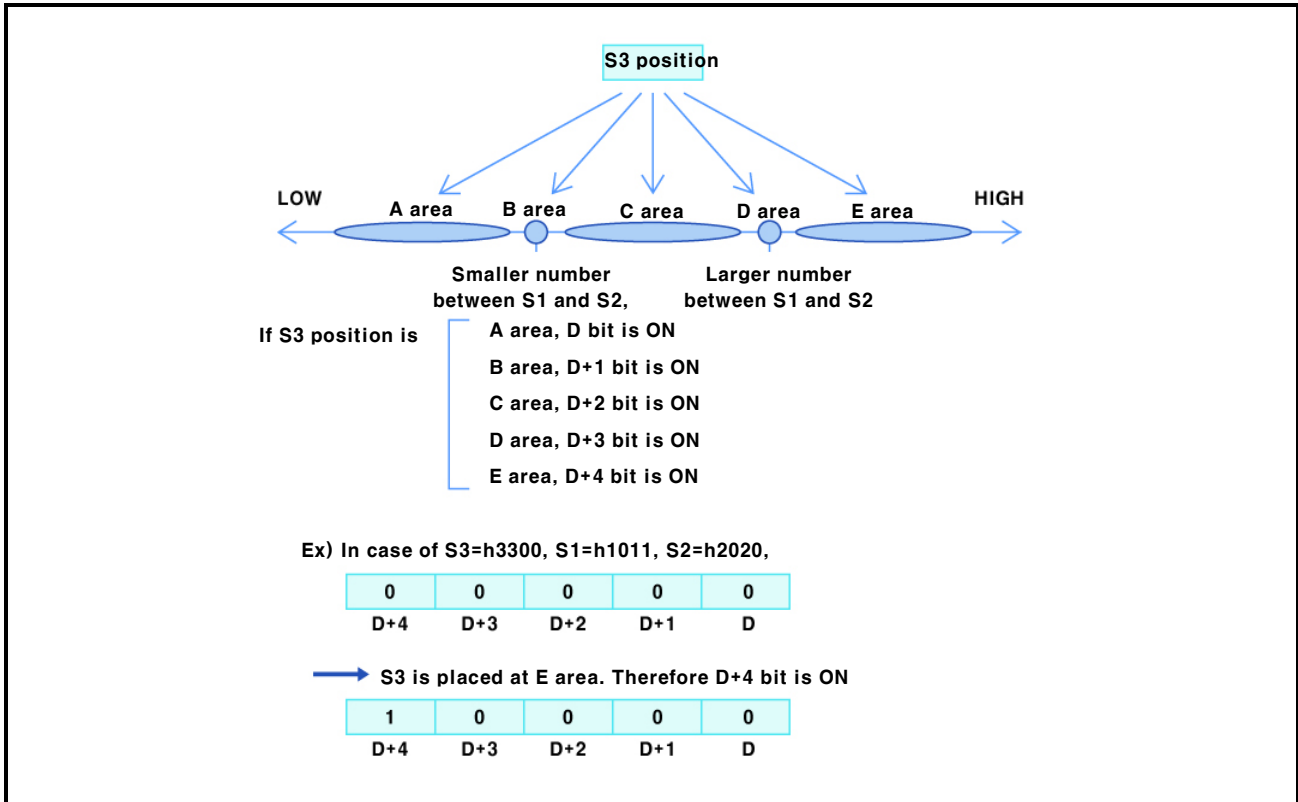

### 3.2.74 Comparison instruction(DBWCMP)

Comparison instruction		DBWCMP	S1	S2	S3	D	Applicable model LP-S044, LP-S070				
OP	DATA type	Available device / Description / Range					Error	Zero	Carry	Borrow	Step
S1	DINT	X, Y, M, S, T, C, D, Z, F, UW, integer									9
		Data to compare with S2 and S3									
		-2147483648(h80000000) to 2147483647(h7FFFFFFF)									
S2	DINT	X, Y, M, S, T, C, D, Z, F, UW, integer									
		Data to compare with S1 and S3									
		-2147483648(h80000000) to 2147483647(h7FFFFFFF)									
S3	DINT	X, Y, M, S, T, C, D, Z, F, UW, integer									
		Data to compare with S1 and S2									
		-2147483648(h80000000) to 2147483647(h7FFFFFFF)									
D	BIT	Y, M, UB									
		Bit device address to save comparison result									
		Not applicable									

<Ladder>

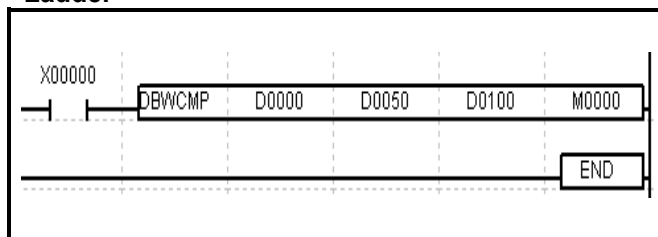

Compares the double word value of S3 with the limited area between S1 and S2 word values.

As a result :

1. If the value of S3 is less than the smaller value of the two(S1, S2), D bit turns ON.
2. If the value of S3 is equal to the smaller value of the two, D+1 bit turns ON.
3. If the value of S3 is located between the two values, D+2 bit turns ON.
4. If the value of S3 is equal to the larger value of the two, D+3 bit turns ON.
5. If the value of S3 is greater than the larger value of the two, D+4 bit turns ON.
6. Comparison executes the Signed operation.

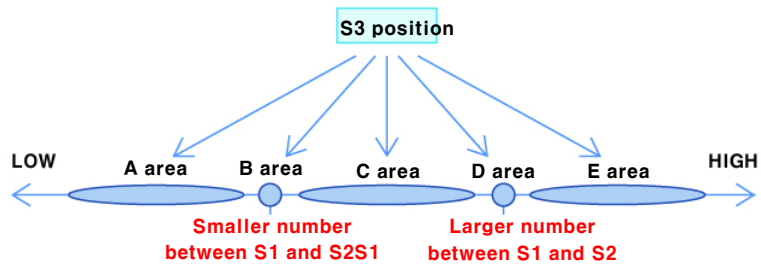

- If S3 position is
- A area, D bit is ON
  - B area, D+1 bit is ON
  - C area, D+2 bit is ON
  - D area, D+3 bit is ON
  - E area, D+4 bit is ON

Ex) In case of S3=h33003300, S1=h10000111, S2=h2020FF00,

0	0	0	0	0
D+4	D+3	D+2	D+1	D

→ S3 is placed at E area. Therefore D+4 bit is ON

1	0	0	0	0
D+4	D+3	D+2	D+1	D

### 3.2.75 Transmission instruction(BMOV)

Transmission instruction			<b>BMOV</b>	<b>S</b>	<b>D</b>	Applicable model LP-S044, LP-S070				
OP	DATA type	Available device / Description / Range				Error	Zero	Carry	Borrow	Step
<b>S</b>	BIT	X, Y, F, T, C, M, UB								5
		Bit device number you want to transmit								
		Not applicable								
<b>D</b>	BIT	Y, F, T, C, M, UB								
		Bit device address to save the transmitted data								
		Not applicable								

<Ladder>

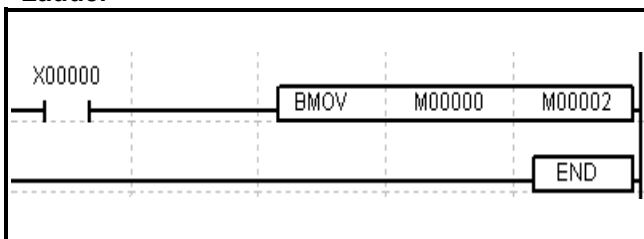

Transmits the source bit to the destination bit.

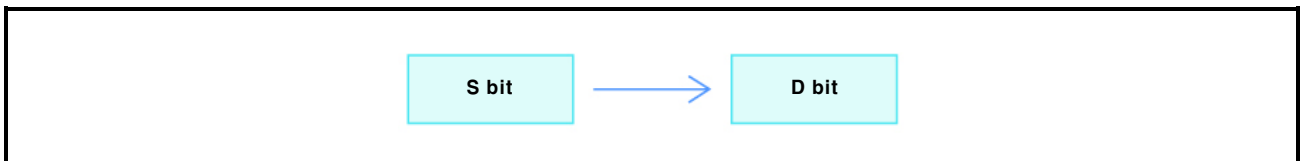

### 3.2.76 Transmission instruction(MOV)

<b>Transmission instruction</b>		<b>MOV</b>	<b>S</b>	<b>D</b>	Applicable model LP-S044, LP-S070				
OP	DATA type	Available device / Description / Range			Error	Zero	Carry	Borrow	Step
<b>S</b>	WORD	X, Y, F, Z, T, C, M, S, L, D, UW, integer							5
		Data to transmit or device number which have the data							
		0(h0000) to 65535(hFFFF)							
<b>D</b>	WORD	Y, F, Z, T, C, M, S, L, D, UW							
		Device number to save transmitted data							
		0(h0000) to 65535(hFFFF)							

<Ladder>

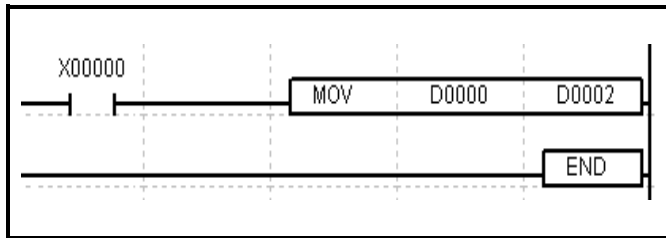

Transmits the source word to the destination word.

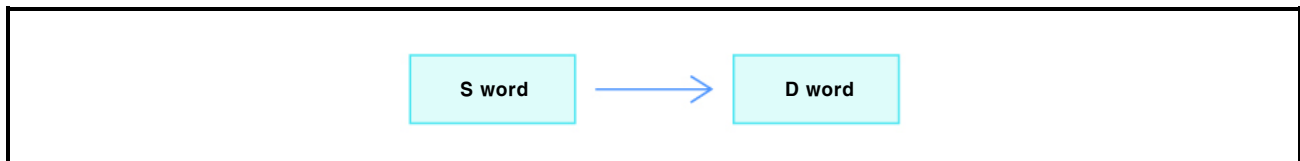

### 3.2.77 Transmission instruction(DMOV)

<b>Transmission instruction</b> <b>DMOV</b> <b>S</b> <b>D</b>			Applicable model LP-S044, LP-S070				
OP	DATA type	Available device / Description / Range	Error	Zero	Carry	Borrow	Step
<b>S</b>	DWORD	X, Y, F, Z, T, C, M, S, L, D, UW, integer					
		Data to transmit or device number which have the data					
		0(h0000) to 4294967295(hFFFFFFF)					5
<b>D</b>	DWORD	Y, F, Z, T, C, M, S, L, D, UW					
		Device number to save transmitted data					
		0(h0000) to 4294967295(hFFFFFFF)					

<Ladder>

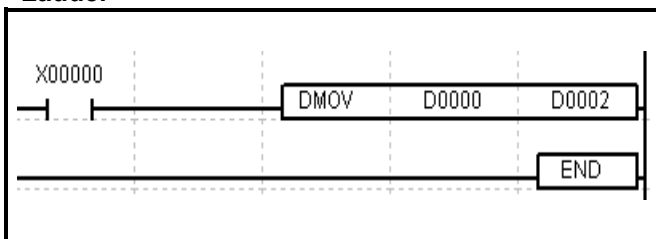

Transmits the source double word to the destination double word.

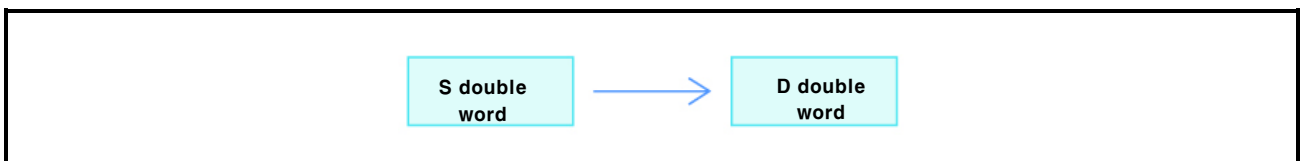

### 3.2.78 Transmission instruction(BMOVL)

Transmission instruction		BMOVL	S	D	N	Applicable model LP-S044, LP-S070				
OP	DATA type	Available device / Description / Range				Error	Zero	Carry	Borrow	Step
S	BIT	X, Y, F, T, C, M, UB								7
		Bit device number you want to transmit								
		Not applicable								
D	BIT	Y, F, T, C, M, UB								
		Bit device address to save the transmitted data								
		Not applicable								
N	WORD	X, Y, F, Z, T, C, M, S, L, D, UW, integer								
		The number of destination bit devices to save the transmitted data								
		To the remained devices in corresponding D area								

<Ladder>

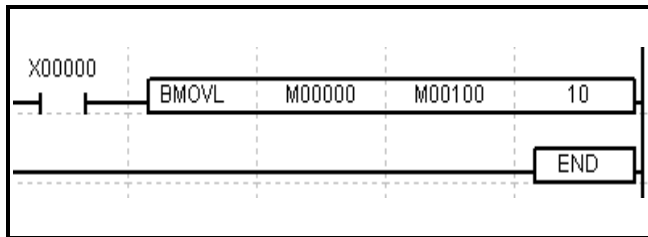

Transmits the source bit to the number of N bits beginning with D, one by one.

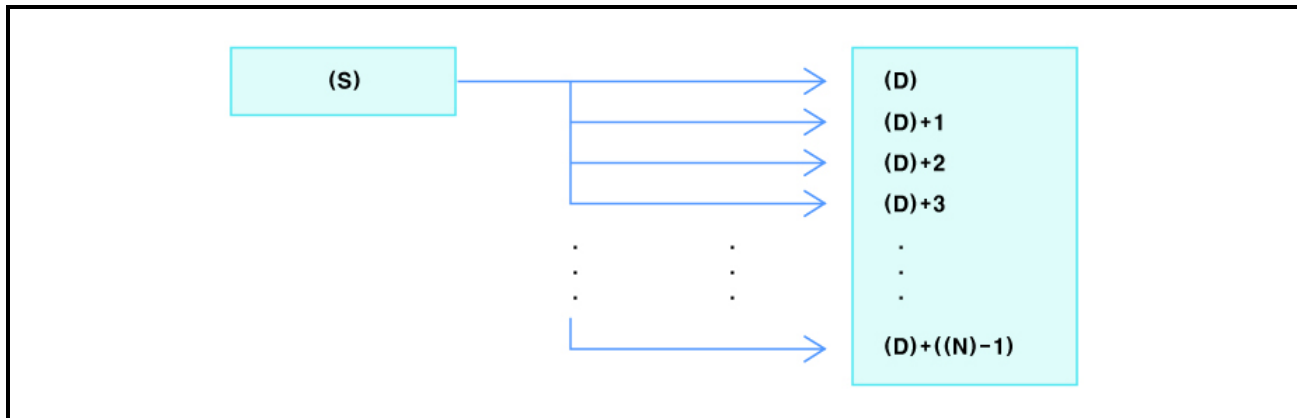



### 3.2.79 Transmission instruction(MOVL)

Transmission instruction			MOVL	S	D	N	Applicable model				
							LP-S044, LP-S070				
OP	DATA type	Available device / Description / Range					Error	Zero	Carry	Borrow	Step
S	WORD	X, Y, F, Z, T, C, M, S, L, D, UW, integer									7
		Data to transmit or device number which have the data									
		0(h0000) to 65535(hFFFF)									
D	WORD	Y, F, Z, T, C, M, S, L, D, UW									
		Device number to save transmitted data									
		0(h0000) to 65535(hFFFF)									
N	WORD	X, Y, F, Z, T, C, M, S, L, D, UW, integer									
		The number of destination bit devices to save the transmitted data									
		To the remained devices in corresponding D area									

<Ladder>

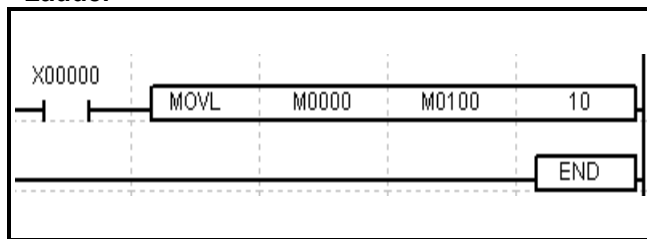

Transmits the source word to the number of N words beginning with D, one by one.

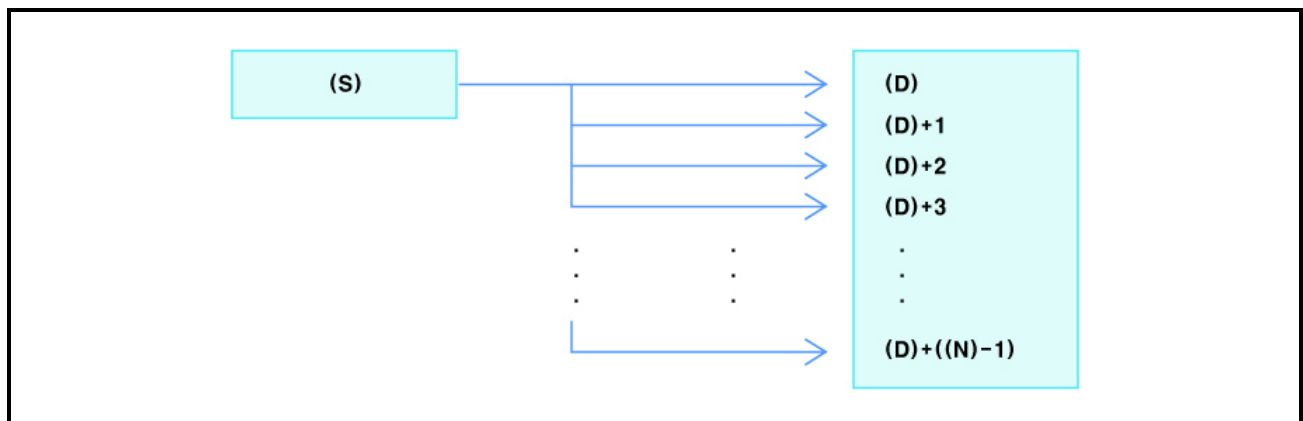

### 3.2.80 Transmission instruction(DMOVL)

Transmission instruction		DMOVL	S	D	N	Applicable model LP-S044, LP-S070				
OP	DATA type	Available device / Description / Range				Error	Zero	Carry	Borrow	Step
S	DWORD	X, Y, F, Z, T, C, M, S, L, D, UW, integer								7
		Data to transmit or device number which have the data								
		0(h0000) to 4294967295(hFFFFFFFF)								
D	DWORD	Y, F, Z, T, C, M, S, L, D, UW								
		Device number to save transmitted data								
		0(h0000) to 4294967295(hFFFFFFFF)								
N	WORD	X, Y, F, Z, T, C, M, S, L, D, UW, integer								
		The number of destination bit devices to save the transmitted data								
		To the remained devices in corresponding D area								

<Ladder>

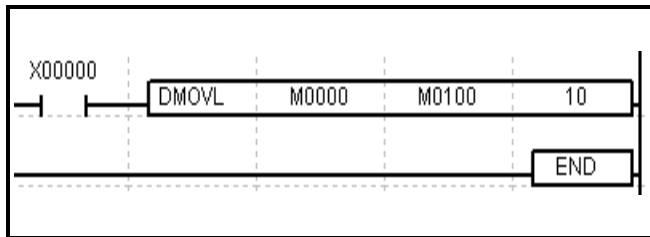

Transmit the source double word to the number of N double words beginning with D, one by one.

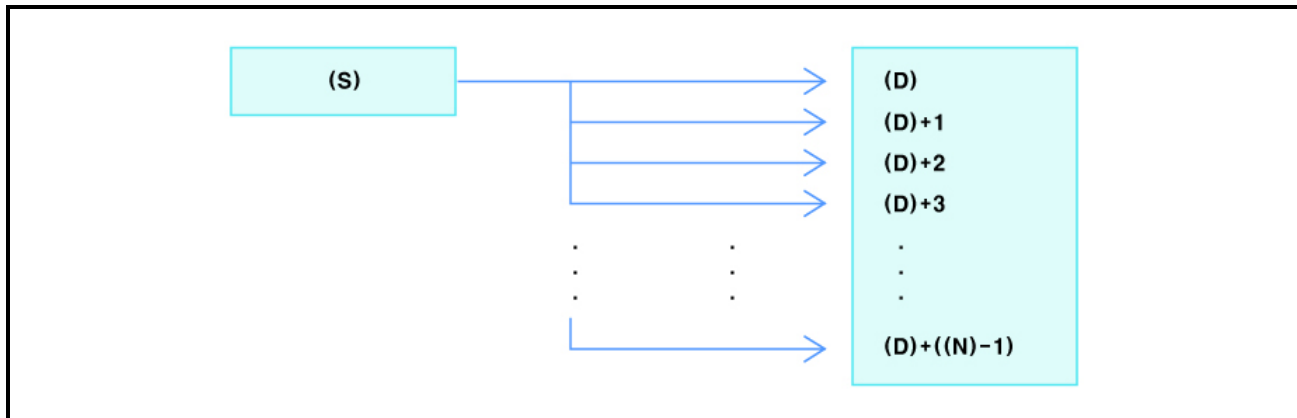

### 3.2.81 Transmission instruction(BMOVG)

Transmission instruction			BMOVG	S	D	N	Applicable model				
							LP-S044, LP-S070				
OP	DATA type	Available device / Description / Range					Error	Zero	Carry	Borrow	Step
S	BIT	X, Y, F, T, C, M, UB									7
		Bit device number you want to transmit									
		Not applicable									
D	BIT	Y, F, T, C, M, UB									
		Bit device address to save the transmitted data									
		Not applicable									
N	WORD	X, Y, F, Z, T, C, M, S, L, D, UW, integer									
		The number of bit devices to save to be transmitted data and the transmitted data									
		To the remained devices in corresponding S, D areas									

<Ladder>

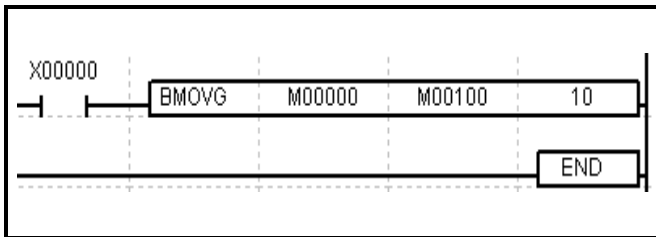

Transmits the number of N bit groups beginning with (S) to the number of N bit groups beginning with (D), in batches.

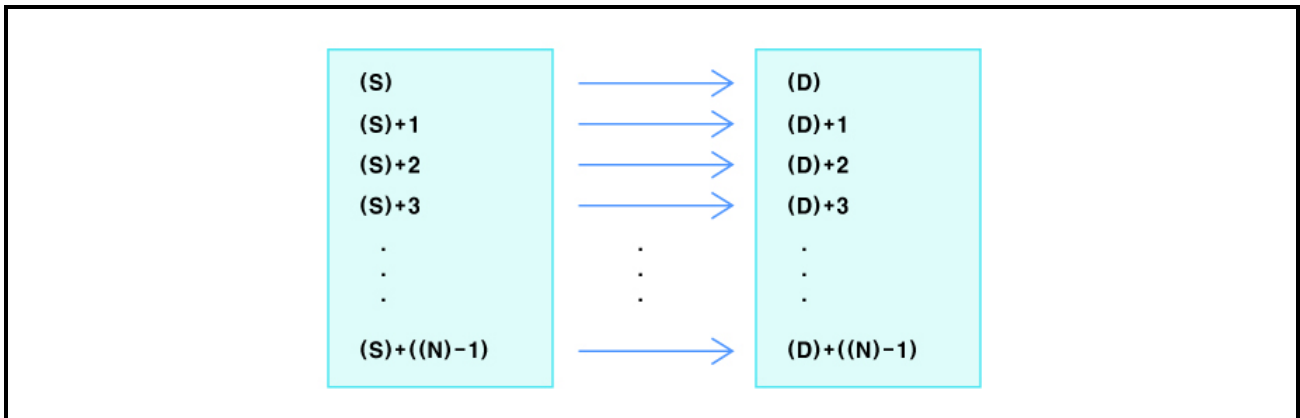

### 3.2.82 Transmission instruction(MOVG)

Transmission instruction		<b>MOVG</b>	<b>S</b>	<b>D</b>	<b>N</b>	Applicable model LP-S044, LP-S070				
OP	DATA type	Available device / Description / Range				Error	Zero	Carry	Borrow	Step
<b>S</b>	WORD	X, Y, F, Z, T, C, M, S, L, D, UW								7
		Data to transmit or device number which have the data								
		0(h0000) to 65535(hFFFF)								
<b>D</b>	WORD	Y, F, Z, T, C, M, S, L, D, UW								
		Device number to save transmitted data								
		0(h0000) to 65535(hFFFF)								
<b>N</b>	WORD	X, Y, F, Z, T, C, M, S, L, D, UW, integer								
		The number of bit devices to save to be transmitted data and the transmitted data								
		To the remained devices in corresponding S, D areas								

<Ladder>

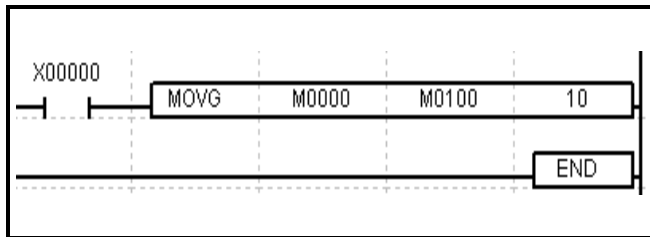

Transmit the number of N word groups beginning with (S), to the number of N word groups beginning with (D), in batches.

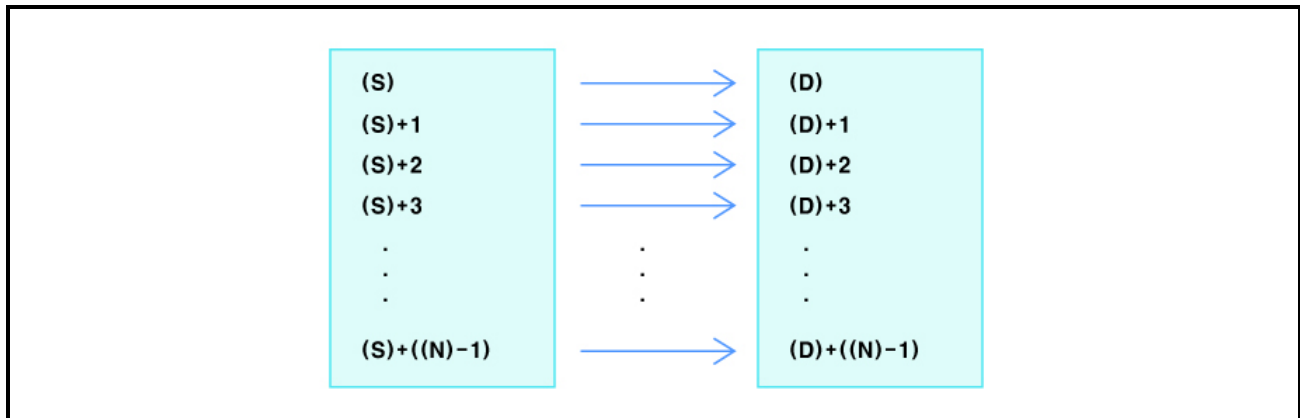

### 3.2.83 Transmission instruction(DMOVG)

Transmission instruction			DMOVG	S	D	N	Applicable model LP-S044, LP-S070				
OP	DATA type	Available device / Description / Range					Error	Zero	Carry	Borrow	Step
S	DWORD	X, Y, F, Z, T, C, M, S, L, D ,UW									7
		Data to transmit or device number which have the data									
		0(h0000) to 4294967295(hFFFFFFF)									
D	DWORD	Y, F, Z, T, C, M, S, L, D ,UW									
		Device number to save transmitted data									
		0(h0000) to 4294967295(hFFFFFFF)									
N	WORD	X, Y, F, Z, T, C, M, S, L, D ,UW, integer									
		The number of bit devices to save to be transmitted data and the transmitted data									
		To the remained devices in corresponding S, D areas									

<Ladder>

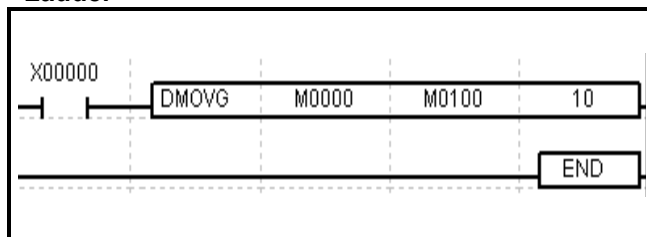

Transmit the number of N double word groups beginning with (S) to the number of N double word groups beginning with (D), in batches.

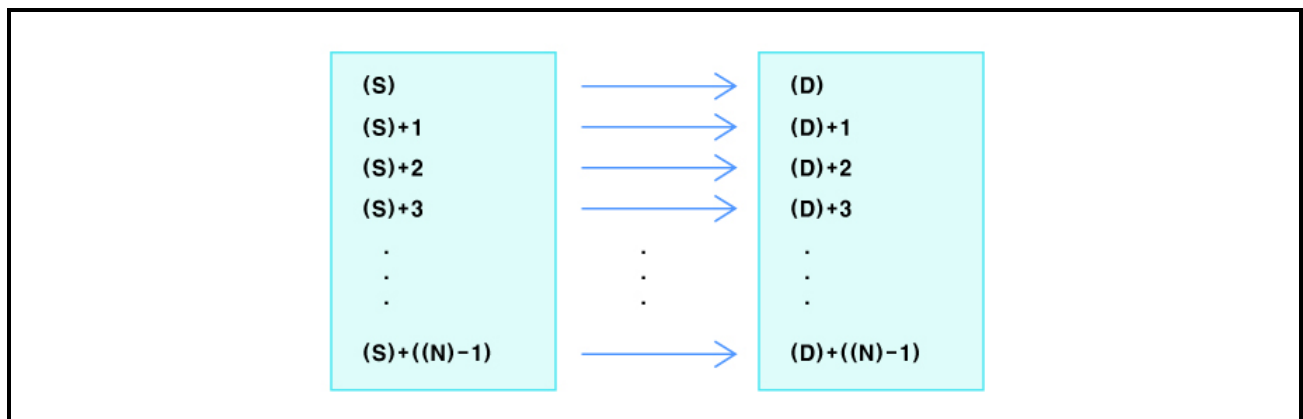

### 3.2.84 Transmission instruction(BCMOV)

<b>Transmission instruction</b>		<b>BCMOV</b>	<b>S</b>	<b>D</b>	Applicable model LP-S044, LP-S070				
OP	DATA type	Available device / Description / Range			Error	Zero	Carry	Borrow	Step
<b>S</b>	BIT	X, Y, F, T, C, M, UB							5
		Bit device number you want to transmit							
		Not applicable							
<b>D</b>	BIT	Y, F, T, C, M, UB							
		Bit device address to save the transmitted data							
		Not applicable							

<Ladder>

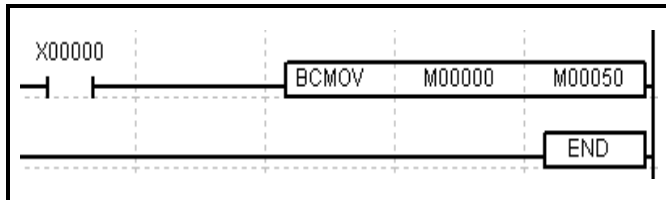

Reverses the source device and then transmits it to the destination bit.

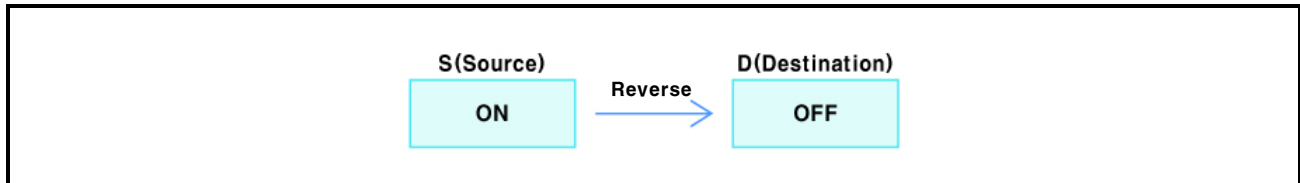

### 3.2.85 Transmission instruction(CMOV)

Transmission instruction			<b>CMOV</b>	<b>S</b>	<b>D</b>	Applicable model LP-S044, LP-S070				
OP	DATA type	Available device / Description / Range				Error	Zero	Carry	Borrow	Step
<b>S</b>	WORD	X, Y, F, Z, T, C, M, S, L, D, UW, integer								5
		Data to transmit or device number which have the data								
		0(h0000) to 65535(hFFFF)								
<b>D</b>	WORD	Y, F, Z, T, C, M, S, L, D, UW								
		Device number to save transmitted data								
		0(h0000) to 65535(hFFFF)								

<Ladder>

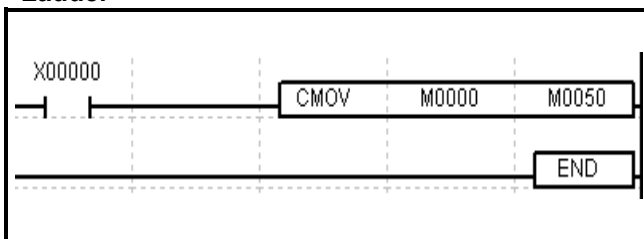

Reverses the source word and then transmits it to the destination word.

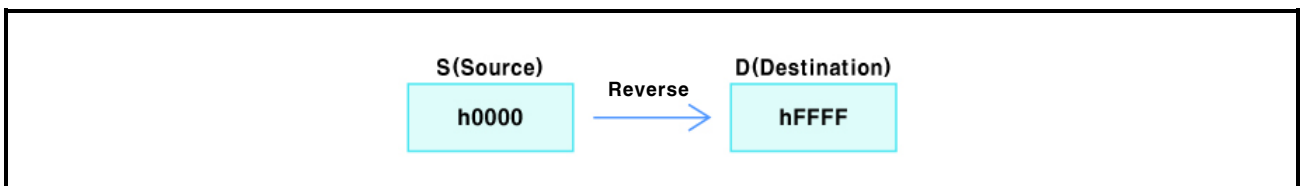

### 3.2.86 Transmission instruction(DCMOV)

<b>Transmission instruction</b>		<b>DCMOV</b>	<b>S</b>	<b>D</b>	Applicable model LP-S044, LP-S070				
OP	DATA type	Available device / Description / Range			Error	Zero	Carry	Borrow	Step
<b>S</b>	DWORD	X, Y, F, Z, T, C, M, S, L, D, UW, integer							5
		Data to transmit or device number which have the data							
		0(h0000) to 4294967295(hFFFFFFFF)							
<b>D</b>	DWORD	Y, F, Z, T, C, M, S, L, D, UW							
		Device number to save transmitted data							
		0(h0000) to 4294967295(hFFFFFFFF)							

<Ladder>

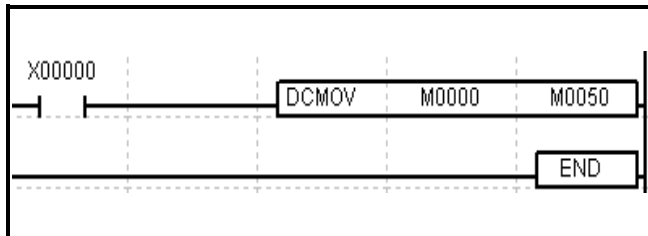

Reverses the source double word and then transmits it to the destination double word.

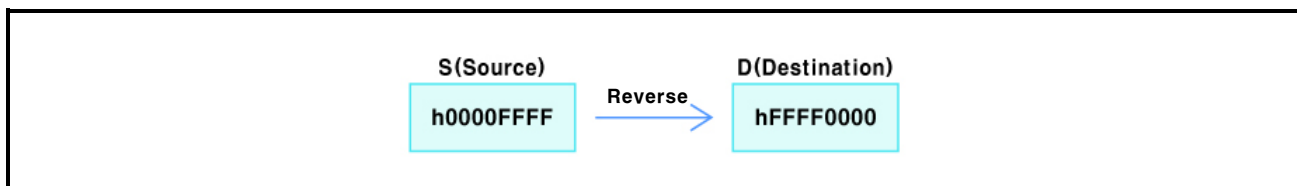



### 3.2.87 Exchange instruction(XCH)

Exchange instruction		XCH	S1	S2	Applicable model				
					LP-S044, LP-S070				
OP	DATA type	Available device / Description / Range			Error	Zero	Carry	Borrow	Step
S1	WORD	Y, F, Z, T, C, M, S, L, D, UW							5
		Data device number to be exchanged							
		0(h0000) to 65535(hFFFF)							
S2	WORD	Y, F, Z, T, C, M, S, L, D, UW							
		Data device number to be exchanged							
		0(h0000) to 65535(hFFFF)							

<Ladder>

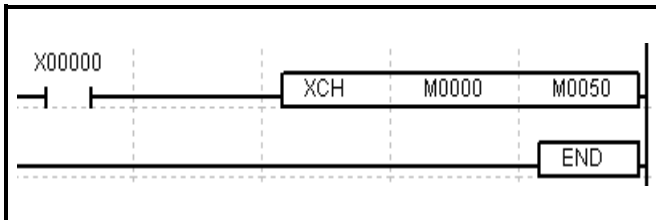

Exchanges a data in S1 word and a data in S2 word each other.

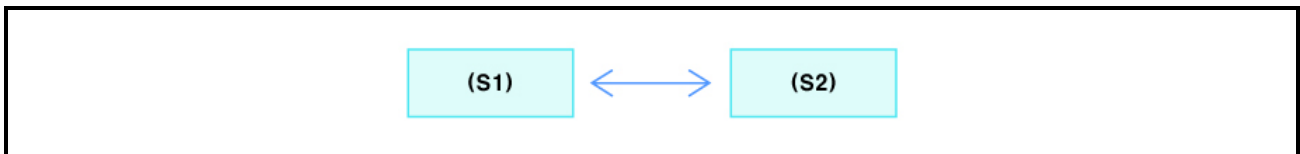

### 3.2.88 Exchange instruction(DXCH)

<b>Exchange instruction</b>		<b>DXCH</b>	<b>S1</b>	<b>S2</b>	Applicable model LP-S044, LP-S070				
OP	DATA type	Available device / Description / Range			Error	Zero	Carry	Borrow	Step
<b>S1</b>	DWORD	Y, F, Z, T, C, M, S, L, D, UW							5
		Data device number to be exchanged							
		0(h0000) to 4294967295(hFFFFFFF)							
<b>S2</b>	DWORD	Y, F, Z, T, C, M, S, L, D, UW							
		Data device number to be exchanged							
		0(h0000) to 4294967295(hFFFFFFF)							

<Ladder>

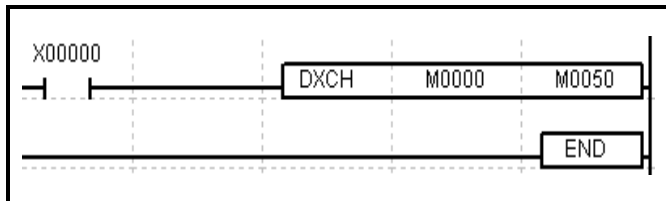

Exchanges a data in the double word S1 and a data in the double word S2 each other.

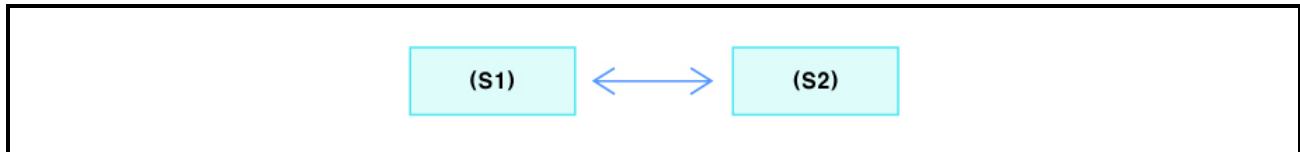

### 3.2.89 Exchange instruction (AXCH)

Exchange instruction	AXCH	S1	S2	N	Applicable model
					LP-S044, LP-S070
OP	DATA type	Available device / Description / Range			
S1	BIT	Y, F, T, C, M, UB			Error
		Bit device address of the data to be exchanged			Zero
		Not applicable			Carry
S2	BIT	Y, F, T, C, M, UB			Borrow
		Bit device address of the data to be exchanged			Step
		Not applicable			7
N	WORD	Y, F, Z, T, C, M, S, L, D, UW, integer			
		The number of the data bits to be exchanged			
		To the device range remained in corresponding S1 and S2 areas.			

<Ladder>

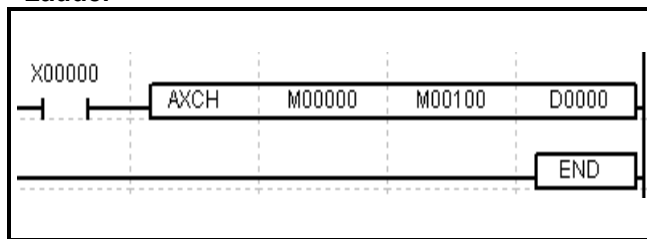

Exchanges the number of N bits beginning with S1 with the number of N bits beginning from S2 each other.

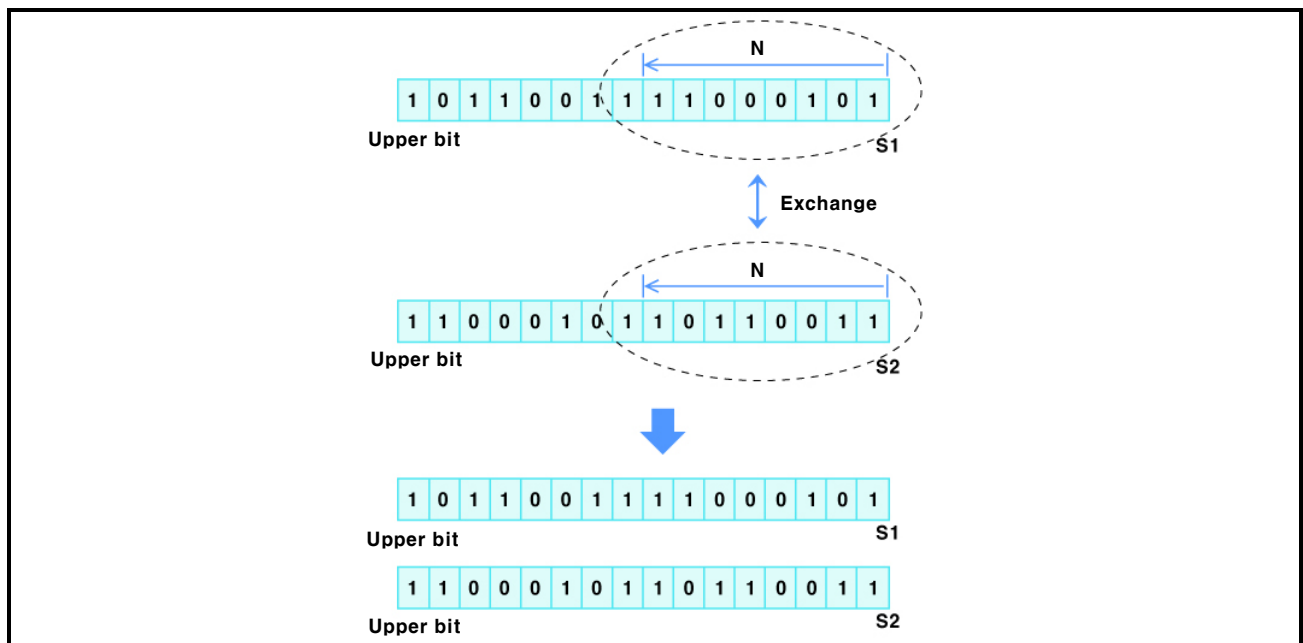

### 3.2.90 Exchange instruction(SWAP)

Exchange instruction		SWAP	D	Applicable model LP-S044, LP-S070					
OP	DATA type	Available device / Description / Range			Error	Zero	Carry	Borrow	Step
D	WORD	Y, F, Z, T, C, M, S, L, D, UW							3
		Data address to exchange upper and lower bit							
		0(h0000) to 65535(hFFFF)							

<Ladder>

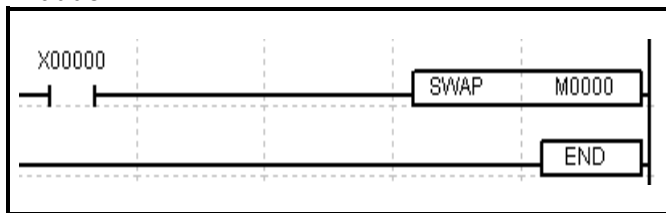

Exchanges the high order bytes of the designated word with its low order bytes each other.

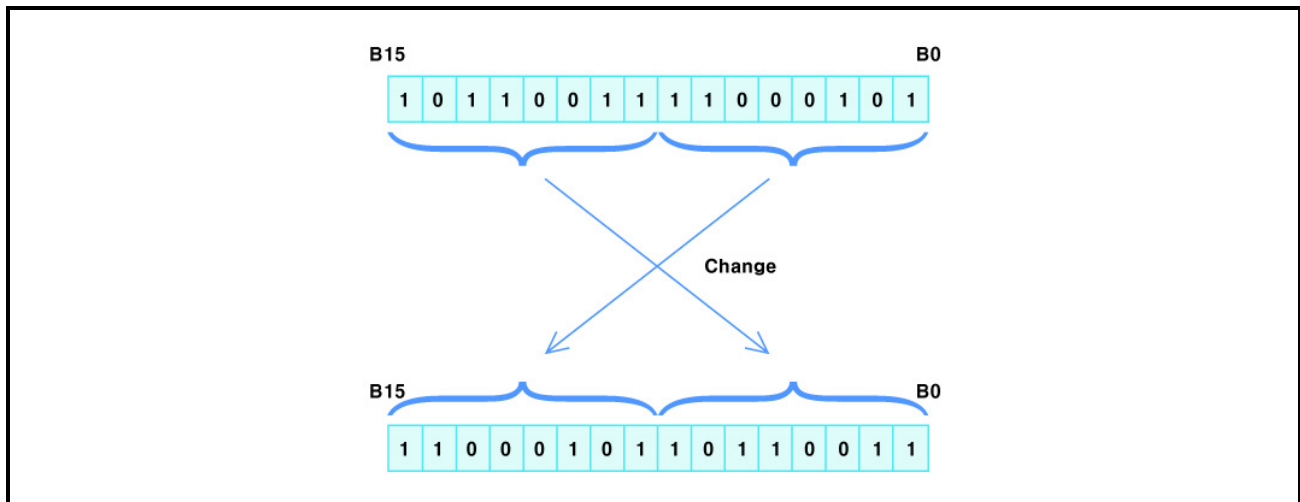

### 3.2.91 Exchange instruction(DSWAP)

Exchange instruction			DSWAP	D	Applicable model LP-S044, LP-S070				
OP	DATA type	Available device / Description / Range			Error	Zero	Carry	Borrow	Step
D	DWORD	Y, F, Z, T, C, M, S, L, D, UW							
		Data address to exchange upper and lower bit							
		0(h0000) to 4294967295(hFFFFFFF)							3

<Ladder>

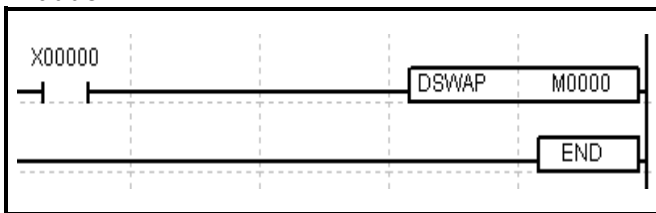

Exchanges the high order word of the designated double word with its low order word.

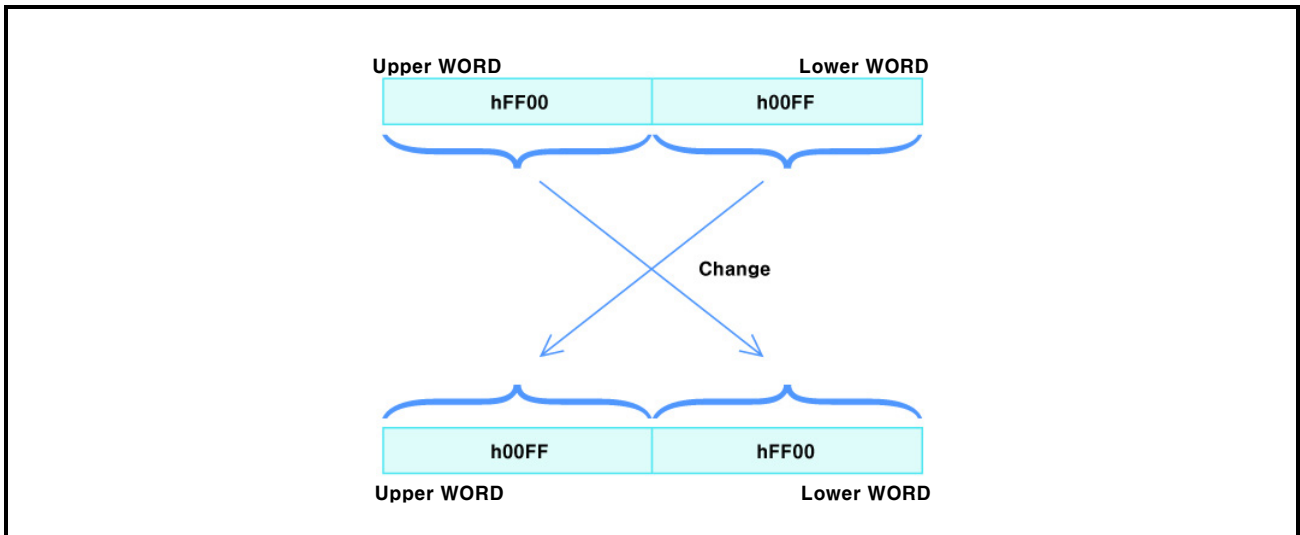

### 3.2.92 Rotation instruction(ROR)

Rotation instruction		ROR	S	C	Applicable model LP-S044, LP-S070				
OP	DATA type	Available device / Description / Range			Error	Zero	Carry	Borrow	Step
S	WORD	Y, F, Z, T, C, M, S, L, D, UW							5
		Data address to execute the operation							
		0(h0000) to 65535(hFFFF)							
C	WORD	X, Y, F, Z, T, C, M, S, L, D, UW, integer							
		The number of bits to rotate right side							
		0 to 255							

<Ladder>

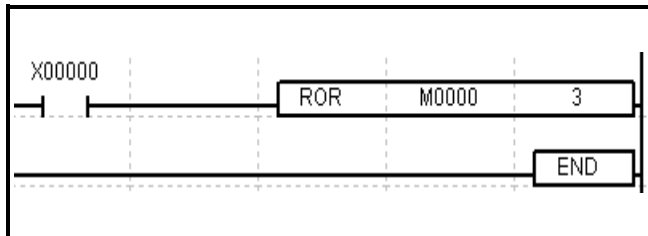

Rotates the source word to the right side by the number of C bits.

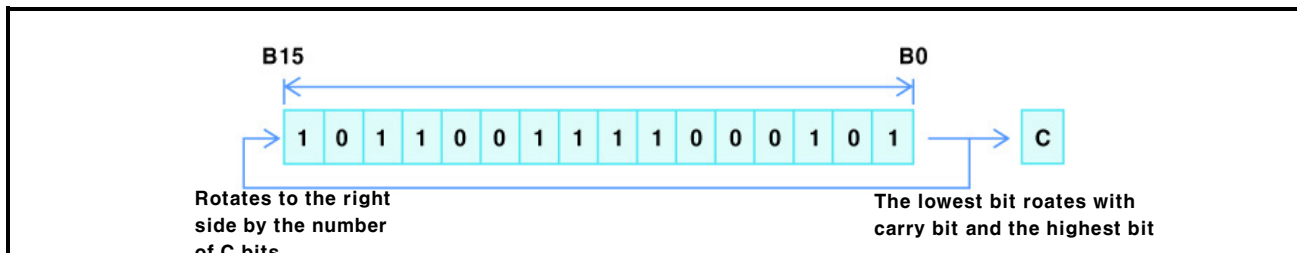

### 3.2.93 Rotation instruction(DROR)

Rotation instruction			DROR	S	C	Applicable model LP-S044, LP-S070				
OP	DATA type	Available device / Description / Range				Error	Zero	Carry	Borrow	Step
S	DWORD	X, F, Z, T, C, M, S, L, D, UW								5
		Data address to execute the operation								
		0(h0000) to 4294967295(hFFFFFFF)								
C	WORD	X, Y, F, Z, T, C, M, S, L, D, UW, integer								
		The number of bits to rotate right side								
		0 to 255								

<Ladder>

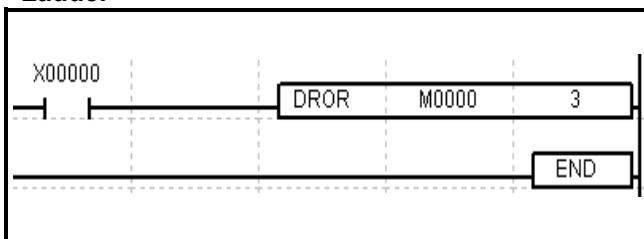

Rotates the source double word to the right side by the number of C bits.

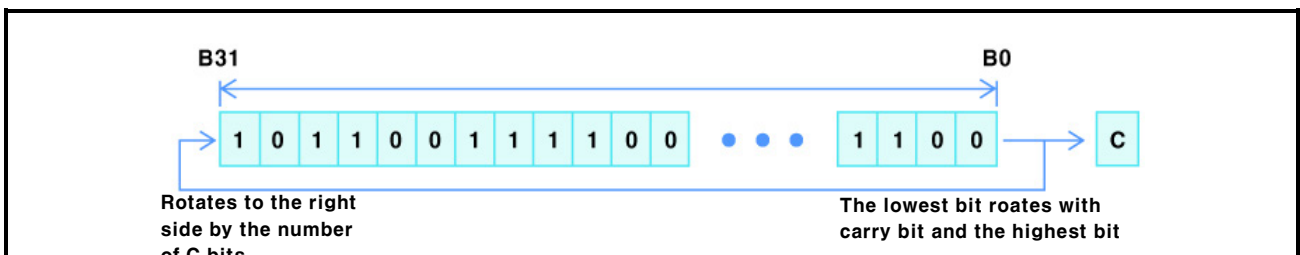

### 3.2.94 Rotation instruction(AROR)

Rotation instruction		AROR	S	N	C	Applicable model LP-S044, LP-S070					
OP	DATA type	Available device / Description / Range					Error	Zero	Carry	Borrow	Step
S	BIT	Y, F, T, C, M, UB							⊙		7
		Start address for bit device of the data to execute the operation									
		Not applicable									
N	WORD	X, Y, F, Z, T, C, M, S, L, D, UW, integer									
		The number of bit device to execute the operation from start address To the remained device range in corresponding S area									
C	WORD	X, Y, F, Z, T, C, M, S, L, D, UW, integer									
		The number of bits to rotate right side 0 to 255									

<Ladder>

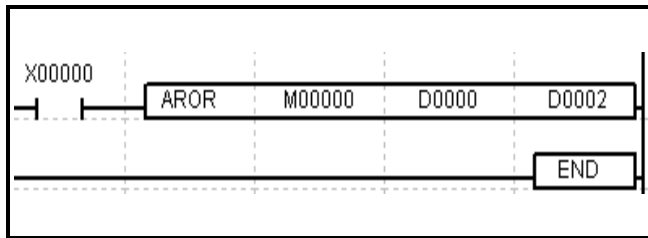

Within the number of N bits, bits rotate to the right side by the number of C bits beginning with S bit.

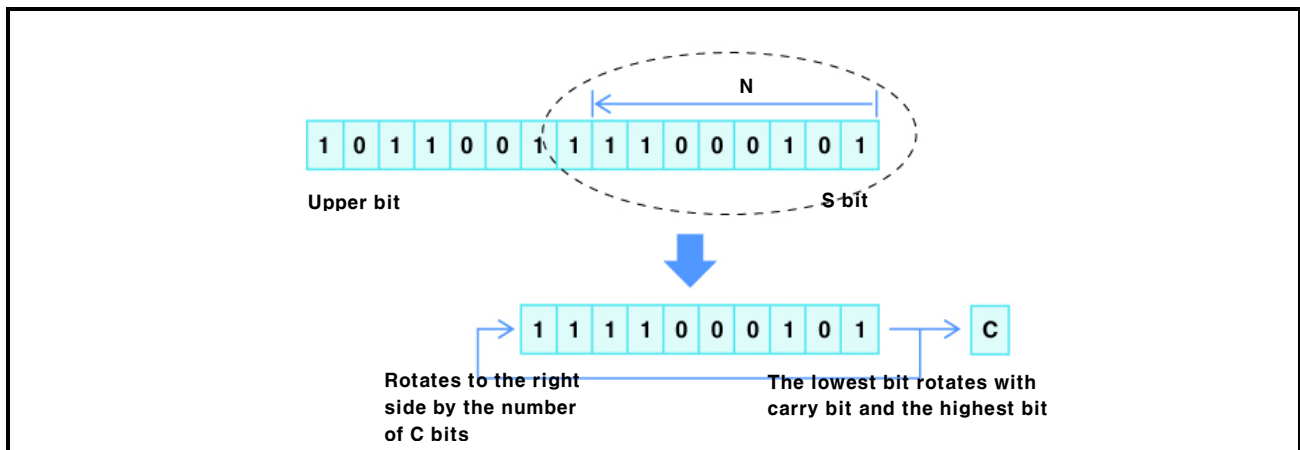



### 3.2.95 Rotation instruction(RORC)

Rotation instruction		RORC	S	C	Applicable model				
					LP-S044, LP-S070				
OP	DATA type	Available device / Description / Range			Error	Zero	Carry	Borrow	Step
S	WORD	Y, F, Z, T, C, M, S, L, D, UW					⊙		5
		Data address to execute the operation							
		0(h0000) to 65535(hFFFF)							
C	WORD	X, Y, F, Z, T, C, M, S, L, D, UW, integer							
		The number of bits to rotate right side							
		0 to 255							

<Ladder>

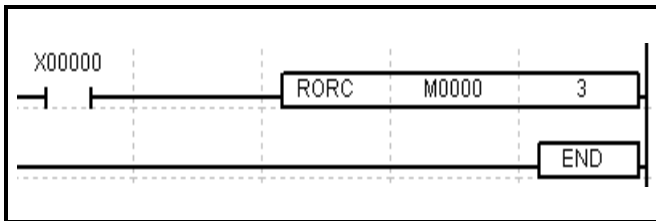

Rotates the source word including carry bit, to the right side by the number of C bits.

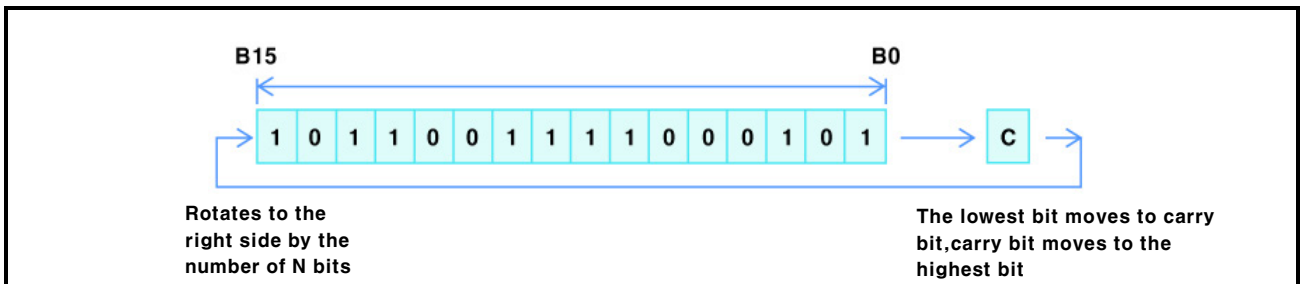

### 3.2.96 Rotation instruction(DRORC)

Rotation instruction		DRORC	S	C	Applicable model				
					LP-S044, LP-S070				
OP	DATA type	Available device / Description / Range			Error	Zero	Carry	Borrow	Step
S	DWORD	Y, F, Z, T, C, M, S, L, D, UW					⊙		5
		Data address to execute the operation							
		0(h0000) to 4294967295(hFFFFFFF)							
C	WORD	X, Y, F, Z, T, C, M, S, L, D, UW, integer							
		The number of bits to rotate right side							
		0 to 255							

<Ladder>

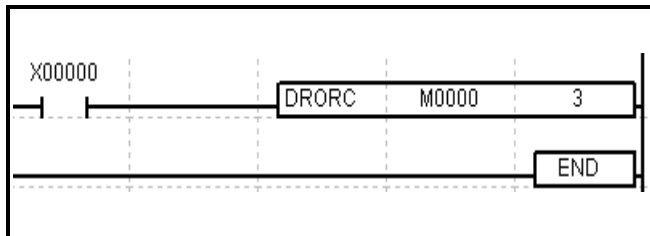

Rotates the source double word including carry bit, to the right side by the number of C bits.

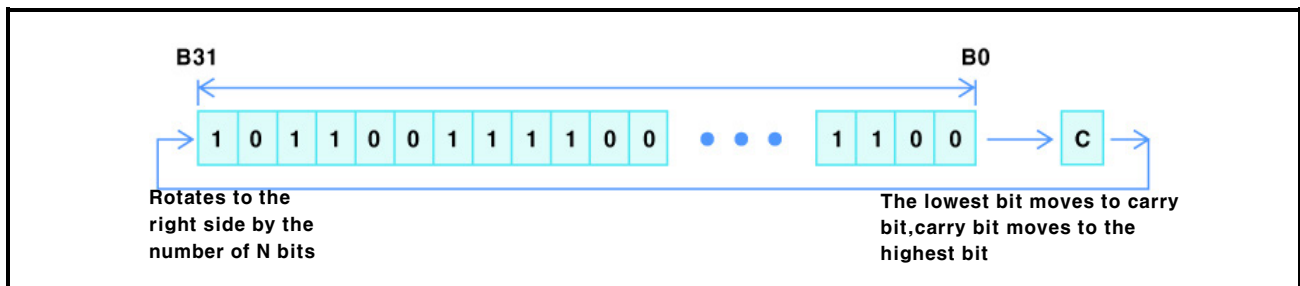

### 3.2.97 Rotation instruction(ARORC)

Rotation instruction	ARORC	S	N	C	Applicable model
					LP-S044, LP-S070
OP	DATA type	Available device / Description / Range			
S	BIT	Y, F, T, C, M, UB			Error
		Start address for bit device of the data to execute the operation			Zero
		Not applicable			Carry
N	WORD	X, Y, F, Z, T, C, M, S, L, D, UW, integer			Borrow
		The number of bit device to execute the operation from start address			Step
		To the remained device range in corresponding S area			7
C	WORD	X, Y, F, Z, T, C, M, S, L, D, UW, integer			
		The number of bits to rotate right side			
		0 to 255			

<Ladder>

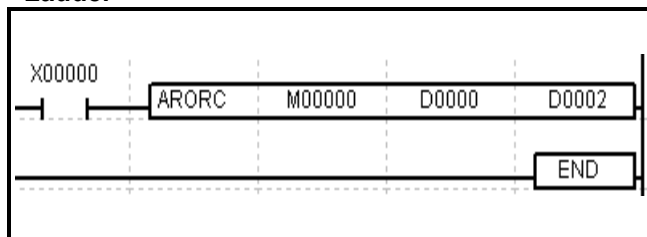

Within the number of N bits, rotates the designated bits including carry bit to the right side by the number of C bits.

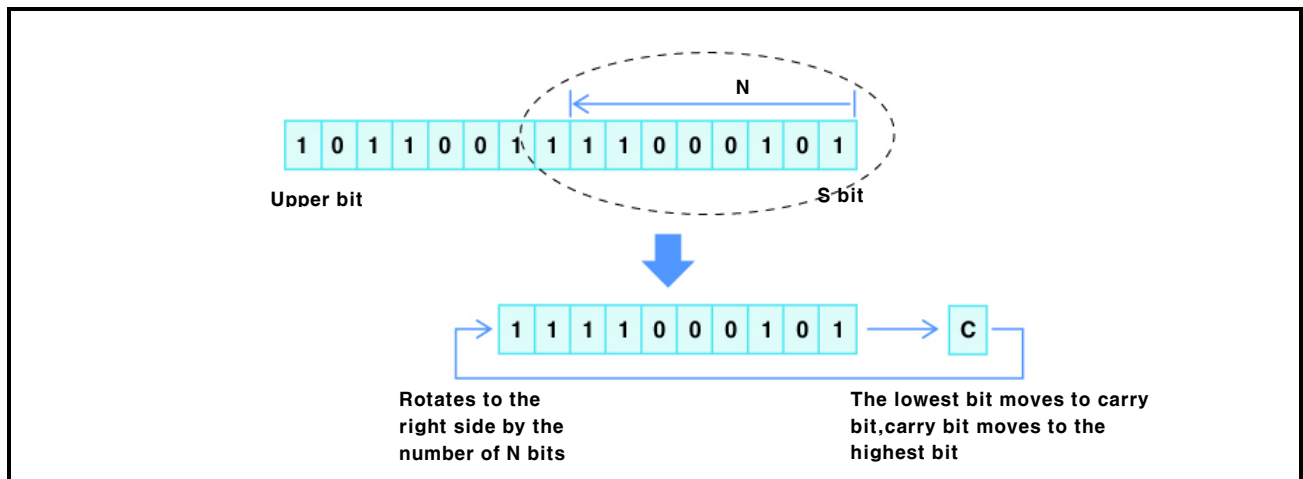

### 3.2.98 Rotation instruction(ROL)

Rotation instruction		ROL	S	C	Applicable model LP-S044, LP-S070				
OP	DATA type	Available device / Description / Range			Error	Zero	Carry	Borrow	Step
S	WORD	Y, F, Z, T, C, M, S, L, D, UW							5
		Data address to execute the operation							
		0(h0000) to 65535(hFFFF)							
C	WORD	X, Y, F, Z, T, C, M, S, L, D, UW, integer							
		The number of bits to rotate left side							
		0 to 255							

<Ladder>

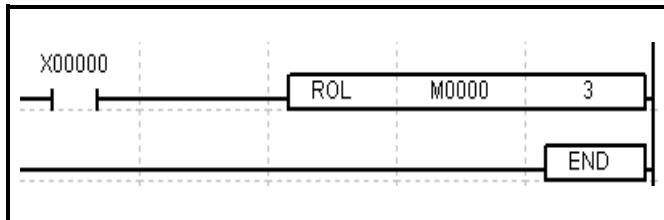

Rotates the source word to the left side by the number of C bits.

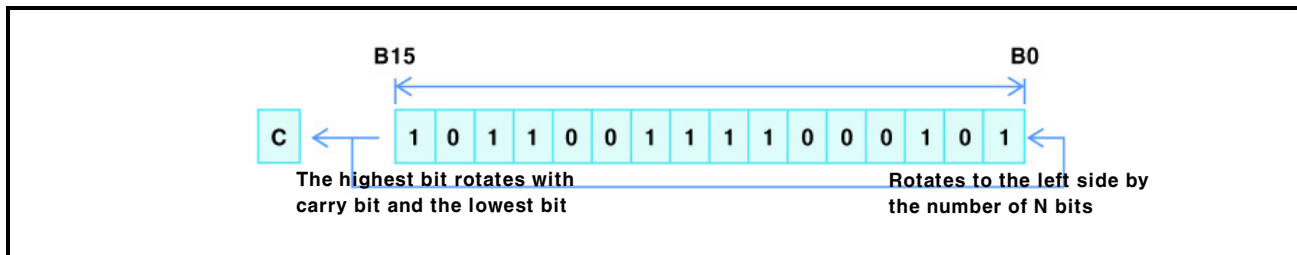

### 3.2.99 Rotation instruction(DROL)

Rotation instruction			DROL	S	C	Applicable model LP-S044, LP-S070				
OP	DATA type	Available device / Description / Range				Error	Zero	Carry	Borrow	Step
S	DWORD	Y, F, Z, T, C, M, S, L, D, UW								5
		Data address to execute the operation								
		0(h0000) to 4294967295(hFFFFFFF)								
C	WORD	X, Y, F, Z, T, C, M, S, L, D, UW, integer								
		The number of bits to rotate left side								
		0 to 255								

<Ladder>

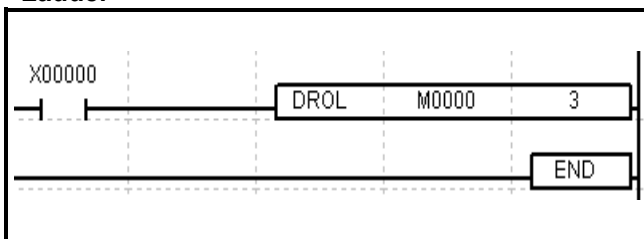

Rotates the source double word to the left side by the number of C bits.

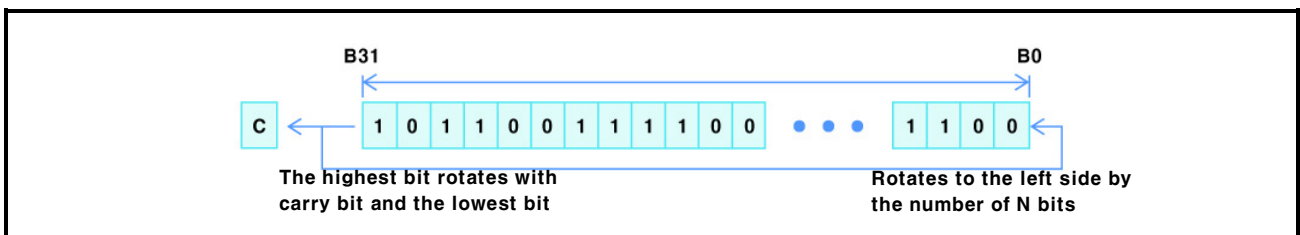

### 3.2.100 Rotation instruction(AROL)

Rotation instruction		AROL	S	N	C	Applicable model				
						LP-S044, LP-S070				
OP	DATA type	Available device / Description / Range				Error	Zero	Carry	Borrow	Step
S	BIT	Y, F, T, C, M, UB						⊙		7
		Start address for bit device of the data to execute the operation								
		Not applicable								
N	WORD	X, Y, F, Z, T, C, M, S, L, D, UW, integer								
		The number of bit device to execute the operation from start address								
		To the remained device range in corresponding S area								
C	WORD	X, Y, F, Z, T, C, M, S, L, D, UW, integer								
		The number of bits to rotate left side								
		0 to 255								

<Ladder>

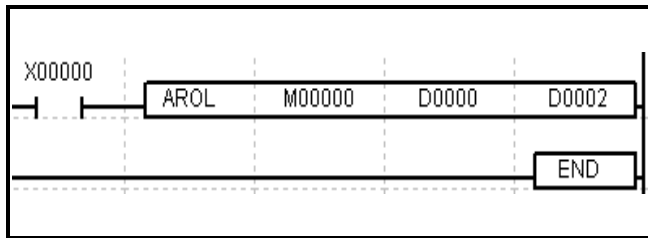

Within the number of N bits, rotates the designated bits beginning with the S bit to the left side by the number of C bits.

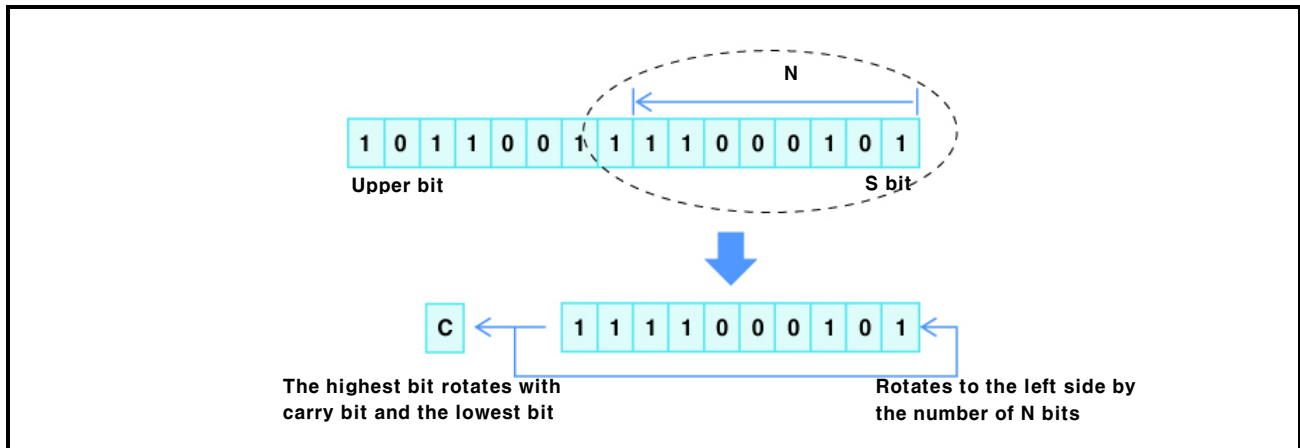

3.2.101 Rotation instruction(ROLC)

Rotation instruction <b>ROLC</b> <b>S</b> <b>C</b>			Applicable model LP-S044, LP-S070				
OP	DATA type	Available device / Description / Range	Error	Zero	Carry	Borrow	Step
<b>S</b>	WORD	Y, F, Z, T, C, M, S, L, D, UW					
		Data address to execute the operation					
		0(h0000) to 65535(hFFFF)			⊙		5
<b>C</b>	WORD	X, Y, F, Z, T, C, M, S, L, D, UW, integer					
		The number of bits to rotate right side					
		0 to 255					

<Ladder>

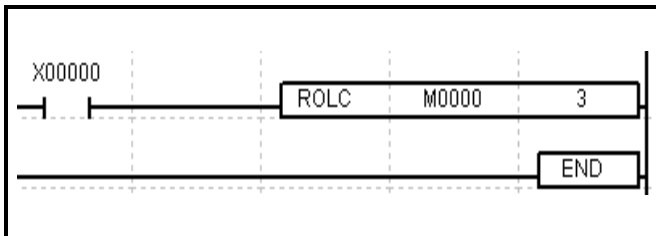

Rotates the source word including carry bit to the left side by the number of C bits.

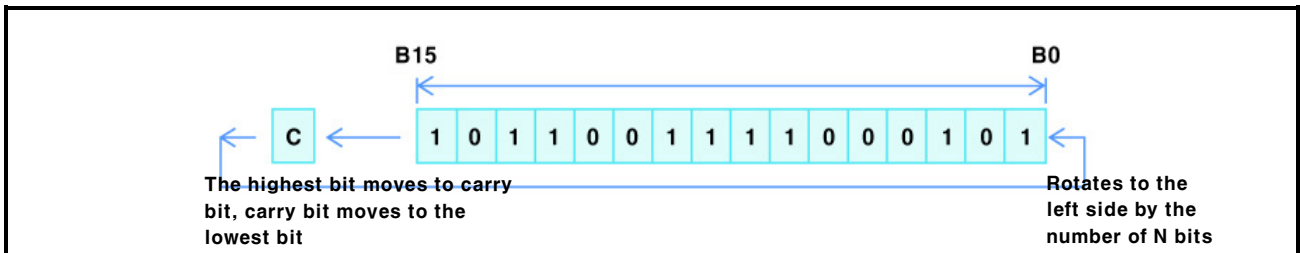

### 3.2.102 Rotation instruction(DROLCL)

Rotation instruction		DROLCL	S	C	Applicable model				
					LP-S044, LP-S070				
OP	DATA type	Available device / Description / Range			Error	Zero	Carry	Borrow	Step
S	DWORD	Y, F, Z, T, C, M, S, L, D, UW					⊙		5
		Data address to execute the operation							
		0(h0000) to 4294967295(hFFFFFFF)							
C	WORD	X, Y, F, Z, T, C, M, S, L, D, UW, integer							
		The number of bits to rotate left side							
		0 to 255							

<Ladder>

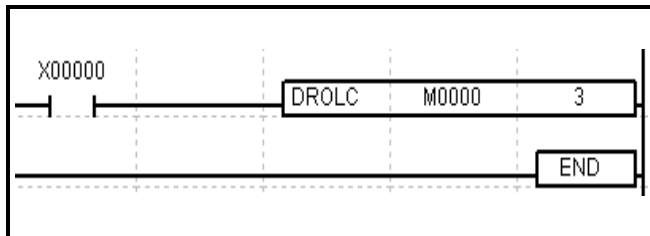

Rotates the source double word including the carry bit to the left side by the number of C bits.

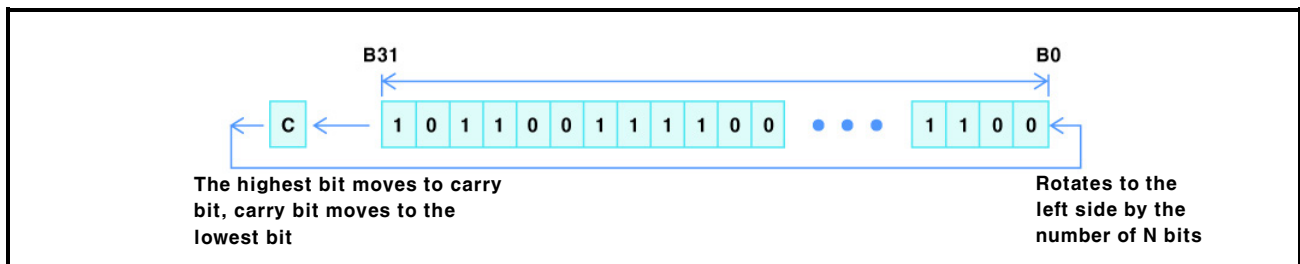



### 3.2.103 Rotation instruction(AROLC)

Rotation instruction		AROLC	S	N	C	Applicable model LP-S044, LP-S070					
OP	DATA type	Available device / Description / Range					Error	Zero	Carry	Borrow	Step
S	BIT	Y, F, T, C, M, UB							⊙		7
		Start address for bit device of the data to execute the operation									
		Not applicable									
N	WORD	X, Y, F, Z, T, C, M, S, L, D, UW, integer									
		The number of bit device to execute the operation from start address To the remained device range in corresponding S area									
C	WORD	X, Y, F, Z, T, C, M, S, L, D, UW, integer									
		The number of bits to rotate left side 0 to 255									

<Ladder>

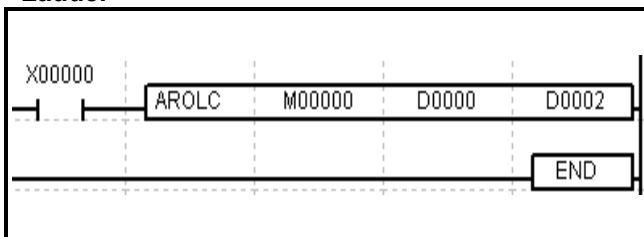

Within the range from the source bit to the N bit, rotates the designated bits including the carry bit to the left side by the number of C bits beginning with the S bit.

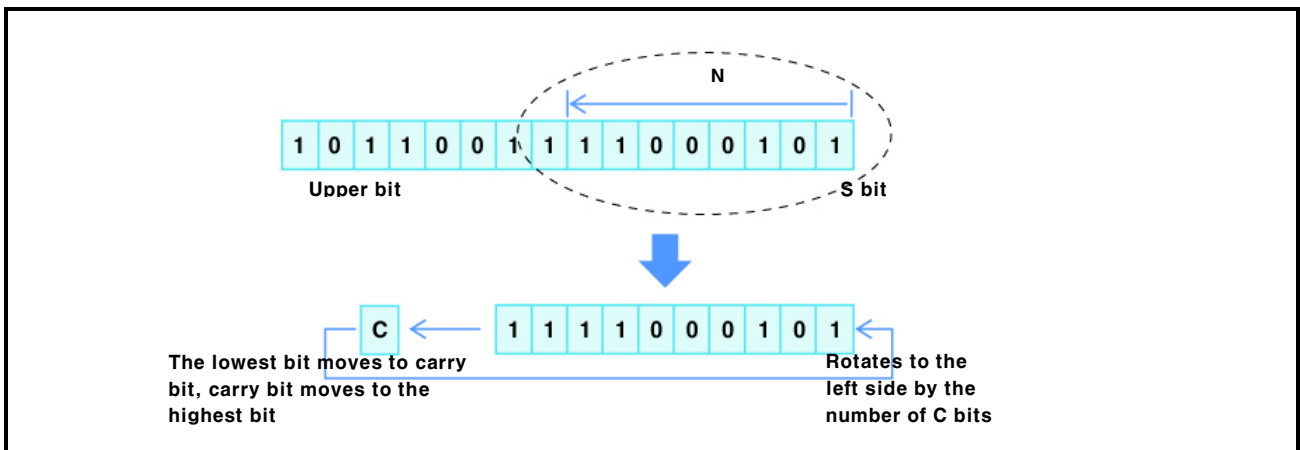

### 3.2.104 Movement instruction(SFTR)

Movement instruction		SFTR	S	N	Applicable model				
OP	DATA type	Available device / Description / Range			Error	Zero	Carry	Borrow	Step
S	WORD	Y, F, Z, T, C, M, S, L, D, UW					⊙		9
		Data address to execute the operation							
		0(h0000) to 65535(hFFFF)							
N	WORD	X, Y, F, Z, T, C, M, S, L, D, UW, integer							
		The number of bits to rotate right side							
		0 to 16							

<Ladder>

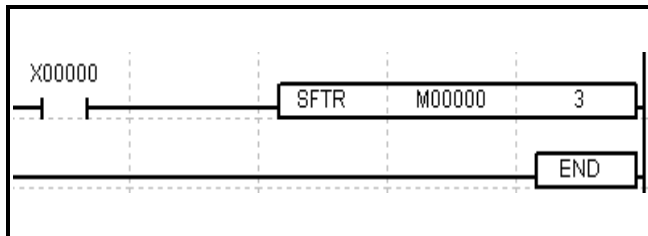

1. Within the S word, moves the 16-bit of S word to the right side by the number of N bits.
2. If the N<sup>th</sup> bit from the low order bit is 1, carry bit is SET.

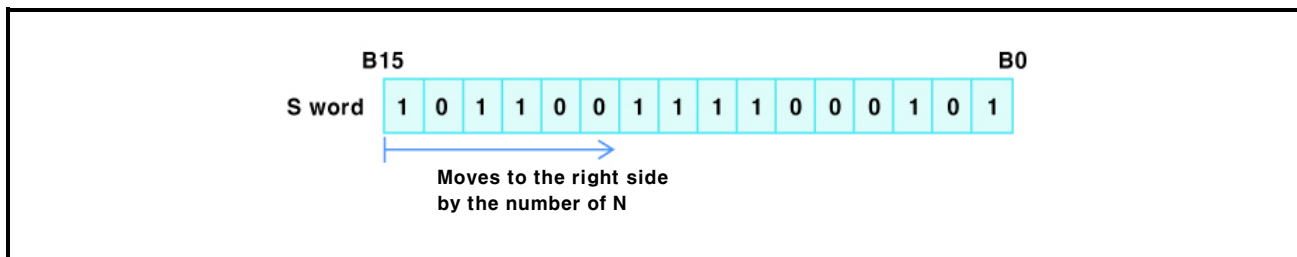

3.2.105 Movement instruction(ASFTR)

<b>Movement instruction</b>	<b>ASFTR</b>	<b>S</b>	<b>N1</b>	<b>N2</b>	Applicable model LP-S044, LP-S070	
<b>OP</b>	<b>DATA type</b>	<b>Available device / Description / Range</b>				
<b>S</b>	BIT	Y, F, T, C, M, UB			Error	
		Start bit position of the data to execute the operation				Zero
		Not applicable				
<b>N1</b>	WORD	X, Y, F, Z, T, C, M, S, L, D, UW, integer			Borrow	
		The number of bits from the designated position as S				Step
		0 to 32				
<b>N2</b>	WORD	X, Y, F, Z, T, C, M, S, L, D, UW, integer				
		The number of bits to rotate right side				
		0 to 32				

<Ladder>

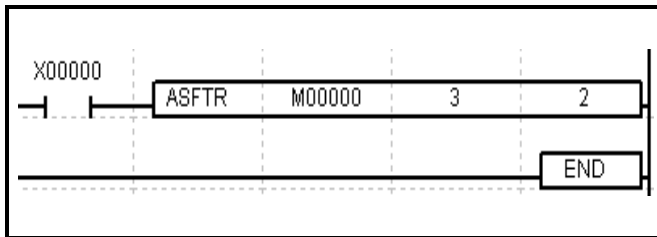

1. From the source bit, N1 bits moves to the right side as N2 in the range.
2. The high order bits, which are the number of movement, have "0" as their value.
3. If the value of N2 is greater than N1, the values from source bit to N bit are shifted to "0".

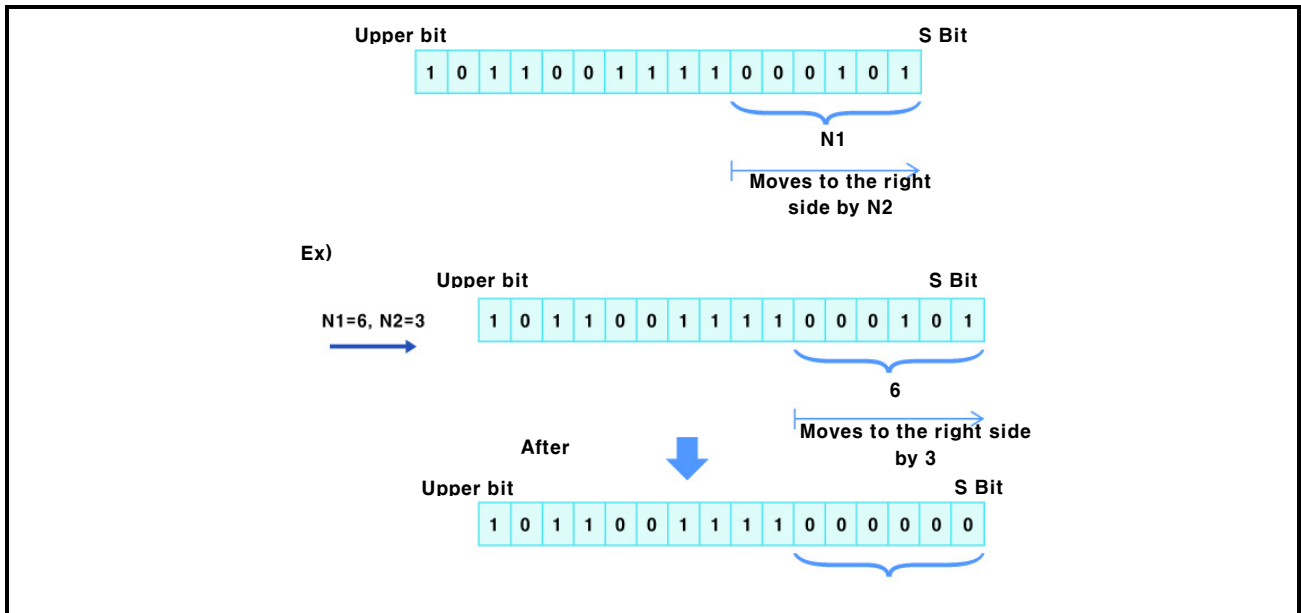

### 3.2.106 Movement instruction(SFTL)

<b>Movement instruction</b>		<b>SFTL</b>	<b>S</b>	<b>N</b>	Applicable model LP-S044, LP-S070				
OP	DATA type	Available device / Description / Range			Error	Zero	Carry	Borrow	Step
<b>S</b>	WORD	Y, F, Z, T, C, M, S, L, D, UW							6
		Data address to execute the operation							
		0(h0000) to 65535(hFFFF)							
<b>N</b>	WORD	X, Y, F, Z, T, C, M, S, L, D, UW, integer					⊙		
		The number of bits to rotate left side							
		0 to 16							

<Ladder>

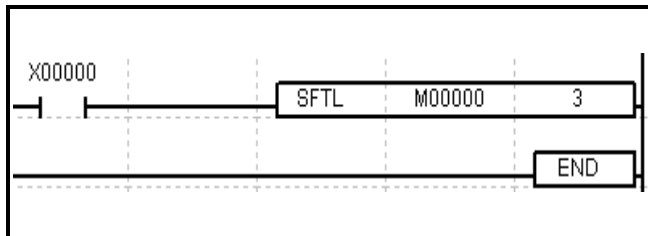

1. Within the source word, move the 16 bits of source word to the left by the number of N bits.
2. If the N<sup>th</sup> bit from the high order bit is 1, carry bit is SET.

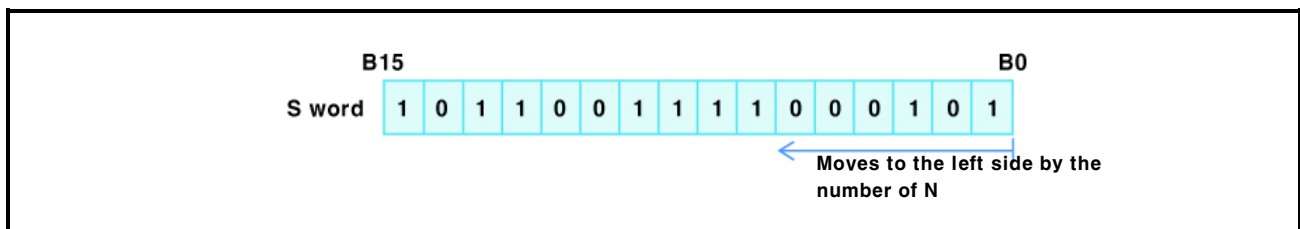

3.2.107 Movement instruction(ASFTL)

<b>Movement instruction</b>	<b>ASFTL</b>	<b>S</b>	<b>N1</b>	<b>N2</b>	Applicable model LP-S044, LP-S070
<b>OP</b>	<b>DATA type</b>	<b>Available device / Description / Range</b>			
<b>S</b>	BIT	Y, F, T, C, M, UB			Error
		Start bit position of the data to execute the operation			Zero
		Not applicable			Carry
<b>N1</b>	WORD	X, Y, F, Z, T, C, M, S, L, D, UW, integer			Borrow
		The number of bits from the designated position as S			Step
		0 to 32			9
<b>N2</b>	WORD	X, Y, F, Z, T, C, M, S, L, D, UW, integer			
		The number of bits to rotate left side			
		0 to 32			

<Ladder>

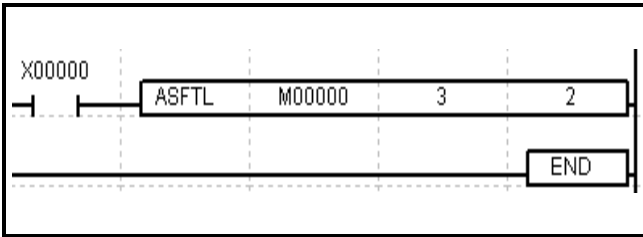

1. From the source bit, N1 bits moves to the left side as N2 in the range.
2. The low order bits, which are the number of movement, have "0" as their value.
3. If the value of N2 is greater than N1, the values of designated bits, from source bit to the N1, are shifted to "0".

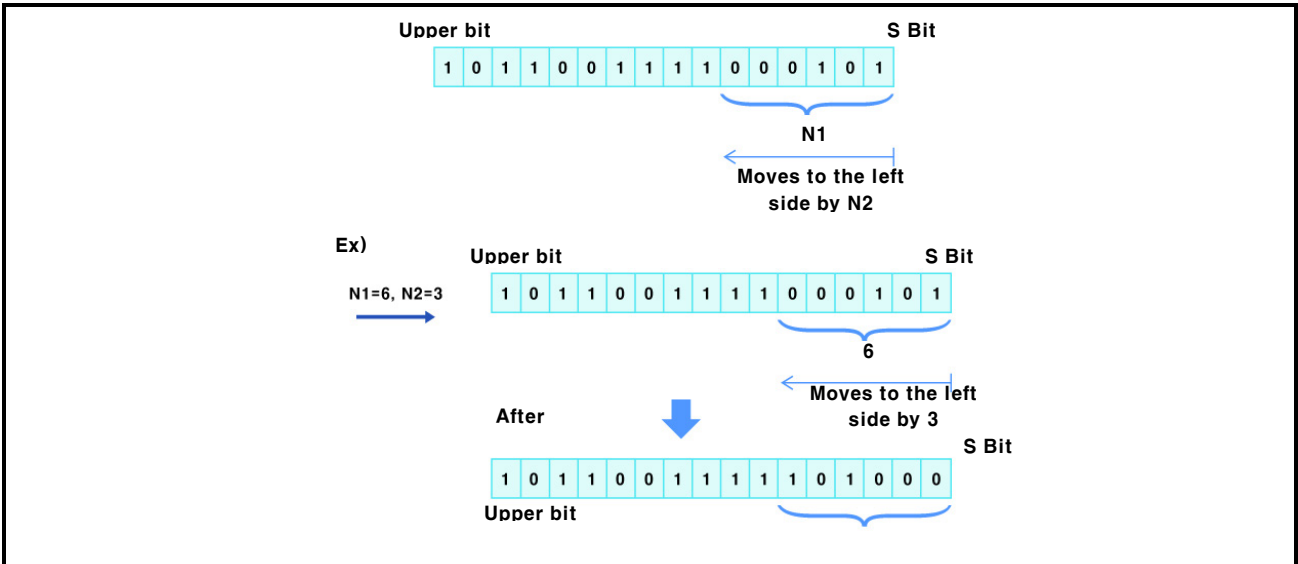

### 3.2.108 Movement instruction(WSFTR)

OP	DATA type	Available device / Description / Range	Error	Zero	Carry	Borrow	Step
S	WORD	Y, F, Z, T, C, M, S, L, D, UW					9
		Data address to execute the operation					
		0(h0000) to 65535(hFFFF)					
N1	WORD	X, Y, F, Z, T, C, M, S, L, D, UW, integer					
		The number of words from the designated position as S					
		To the remained device range in corresponding S area					
N2	WORD	X, Y, F, Z, T, C, M, S, L, D, UW, integer					
		The number of words to move to the right					
		To the range not greater than the N1 value					

<Ladder>

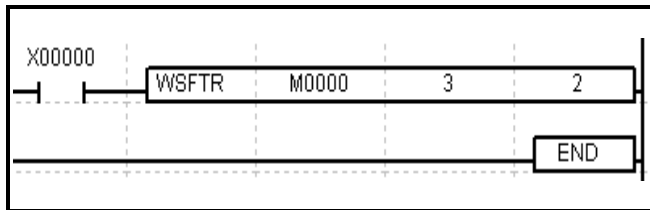

1. From the source word, N1 words moves to the right side as N2 in the range by word unit.
2. The high order words, which are the number of movement, have "0" as their value.

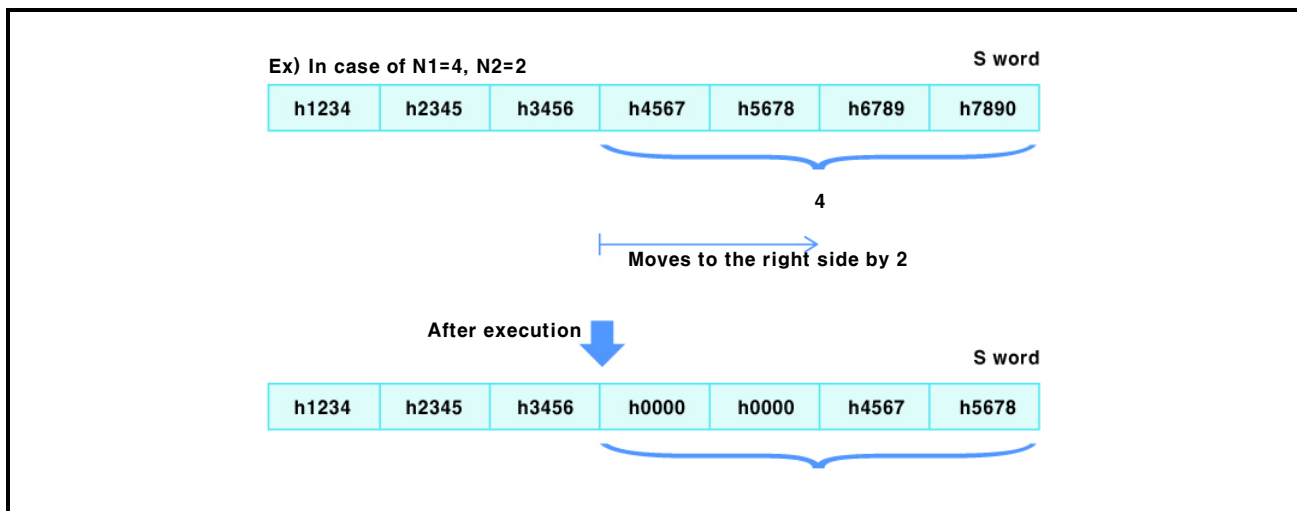

3.2.109 Movement instruction(WSFTL)

<b>Movement instruction</b>	<b>WSFTL</b>	<b>S</b>	<b>N1</b>	<b>N2</b>	Applicable model LP-S044, LP-S070
<b>OP</b>	<b>DATA type</b>	<b>Available device / Description / Range</b>			
<b>S</b>	WORD	Y, F, Z, T, C, M, S, L, D, UW			Error
		Data address to execute the operation			Zero
		0(h0000) to 65535(hFFFF)			Carry
<b>N1</b>	WORD	X, Y, F, Z, T, C, M, S, L, D, UW, integer			Borrow
		The number of words from the designated position as S			Step
		To the remained device range in corresponding S area			9
<b>N2</b>	WORD	X, Y, F, Z, T, C, M, S, L, D, UW, integer			
		The number of words to move to the left			
		To the range not greater than the N1 value			

<Ladder>

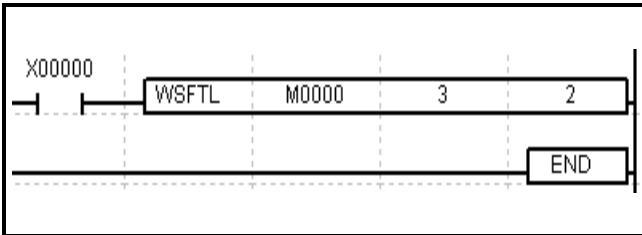

1. From the source word, N1 words moves to the left side as N2 in the range by word unit.
2. The lower order words, which are the number of movement, have "0" as their value.

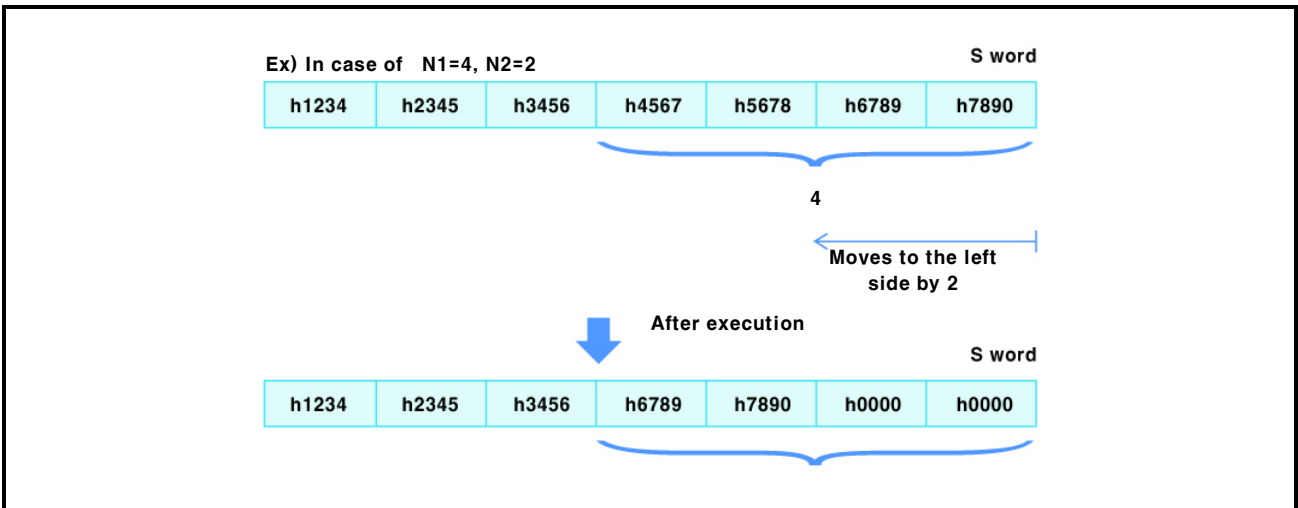

### 3.2.110 Arithmetic operation instruction(ADD)

<b>Arithmetic operation instruction</b>			<b>ADD</b>	<b>S1</b>	<b>S2</b>	<b>D</b>	Applicable model LP-S044, LP-S070				
OP	DATA type	Available device / Description / Range				Error	Zero	Carry	Borrow	Step	
<b>S1</b>	INT	X, Y, F, Z, T, C, M, S, L, D, UW, integer					⊙	⊙		7	
		Data address to execute the addition operation with S2									
		-32768(h8000) to 32767(h7FFF)									
<b>S2</b>	INT	X, Y, F, Z, T, C, M, S, L, D, UW, integer					⊙				
		Data address to execute the addition operation with S1									
		-32768(h8000) to 32767(h7FFF)									
<b>D</b>	INT	Y, F, Z, T, C, M, S, L, D, UW									
		Address to save the operation result									
		-32768(h8000) to 32767(h7FFF)									

<Ladder>

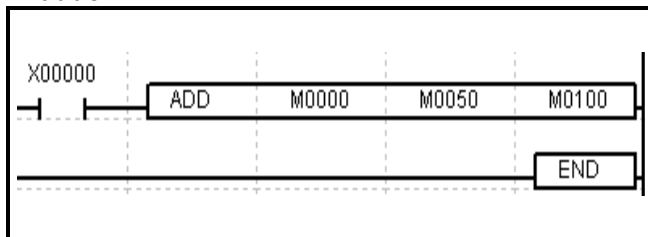

1. Adds the word values of S1 and S2, and then stores the result into the destination word D
2. Executes the Signed operation.  
(h8000(-32768) to hFFFF(-1) < 0 to h7FFF(32767))
3. If the result value exceeds 'h7FFF(32767)', carry flag is SET.
4. If the result value is h0000, zero flag is SET.

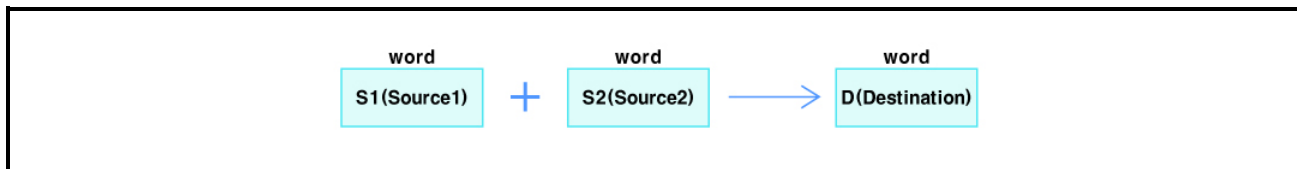



**3.2.111 Arithmetic operation instruction(DADD)**

<b>Arithmetic operation instruction</b>			<b>DADD</b>	<b>S1</b>	<b>S2</b>	<b>D</b>	Applicable model LP-S044, LP-S070					
OP	DATA type	Available device / Description / Range						Error	Zero	Carry	Borrow	Step
<b>S1</b>	DINT	X, Y, F, Z, T, C, M, S, L, D, UW, integer										
		Data address to execute the addition operation with S2 -2147483648(h80000000) to 2147483647(h7FFFFFFF)							⊙	⊙		7
<b>S2</b>	DINT	X, Y, F, Z, T, C, M, S, L, D, UW, integer										
		Data address to execute the addition operation with S1 -2147483648(h80000000) to 2147483647(h7FFFFFFF)										
<b>D</b>	DINT	Y, F, Z, T, C, M, S, L, D, UW										
		Address to save the operation result -2147483648(h80000000) to 2147483647(h7FFFFFFF)										

<Ladder>

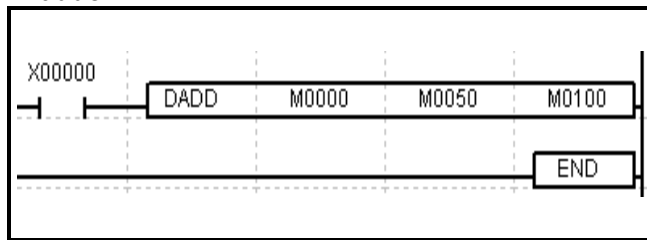

1. Adds the double word values of S1 and S2, and then stores the result into the destination double word D.
2. Executes the Signed operation.  
(h80000000(-2147483648) to hFFFFFFF(-1) < 0 to h7FFFFFFF(2147483647))
3. If the result value exceeds 'h7FFFFFFF (2147483647)', carry flag is SET.
4. If the result value is 'h00000000', zero flag is SET.

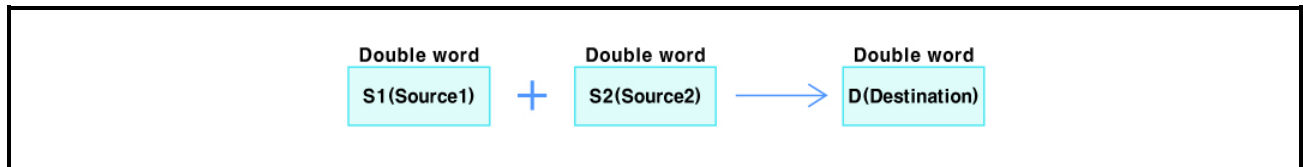

### 3.2.112 Arithmetic operation instruction(ADDU)

<b>Arithmetic operation instruction</b>			<b>ADDU</b>	<b>S1</b>	<b>S2</b>	<b>D</b>	Applicable model				
							LP-S044, LP-S070				
OP	DATA type	Available device / Description / Range					Error	Zero	Carry	Borrow	Step
<b>S1</b>	WORD	X, Y, F, Z, T, C, M, S, L, D, UW, integer						⊙	⊙		7
		Data address to execute the addition operation with S2 0(h0000) to 65535(hFFFF)									
<b>S2</b>	WORD	X, Y, F, Z, T, C, M, S, L, D, UW, integer									
		Data address to execute the addition operation with S1 0(h0000) to 65535(hFFFF)									
<b>D</b>	WORD	Y, F, Z, T, C, M, S, L, D, UW									
		Address to save the operation result 0(h0000) to 65535(hFFFF)									

<Ladder>

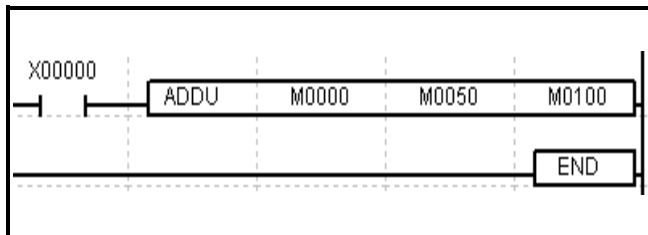

1. Adds the word values of S1 and S2 and then stores the result into the destination word D.
2. Executes the Unsigned operation.
3. If the result value exceeds 'hFFFF(65535)', carry flag is SET.
4. If the result value is 'h0000', zero flag is SET.

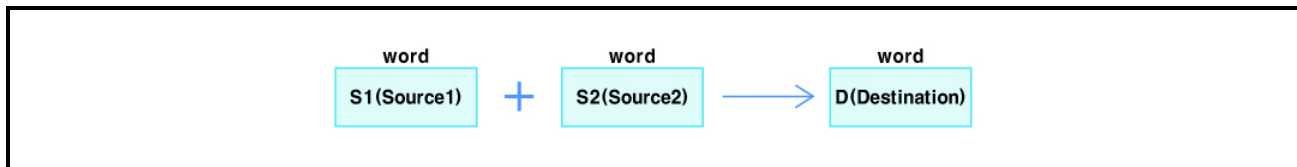

**3.2.113 Arithmetic operation instruction(DADDU)**

<b>Arithmetic operation instruction</b>			<b>DADDU</b>	<b>S1</b>	<b>S2</b>	<b>D</b>	Applicable model LP-S044, LP-S070					
OP	DATA type	Available device / Description / Range					Error	Zero	Carry	Borrow	Step	
<b>S1</b>	DWORD	X, Y, F, Z, T, C, M, S, L, D, UW, integer						<input type="checkbox"/>	<input checked="" type="checkbox"/>	<input checked="" type="checkbox"/>	<input type="checkbox"/>	7
		Data address to execute the addition operation with S2 0(h0000) to 4294967295(hFFFFFFF)										
<b>S2</b>	DWORD	X, Y, F, Z, T, C, M, S, L, D, UW, integer										
		Data address to execute the addition operation with S1 0(h0000) to 4294967295(hFFFFFFF)										
<b>D</b>	DWORD	Y, F, Z, T, C, M, S, L, D, UW										
		Address to save the operation result 0(h0000) to 4294967295(hFFFFFFF)										

<Ladder>

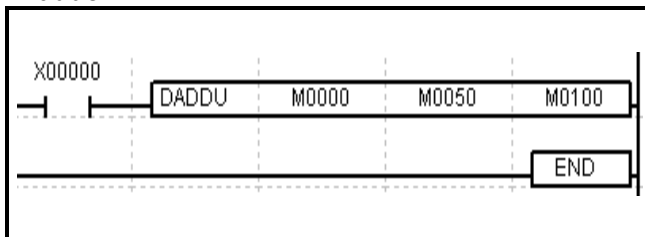

1. Adds the double word values of S1 and S2, and then stores the result into the destination double word D.
2. Executes the Unsigned operation.
3. If the result value exceeds 'hFFFFFFF (4294967295)', carry flag is SET.
4. If the result value is 'h0000', zero flag is SET.

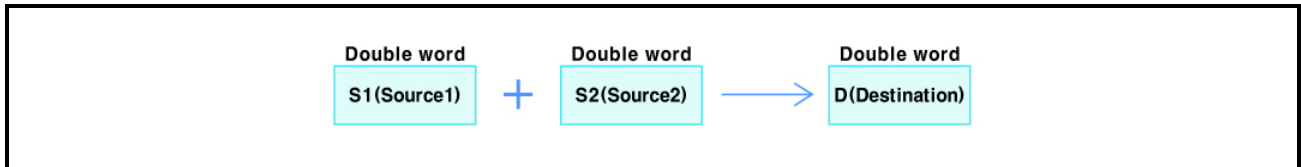

### 3.2.114 Arithmetic operation instruction(ADDL)

Arithmetic operation instruction		ADDL	S1	S2	D	N	Applicable model				
							LP-S044, LP-S070				
OP	DATA type	Available device / Description / Range					Error	Zero	Carry	Borrow	Step
S1	INT	X, Y, F, Z, T, C, M, S, L, D, UW, integer					<input type="checkbox"/>	<input type="checkbox"/>	<input type="checkbox"/>	<input type="checkbox"/>	9
		Data address to execute the addition operation with S2 -32768(h8000) to 32767(h7FFF)									
S2	INT	X, Y, F, Z, T, C, M, S, L, D, UW					<input type="checkbox"/>	<input type="checkbox"/>	<input type="checkbox"/>	<input type="checkbox"/>	
		Data address to execute the addition operation with S1 -32768(h8000) to 32767(h7FFF)									
D	INT	Y, F, Z, T, C, M, S, L, D, UW					<input type="checkbox"/>	<input type="checkbox"/>	<input type="checkbox"/>	<input type="checkbox"/>	
		Address to save the operation result -32768(h8000) to 32767(h7FFF)									
N	WORD	X, Y, F, Z, T, C, M, S, L, D, UW, integer					<input type="checkbox"/>	<input type="checkbox"/>	<input type="checkbox"/>	<input type="checkbox"/>	
		The number of S2 data address and saved address to execute the operation with S1 In the range within the corresponding device area of S2 and D									

<Ladder>

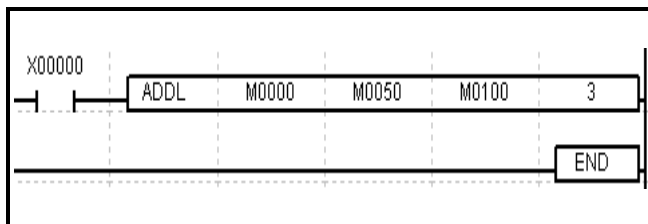

1. Adds the word value of S1 and the number of N word values beginning with S2 one by one, and then stores the number of N results into the number of N corresponding destination words beginning with word D.
2. Executes the Signed operation.  
(h8000(-32768) to hFFFF(-1) < 0 to h7FFF(32767))
3. If the result value is 'h0000', zero flag is SET.

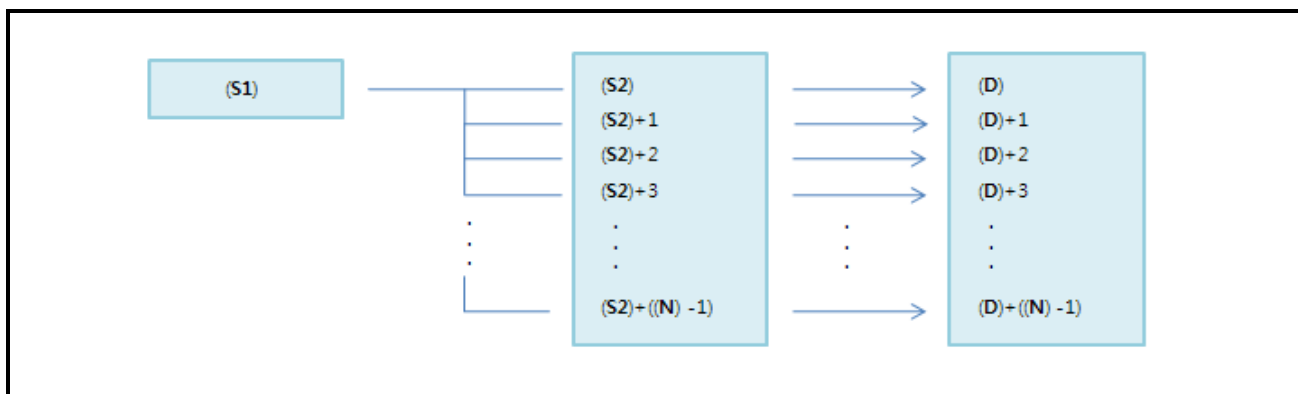
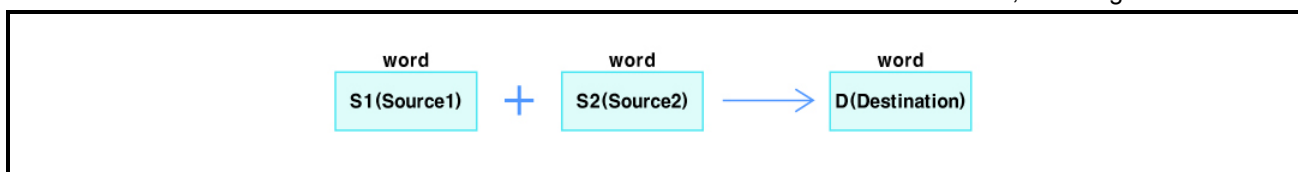

### 3.2.115 Arithmetic operation instruction(DADDL)

Arithmetic operation instruction			DADDL	S1	S2	D	N	Applicable model				
								LP-S044, LP-S070				
OP	DATA type	Available device / Description / Range						Error	Zero	Carry	Borrow	Step
S1	DINT	X, Y, F, Z, T, C, M, S, L, D, UW, integer							⊙	⊙		9
		Data address to execute the addition operation with S2 -2147483648(h80000000) to 2147483647(h7FFFFFFF)										
S2	DINT	X, Y, F, Z, T, C, M, S, L, D, UW							⊙	⊙		
		Data address to execute the addition operation with S1 -2147483648(h80000000) to 2147483647(h7FFFFFFF)										
D	DINT	Y, F, Z, T, C, M, S, L, D, UW										
		Address to save the operation result -2147483648(h80000000) to 2147483647(h7FFFFFFF)										
N	WORD	X, Y, F, Z, T, C, M, S, L, D, UW, integer										
		The number of S2 data address and saved address to execute the operation with S1 In the range within the corresponding device area of S2 and D										

<Ladder>

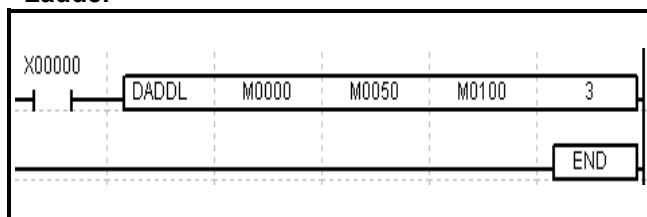

1. Adds the double word value of S1 and the number of N double word values beginning with S2 one by one, and then stores their results into the number of N corresponding destination double words beginning with double word D respectively.
2. Executes the Signed operation.  
(h80000000(-2147483648) to hFFFFFFF(-1) < 0 to h7FFFFFFF(2147483647))
3. If the result value is 'h00000000', zero flag is SET.

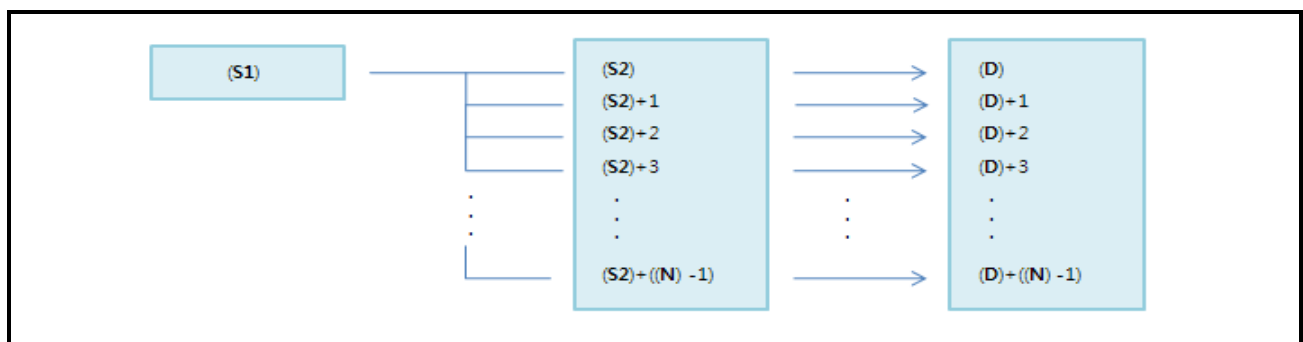
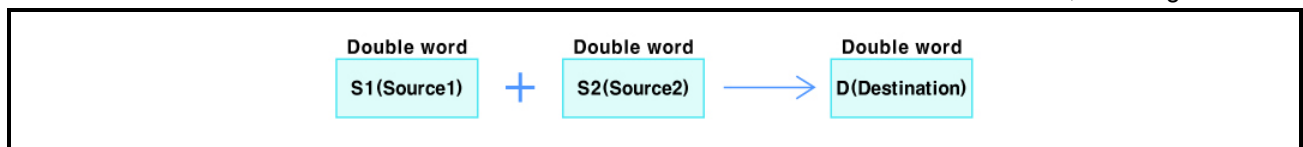

### 3.2.116 Arithmetic operation instruction(ADDLU)

Arithmetic operation instruction		ADDLU	S1	S2	D	N	Applicable model				
							LP-S044, LP-S070				
OP	DATA type	Available device / Description / Range					Error	Zero	Carry	Borrow	Step
S1	WORD	X, Y, F, Z, T, C, M, S, L, D, UW, integer						⊙	⊙		6
		Data address to execute the addition operation with S2									
		0(h0000) to 65535(hFFFF)									
S2	WORD	X, Y, F, Z, T, C, M, S, L, D, UW						⊙	⊙		
		Data address to execute the addition operation with S1									
		0(h0000) to 65535(hFFFF)									
D	WORD	Y, F, Z, T, C, M, S, L, D, UW						⊙	⊙		
		Address to save the operation result									
		0(h0000) to 65535(hFFFF)									
N	WORD	X, Y, F, Z, T, C, M, S, L, D, UW, integer						⊙	⊙		
		The number of S2 data address and saved address to execute the operation with S1									
		In the range within the corresponding device area of S2 and D									

<Ladder>

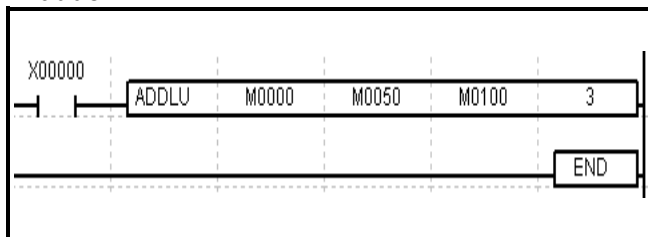

1. Adds the word value of S1 and the number of N word values beginning with S2 one by one, and then stores their results into the number of N corresponding destination words beginning with word D respectively.
2. Executes the Unsigned operation.
3. If the result value exceeds 'hFFFF(65535)' carry flag is SET.
4. If the result value is 'h0000', zero flag is SET.

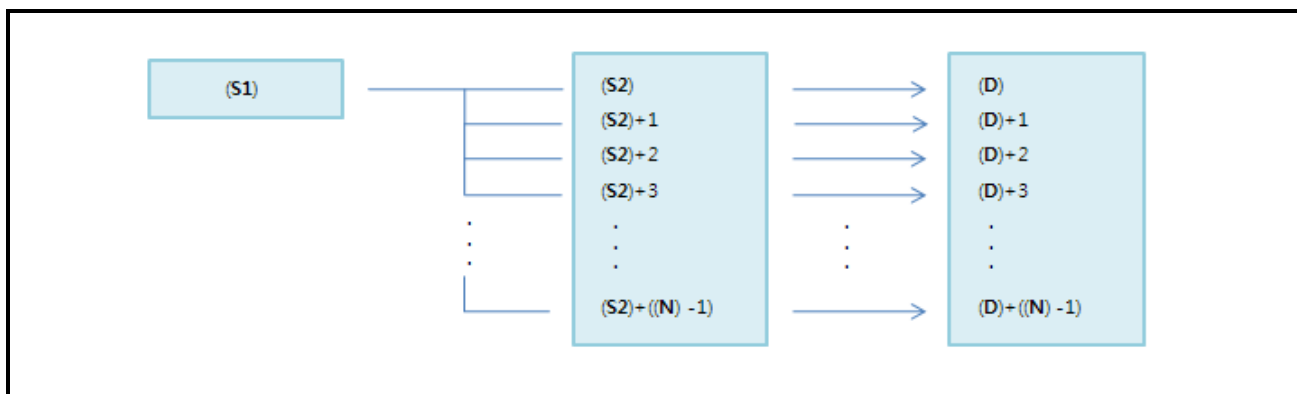
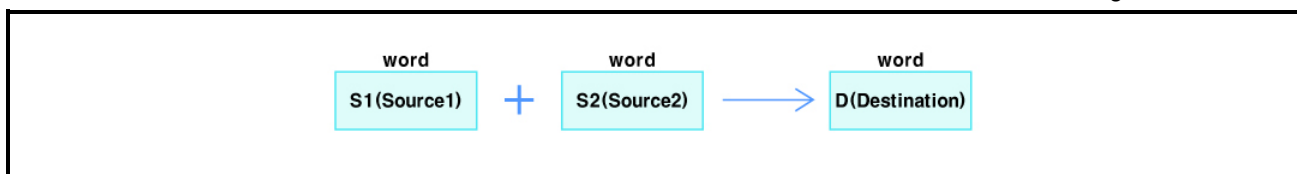

### 3.2.117 Arithmetic operation instruction(DADDLU)

Arithmetic operation instruction			<b>DADDLU</b>	<b>S1</b>	<b>S2</b>	<b>D</b>	<b>N</b>	Applicable model LP-S044, LP-S070				
OP	DATA type	Available device / Description / Range						Error	Zero	Carry	Borrow	Step
<b>S1</b>	DWORD	X, Y, F, Z, T, C, M, S, L, D, UW, integer							⊙	⊙		9
		Data address to execute the addition operation with S2 0(h0000) to 4294967295(hFFFFFFF)										
<b>S2</b>	DWORD	X, Y, F, Z, T, C, M, S, L, D, UW							⊙	⊙		9
		Data address to execute the addition operation with S1 0(h0000) to 4294967295(hFFFFFFF)										
<b>D</b>	DWORD	Y, F, Z, T, C, M, S, L, D, UW							⊙	⊙		9
		Address to save the operation result 0(h0000) to 4294967295(hFFFFFFF)										
<b>N</b>	WORD	X, Y, F, Z, T, C, M, S, L, D, UW, integer							⊙	⊙		9
		The number of S2 data address and saved address to execute the operation with S1 In the range within the corresponding device area of S2 and D										

<Ladder>

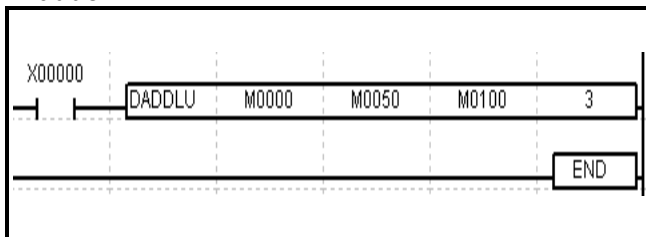

1. Adds the double word value of S1 and the number of N double word values beginning with S2 one by one, and then stores their results into the number of N corresponding destination double words beginning with double word D respectively.
2. Executes the Unsigned operation.
3. If the result value exceeds 'hFFFFFFF' (4294967295), carry flag is SET.
4. If the result value is 'h0000', zero flag is SET.

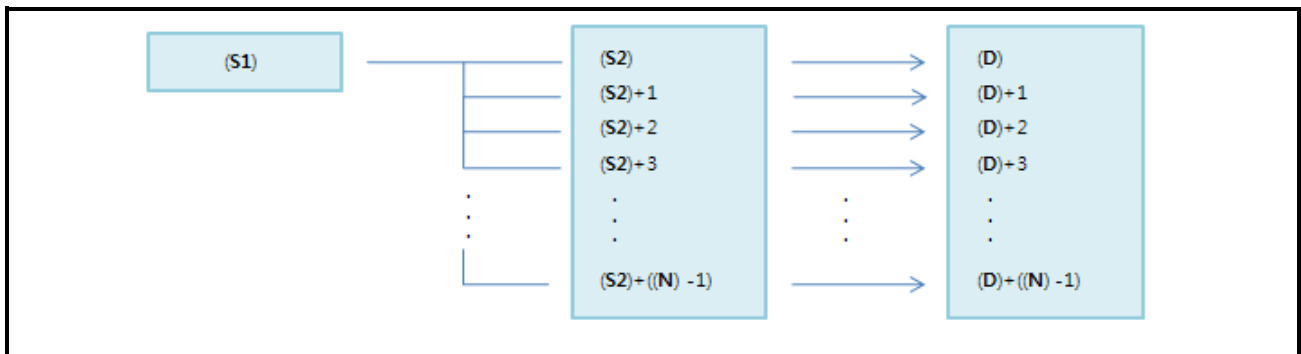
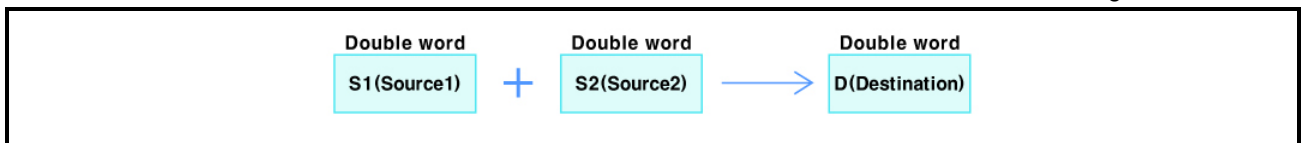

### 3.2.118 Arithmetic operation instruction(SUB)

<b>Arithmetic operation instruction</b>			<b>SUB</b>	<b>S1</b>	<b>S2</b>	<b>D</b>	Applicable model LP-S044, LP-S070				
OP	DATA type	Available device / Description / Range				Error	Zero	Carry	Borrow	Step	
<b>S1</b>	INT	X, Y, F, Z, T, C, M, S, L, D, UW, integer					⊙		⊙	7	
		Data address to execute the subtraction operation with S2									
		-32768(h8000) to 32767(h7FFF)									
<b>S2</b>	INT	X, Y, F, Z, T, C, M, S, L, D, UW, integer									
		Data address to execute the subtraction operation with S1									
		-32768(h8000) to 32767(h7FFF)									
<b>D</b>	INT	Y, F, Z, T, C, M, S, L, D, UW									
		Address to save the operation result									
		-32768(h8000) to 32767(h7FFF)									

<Ladder>

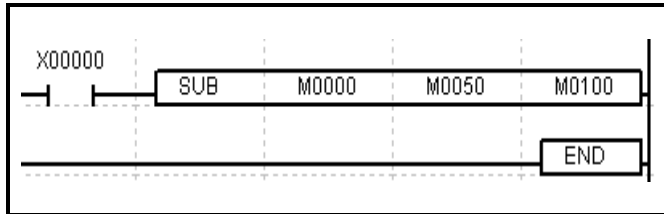

1. Subtracts the word value of S2 from the word value of S1 and then stores the result into the destination word D.
2. Executes the Signed operation.  
(h8000(-32768) to hFFFF(-1) < 0 to h7FFF(32767))
3. If the result value is 'h0000', zero flag occurs.

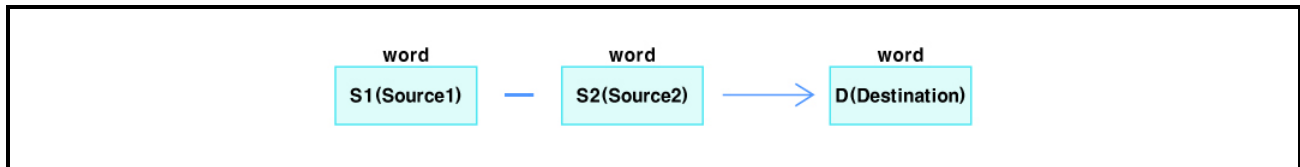



### 3.2.119 Arithmetic operation instruction(DSUB)

<b>Arithmetic operation instruction</b>			<b>DSUB</b>	<b>S1</b>	<b>S2</b>	<b>D</b>	Applicable model LP-S044, LP-S070				
OP	DATA type	Available device / Description / Range					Error	Zero	Carry	Borrow	Step
S1	DINT	X, Y, F, Z, T, C, M, S, L, D, UW, integer					<input type="checkbox"/>	<input checked="" type="checkbox"/>	<input type="checkbox"/>	<input checked="" type="checkbox"/>	<input type="checkbox"/>
		Data address to execute the subtraction operation with S2									
		-2147483648(h80000000) to 2147483647(hFFFFFFFF)									
S2	DINT	X, Y, F, Z, T, C, M, S, L, D, UW, integer					<input type="checkbox"/>	<input checked="" type="checkbox"/>	<input type="checkbox"/>	<input checked="" type="checkbox"/>	<input type="checkbox"/>
		Data address to execute the subtraction operation with S1									
		-2147483648(h80000000) to 2147483647(hFFFFFFFF)									
D	DINT	Y, F, Z, T, C, M, S, L, D, UW					<input type="checkbox"/>	<input checked="" type="checkbox"/>	<input type="checkbox"/>	<input checked="" type="checkbox"/>	<input type="checkbox"/>
		Address to save the operation result									
		-2147483648(h80000000) to 2147483647(hFFFFFFFF)									

<Ladder>

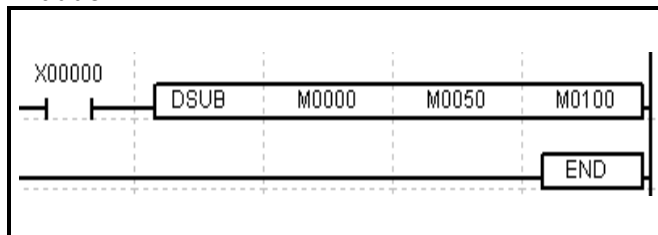

1. Subtracts double word value of S2 from the double word value of S1 and then stores the result into the destination double word D.
2. Executes the Signed operation.  
(h80000000(-2147483648) to hFFFFFFFF(-1) < 0 to h7FFFFFFF(2147483647))
3. If the result value is 'h00000000', zero flag occurs.

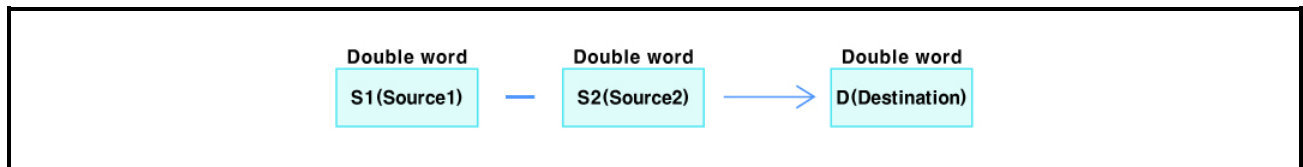

### 3.2.120 Arithmetic operation instruction(SUBU)

<b>Arithmetic operation instruction</b>			<b>SUBU</b>	<b>S1</b>	<b>S2</b>	<b>D</b>	Applicable model				
							LP-S044, LP-S070				
OP	DATA type	Available device / Description / Range					Error	Zero	Carry	Borrow	Step
<b>S1</b>	WORD	X, Y, F, Z, T, C, M, S, L, D, UW, integer						⊙		⊙	7
		Data address to execute the subtraction operation with S2									
		0(h0000) to 65535(hFFFF)									
<b>S2</b>	WORD	X, Y, F, Z, T, C, M, S, L, D, UW, integer									
		Data address to execute the subtraction operation with S1									
		0(h0000) to 65535(hFFFF)									
<b>D</b>	WORD	Y, F, Z, T, C, M, S, L, D, UW									
		Address to save the operation result									
		0(h0000) to 65535(hFFFF)									

<Ladder>

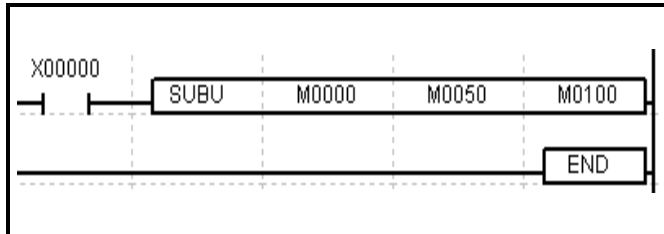

1. Subtracts the word value of S2 from the word value of S1 and then stores the result into the destination word D.
2. Executes the Unsigned operation.
3. If the result value is 'h0000' or out of this, borrow flag occurs.
4. If the result value is 'h0000', zero flag occurs.

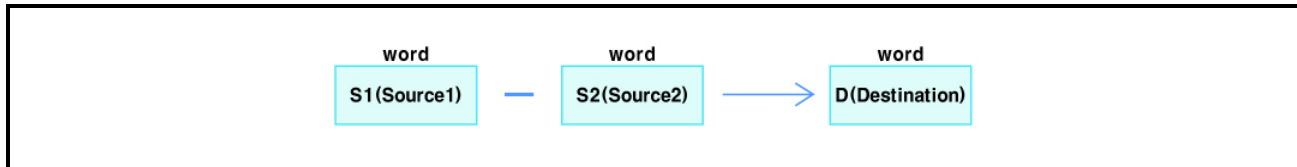

### 3.2.121 Arithmetic operation instruction(DSUBU)

<b>Arithmetic operation instruction</b>			<b>DSUBU</b>	<b>S1</b>	<b>S2</b>	<b>D</b>	Applicable model LP-S044, LP-S070				
OP	DATA type	Available device / Description / Range					Error	Zero	Carry	Borrow	Step
S1	DWORD	X, Y, F, Z, T, C, M, S, L, D, UW, integer					<input type="checkbox"/>	<input checked="" type="checkbox"/>	<input type="checkbox"/>	<input checked="" type="checkbox"/>	7
		Data address to execute the subtraction operation with S2									
		0(h0000) to 4294967295(hFFFFFFF)									
S2	DWORD	X, Y, F, Z, T, C, M, S, L, D, UW, integer					<input type="checkbox"/>	<input type="checkbox"/>	<input type="checkbox"/>	<input type="checkbox"/>	
		Data address to execute the subtraction operation with S1									
		0(h0000) to 4294967295(hFFFFFFF)									
D	DWORD	Y, F, Z, T, C, M, S, L, D, UW					<input type="checkbox"/>	<input type="checkbox"/>	<input type="checkbox"/>	<input type="checkbox"/>	
		Address to save the operation result									
		0(h0000) to 4294967295(hFFFFFFF)									

<Ladder>

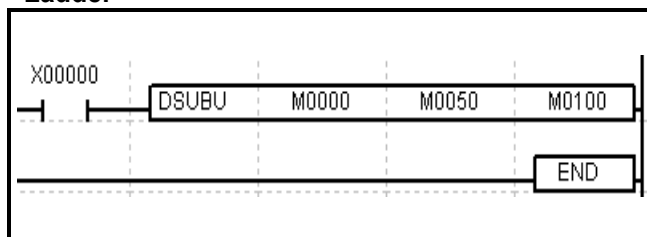

1. Subtract the double word value of S2 from the double word value of S1 and then store the result into the destination double word D.
2. Executes the Unsigned operation.
3. If the result value is 'h00000000' or out of this, borrow flag occurs.
4. If the result value 'h00000000', zero flag occurs.

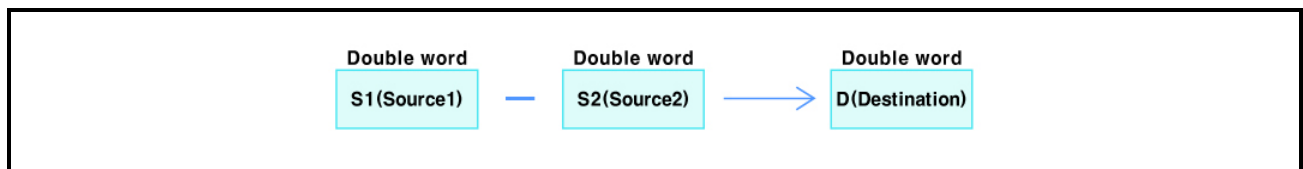

### 3.2.122 Arithmetic operation instruction(SUBL)

Arithmetic operation instruction		SUBL	S1	S2	D	N	N	Applicable model				
								LP-S044, LP-S070				
OP	DATA type	Available device / Description / Range						Error	Zero	Carry	Borrow	Step
S1	INT	X, Y, F, Z, T, C, M, S, L, D, UW, integer						<input type="checkbox"/>	<input type="checkbox"/>	<input type="checkbox"/>	<input type="checkbox"/>	6
		Data address to execute the subtraction operation with S2 -32768(h8000) to 32767(h7FFF)										
S2	INT	X, Y, F, Z, T, C, M, S, L, D, UW						<input type="checkbox"/>	<input checked="" type="checkbox"/>	<input type="checkbox"/>	<input checked="" type="checkbox"/>	6
		Data address to execute the subtraction operation with S1 -32768(h8000) to 32767(h7FFF)										
D	INT	Y, F, Z, T, C, M, S, L, D, UW						<input type="checkbox"/>	<input type="checkbox"/>	<input type="checkbox"/>	<input type="checkbox"/>	6
		Address to save the operation result -32768(h8000) to 32767(h7FFF)										
N	WORD	X, Y, F, Z, T, C, M, S, L, D, UW, integer						<input type="checkbox"/>	<input type="checkbox"/>	<input type="checkbox"/>	<input type="checkbox"/>	6
		The number of S2 data address and saved address to execute the operation with S1 In the range within the corresponding device area of S2 and D										

<Ladder>

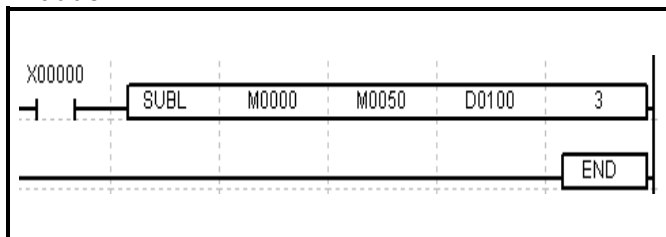

1. Subtracts the number of N word values, which are from S2 to S2(N-1), from the double word value of S1 respectively, and then stores the result into the number of N corresponding destination double words beginning with the word D.
2. Executes the Signed operation.  
(h8000(-32768) to hFFFF(-1) < 0 to h7FFF(32767))
3. If the result value is 'h0000', zero flag occurs.

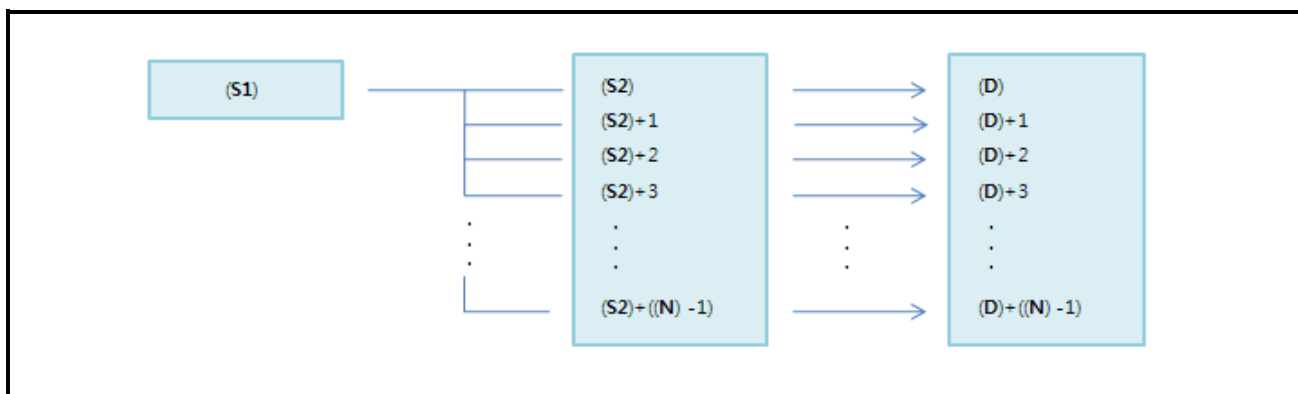
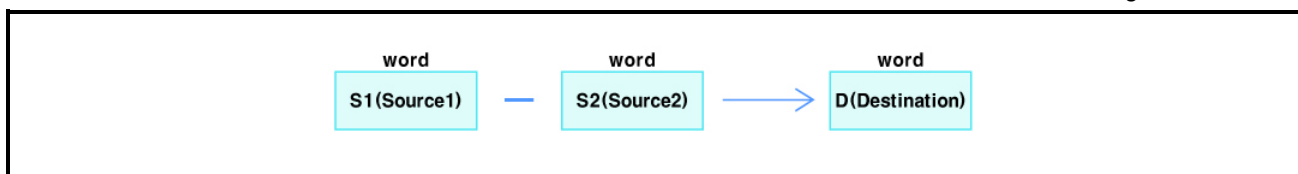

### 3.2.123 Arithmetic operation instruction(DSUBL)

Arithmetic operation instruction		DSUBL	S2	D	N	Applicable model LP-S044, LP-S070				
OP	DATA type	Available device / Description / Range				Error	Zero	Carry	Borrow	Step
S1	DINT	X, Y, F, Z, T, C, M, S, L, D, UW, integer					⊙		⊙	9
		Data address to execute the subtraction operation with S2								
		-2147483648(h80000000) to 2147483647(h7FFFFFFF)								
S2	DINT	X, Y, F, Z, T, C, M, S, L, D, UW					⊙		⊙	9
		Data address to execute the subtraction operation with S1								
		-2147483648(h80000000) to 2147483647(h7FFFFFFF)								
D	DINT	Y, F, Z, T, C, M, S, L, D, UW					⊙		⊙	9
		Address to save the operation result								
		-2147483648(h80000000) to 2147483647(h7FFFFFFF)								
N	WORD	X, Y, F, Z, T, C, M, S, L, D, UW, integer					⊙		⊙	9
		The number of S2 data address and saved address to execute the operation with S1								
		In the range within the corresponding device area of S2 and D								

<Ladder>

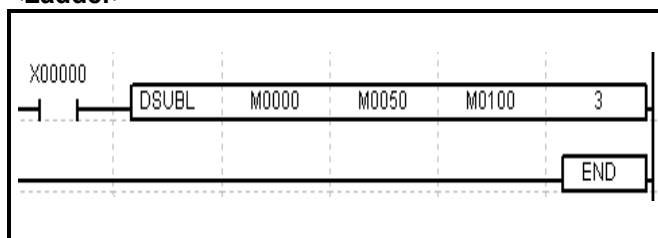

1. Subtracts the number of N double word values, which are from S2 to S2(N-1), from double word value of S1 respectively, and then stores the result into the number of N corresponding destination double words beginning with the double word D.
2. Executes the Signed operation.  
(h80000000(-2147483648) to hFFFFFFF(-1) < 0 to h7FFFFFFF(2147483647))
3. If the result value is 'h00000000', zero flag occurs.

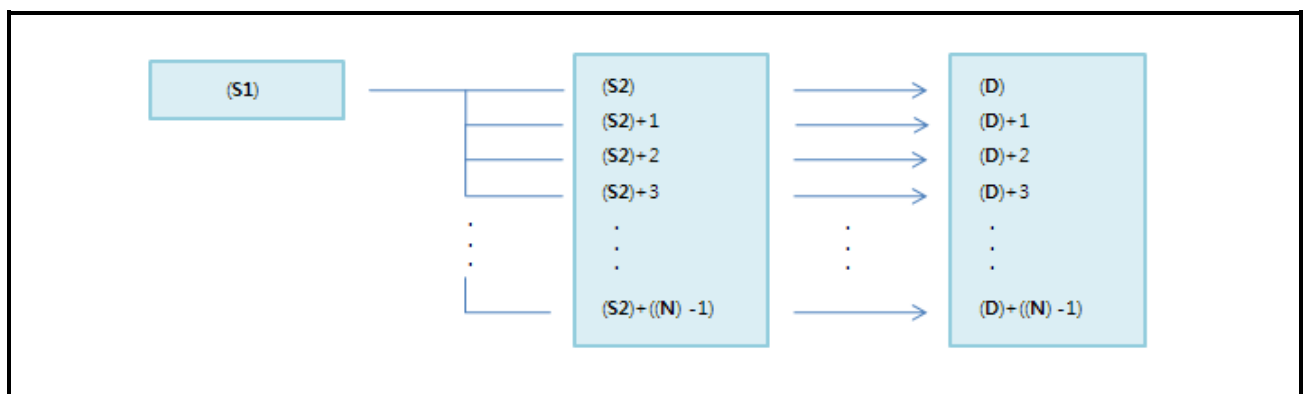
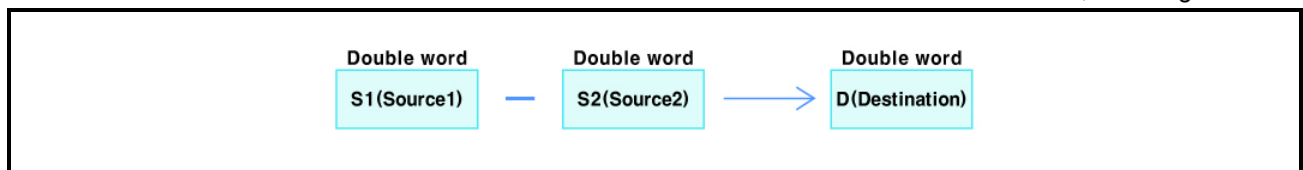

### 3.2.124 Arithmetic operation instruction(SUBLU)

Arithmetic operation instruction		SUBLU	S1	S2	D	N	Applicable model				
							LP-S044, LP-S070				
OP	DATA type	Available device / Description / Range					Error	Zero	Carry	Borrow	Step
S1	WORD	X, Y, F, Z, T, C, M, S, L, D, UW, integer					<input type="checkbox"/>	<input type="checkbox"/>	<input type="checkbox"/>	<input type="checkbox"/>	<input type="checkbox"/>
		Data address to execute the subtraction operation with S2 0(h0000) to 65535(hFFFF)									
S2	WORD	X, Y, F, Z, T, C, M, S, L, D, UW					<input type="checkbox"/>	<input checked="" type="checkbox"/>	<input type="checkbox"/>	<input checked="" type="checkbox"/>	6
		Data address to execute the subtraction operation with S1 0(h0000) to 65535(hFFFF)									
D	WORD	Y, F, Z, T, C, M, S, L, D, UW					<input type="checkbox"/>	<input type="checkbox"/>	<input type="checkbox"/>	<input type="checkbox"/>	<input type="checkbox"/>
		Address to save the operation result 0(h0000) to 65535(hFFFF)									
N	WORD	X, Y, F, Z, T, C, M, S, L, D, UW, integer					<input type="checkbox"/>	<input type="checkbox"/>	<input type="checkbox"/>	<input type="checkbox"/>	<input type="checkbox"/>
		The number of S2 data address and saved address to execute the operation with S1 In the range within the corresponding device area of S2 and D									

<Ladder>

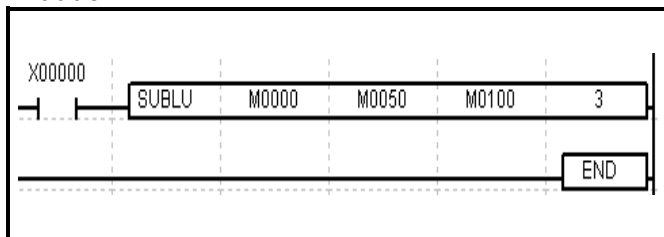

1. Subtracts the number of N word values, which are from S2 to S2(N-1), from word value of S1 respectively, and then stores the result into the number of N corresponding destination words beginning with the word D.
2. Executes the Unsigned operation.
3. If the result value is 'h0000' or out of this, borrow flag occurs.
4. If the result value is 'h0000', zero flag occurs.

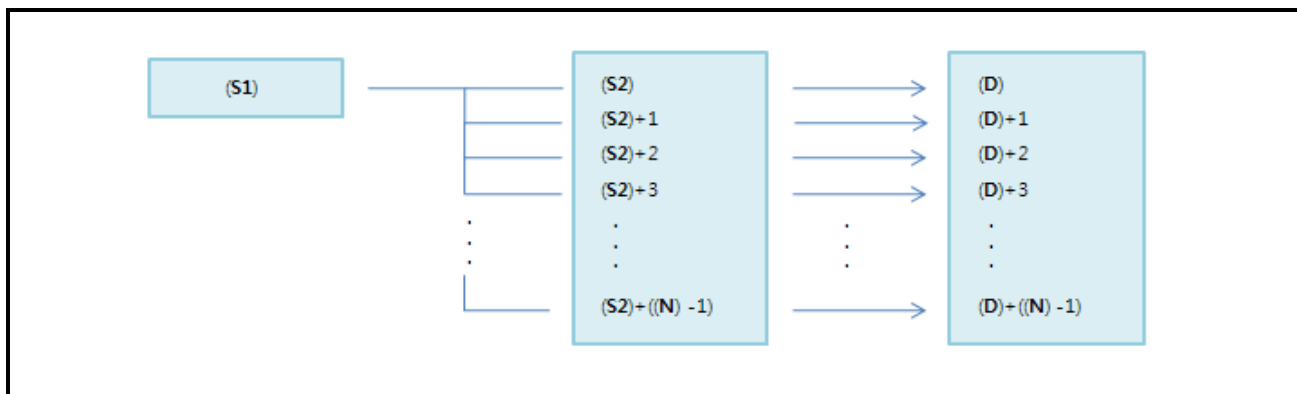
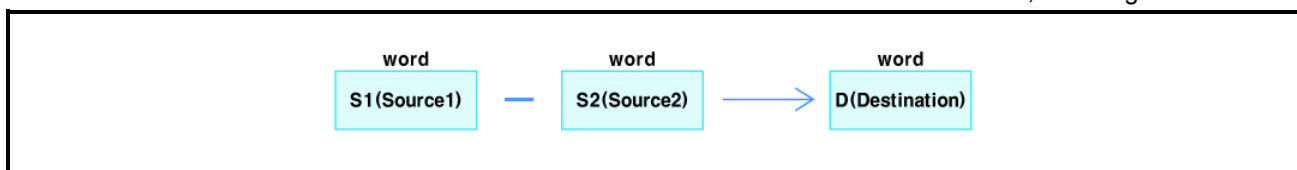

**3.2.125 Arithmetic operation instruction(DSUBLU)**

<b>Arithmetic operation instruction</b>			<b>DSUBLU</b>	<b>S1</b>	<b>S2</b>	<b>D</b>	<b>N</b>	Applicable model LP-S044, LP-S070				
OP	DATA type	Available device / Description / Range						Error	Zero	Carry	Borrow	Step
<b>S1</b>	DWORD	X, Y, F, Z, T, C, M, S, L, D, UW, integer						<input type="checkbox"/>	<input type="checkbox"/>	<input type="checkbox"/>	<input checked="" type="checkbox"/>	9
		Data address to execute the subtraction operation with S2										
		0(h0000) to 4294967295(hFFFFFFF)										
<b>S2</b>	DWORD	X, Y, F, Z, T, C, M, S, L, D, UW						<input type="checkbox"/>	<input type="checkbox"/>	<input type="checkbox"/>	<input checked="" type="checkbox"/>	9
		Data address to execute the subtraction operation with S1										
		0(h0000) to 4294967295(hFFFFFFF)										
<b>D</b>	DWORD	Y, F, Z, T, C, M, S, L, D, UW						<input type="checkbox"/>	<input type="checkbox"/>	<input type="checkbox"/>	<input checked="" type="checkbox"/>	9
		Address to save the operation result										
		0(h0000) to 4294967295(hFFFFFFF)										
<b>N</b>	WORD	X, Y, F, Z, T, C, M, S, L, D, UW, integer						<input type="checkbox"/>	<input type="checkbox"/>	<input type="checkbox"/>	<input checked="" type="checkbox"/>	9
		The number of S2 data address and saved address to execute the operation with S1										
		In the range within the corresponding device area of S2 and D										

<Ladder>

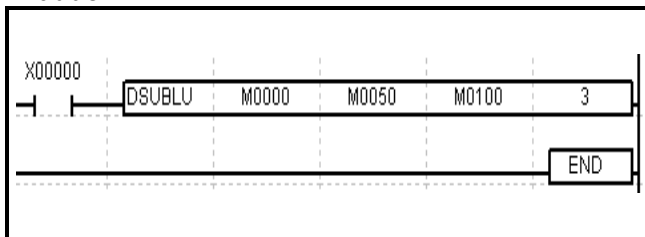

1. Subtracts the number of N double word values, which are from S2 to S2(N-1), from double word value of S1 respectively, and then stores the result into the number of N corresponding destination beginning with the double word D.
2. Executes the Unsigned operation.
3. If the result value is 'h00000000' or out of this, borrow flag occurs.
4. If the result value 'h00000000', zero flag occurs.

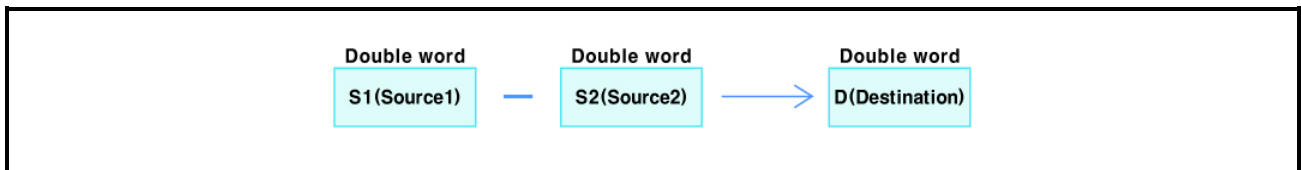

### 3.2.126 Arithmetic operation instruction(MUL)

<b>Arithmetic operation instruction</b>			<b>MUL</b>	<b>S1</b>	<b>S2</b>	<b>D</b>	Applicable model LP-S044, LP-S070				
OP	DATA type	Available device / Description / Range					Error	Zero	Carry	Borrow	Step
<b>S1</b>	INT	X, Y, F, Z, T, C, M, S, L, D, UW, integer						⊙	⊙		7
		Data address to execute the multiplication with S2 -32768(h8000) to 32767(h7FFF)									
<b>S2</b>	INT	X, Y, F, Z, T, C, M, S, L, D, UW, integer									
		Data address to execute the multiplication with S1 -32768(h8000) to 32767(h7FFF)									
<b>D</b>	DINT	Y, F, Z, T, C, M, S, L, D, UW									
		Address to save the operation result -2147483648(h80000000) to 2147483647(hFFFFFFF)									

<Ladder>

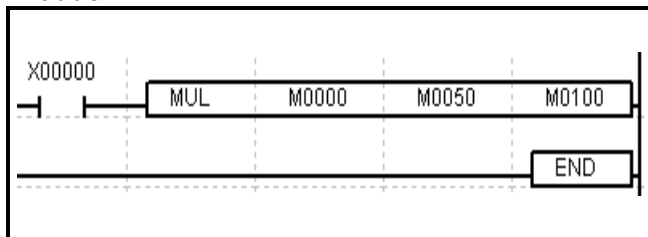

1. Multiplies the word value of S1 and that of S2, and then stores the result into the destination double word "D".
2. Executes the Signed operation.
3. If the result value is '0', zero flag occurs.

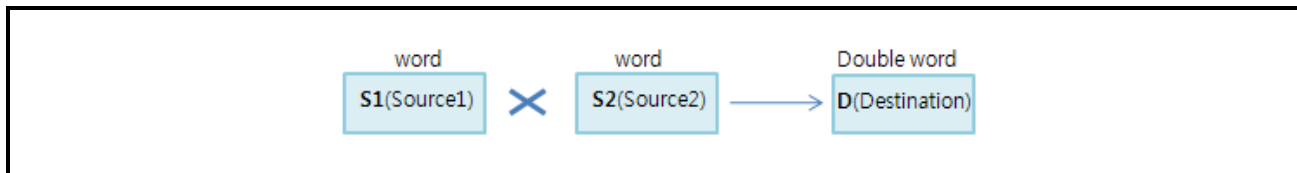



### 3.2.127 Arithmetic operation instruction(DMUL)

Arithmetic operation instruction			DMUL	S1	S2	D	Applicable model LP-S044, LP-S070				
OP	DATA type	Available device / Description / Range					Error	Zero	Carry	Borrow	Step
S1	DINT	X, Y, F, Z, T, C, M, S, L, D, UW, integer						Zero	Carry	Borrow	Step
		Data address to execute the multiplication with S2 -2147483648(h80000000) to 2147483647(hFFFFFFF)									
S2	DINT	X, Y, F, Z, T, C, M, S, L, D, UW, integer						Zero	Carry	Borrow	Step
		Data address to execute the multiplication with S1 -2147483648(h80000000) to 2147483647(hFFFFFFF)									
D	QWORD	Y, F, Z, T, C, M, S, L, D, UW						Zero	Carry	Borrow	Step
		Address to save the operation result									

<Ladder>

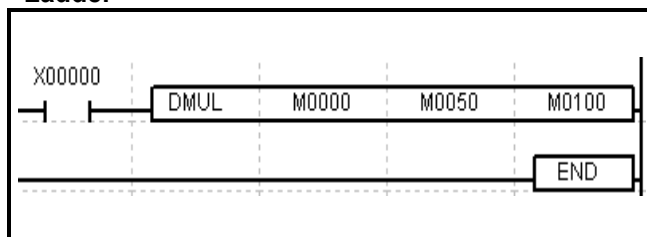

1. Multiplies the double word value of S1 and that of S2, and then stores the result into the destination "Quad Word D".
2. Executes the Signed operation.
3. If the result value is '0', zero flag is SET.

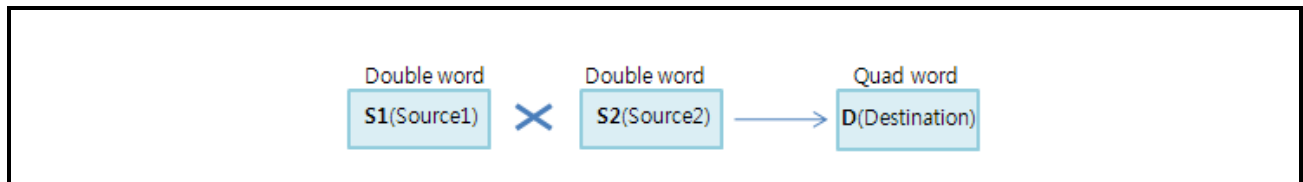

### 3.2.128 Arithmetic operation instruction(MULU)

<b>Arithmetic operation instruction</b>		<b>MULU</b>	<b>S1</b>	<b>S2</b>	<b>D</b>	Applicable model LP-S044, LP-S070				
OP	DATA type	Available device / Description / Range				Error	Zero	Carry	Borrow	Step
<b>S1</b>	WORD	X, Y, F, Z, T, C, M, S, L, D, UW, integer					⊙	⊙		7
		Data address to execute the multiplication with S2 0(h0000) to 65535(hFFFF)								
<b>S2</b>	WORD	X, Y, F, Z, T, C, M, S, L, D, UW, integer								
		Data address to execute the multiplication with S1 0(h0000) to 65535(hFFFF)								
<b>D</b>	DWORD	Y, F, Z, T, C, M, S, L, D, UW								
		Address to save the operation result 0(h0000) to 4294967295(hFFFFFFFF)								

<Ladder>

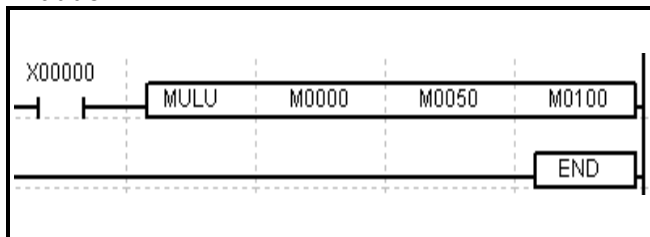

1. Multiplies the word value of S1 and that of S2, and then stores the result into the destination “Double Word DW”.
2. Executes the Unsigned operation.
3. If the result value is '0', zero flag occurs.

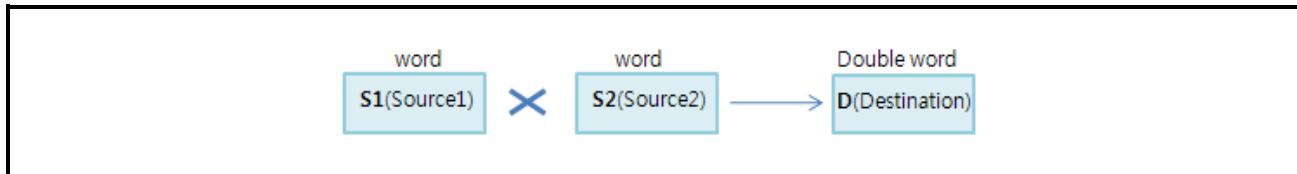

### 3.2.129 Arithmetic operation instruction(DMULU)

<b>Arithmetic operation instruction</b>			<b>DMULU</b>	<b>S1</b>	<b>S2</b>	<b>D</b>	Applicable model LP-S044, LP-S070				
OP	DATA type	Available device / Description / Range					Error	Zero	Carry	Borrow	Step
S1	DWORD	X, Y, F, Z, T, C, M, S, L, D, UW, integer					<input type="checkbox"/>	<input checked="" type="checkbox"/>	<input checked="" type="checkbox"/>	<input type="checkbox"/>	7
		Data address to execute the multiplication with S2 0(h0000) to 4294967295(hFFFFFFF)									
S2	DWORD	X, Y, F, Z, T, C, M, S, L, D, UW, integer					<input type="checkbox"/>	<input type="checkbox"/>	<input type="checkbox"/>	<input type="checkbox"/>	
		Data address to execute the multiplication with S1 0(h0000) to 4294967295(hFFFFFFF)									
D	QWORD	Y, F, Z, T, C, M, S, L, D, UW					<input type="checkbox"/>	<input type="checkbox"/>	<input type="checkbox"/>	<input type="checkbox"/>	
		Address to save the operation result									

<Ladder>

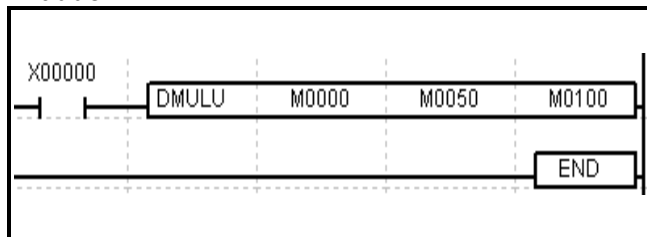

1. Multiplies the double word value of S1 and that of S2, and then stores the result into the destination "Quad Word D".
2. Executes the Unsigned operation.
3. If the result value is '0', zero flag occurs.

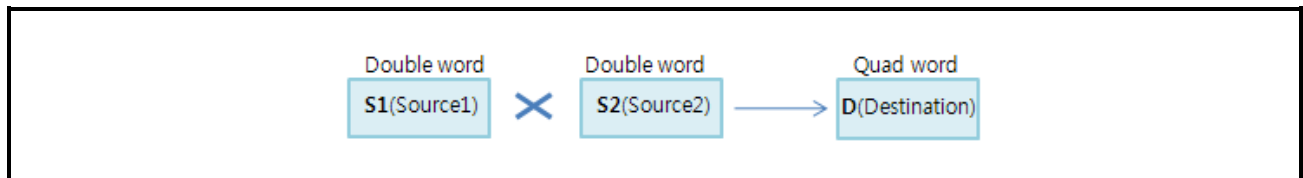

### 3.2.130 Arithmetic operation instruction(MULL)

Arithmetic operation instruction		MULL	S1	S2	D	N	Applicable model				
							LP-S044, LP-S070				
OP	DATA type	Available device / Description / Range					Error	Zero	Carry	Borrow	Step
S1	INT	X, Y, F, Z, T, C, M, S, L, D, UW, integer					Error	Zero	Carry	Borrow	Step
		Data address to execute the multiplication with S2 -32768(h8000) to 32767(h7FFF)									
S2	INT	X, Y, F, Z, T, C, M, S, L, D, UW					Error	Zero	Carry	Borrow	Step
		Data address to execute the multiplication with S1 -32768(h8000) to 32767(h7FFF)									
D	DINT	Y, F, Z, T, C, M, S, L, D, UW					Error	Zero	Carry	Borrow	Step
		Address to save the operation result -2147483648(h80000000) to 2147483647(hFFFFFFF)									
N	WORD	X, Y, F, Z, T, C, M, S, L, D, UW, integer					Error	Zero	Carry	Borrow	Step
		The number of S2 data address and saved address to execute the operation with S1 In the range within the corresponding device area of S2 and D									

<Ladder>

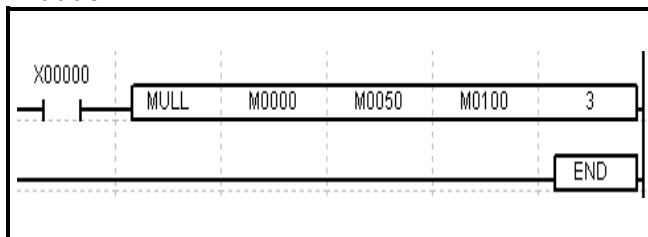

1. Multiplies the word value of S1 and the number of N word values, which are from S2 to S2(N-1), respectively, and then stores the result into the number of corresponding destination double words beginning with double word D.
2. Executes the Signed operation.
3. Any one of the results is '0', zero flag occurs.

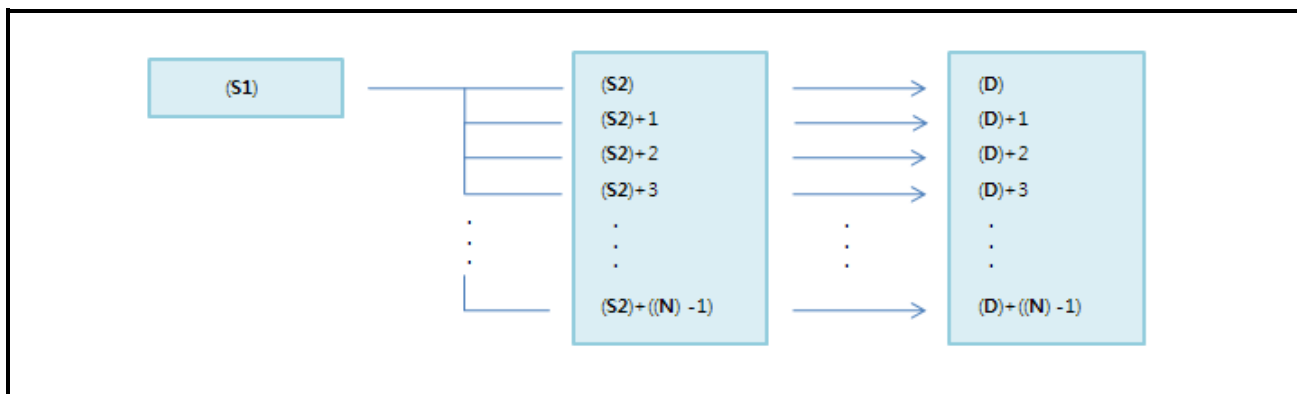
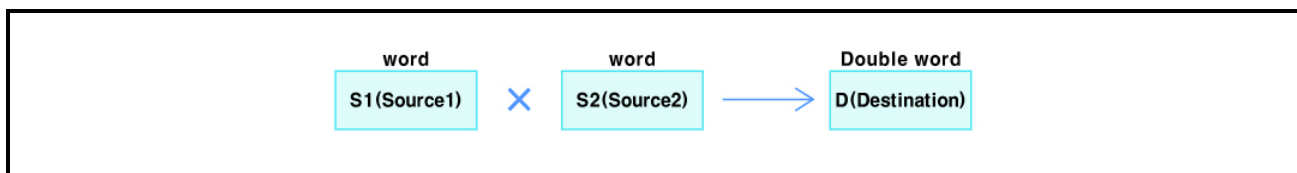

3.2.131 Arithmetic operation instruction(DMULL)

Arithmetic operation instruction			DMULL	S1	S2	D	N	Applicable model LP-S044, LP-S070				
OP	DATA type	Available device / Description / Range						Error	Zero	Carry	Borrow	Step
S1	DINT	X, Y, F, Z, T, C, M, S, L, D, UW, integer						<input type="checkbox"/>	<input checked="" type="radio"/>	<input checked="" type="radio"/>	<input type="checkbox"/>	9
		Data address to execute the multiplication with S2 -2147483648(h80000000) to 2147483647(h7FFFFFFF)										
S2	DINT	X, Y, F, Z, T, C, M, S, L, D, UW						<input type="checkbox"/>	<input type="checkbox"/>	<input type="checkbox"/>	<input type="checkbox"/>	
		Data address to execute the multiplication with S1 -2147483648(h80000000) to 2147483647(h7FFFFFFF)										
D	QINT	Y, F, Z, T, C, M, S, L, D, UW						<input type="checkbox"/>	<input type="checkbox"/>	<input type="checkbox"/>	<input type="checkbox"/>	
		Address to save the operation result										
N	WORD	X, Y, F, Z, T, C, M, S, L, D, UW, integer						<input type="checkbox"/>	<input type="checkbox"/>	<input type="checkbox"/>	<input type="checkbox"/>	
		The number of S2 data address and saved address to execute the operation with S1										
		In the range within the corresponding device area of S2 and D										

<Ladder>

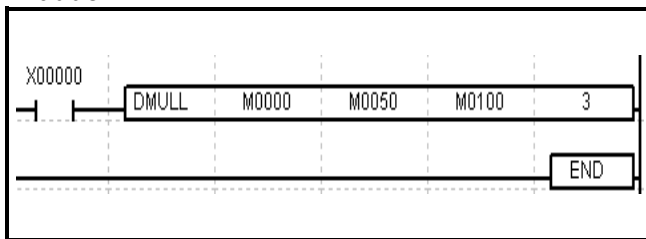

1. Multiplies the double word value of S1 and the number of N double word values, which are from S2 to S2(N-1), respectively, and then stores the result into the number of corresponding destination quad words beginning with D.
2. Executes the Signed operation.
3. Any one of the results is '0', zero flag occurs.

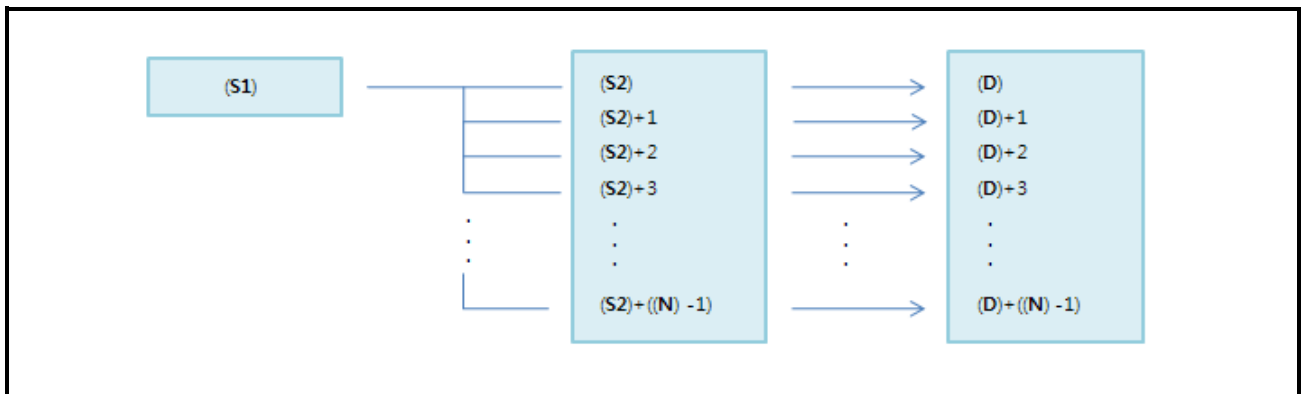
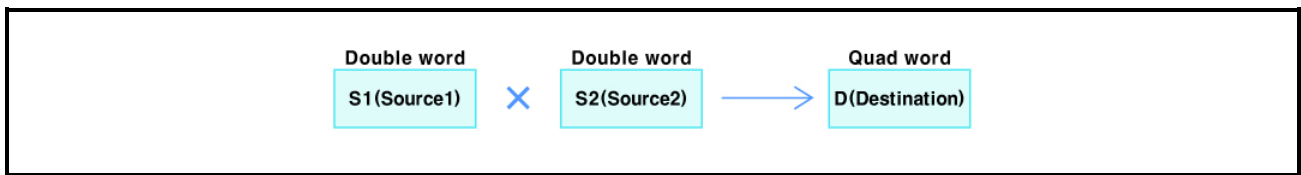

### 3.2.132 Arithmetic operation instruction(MULLU)

Arithmetic operation instruction			MULLU	S1	S2	D	N	Applicable model				
								LP-S044, LP-S070				
OP	DATA type	Available device / Description / Range						Error	Zero	Carry	Borrow	Step
S1	WORD	X, Y, F, Z, T, C, M, S, L, D, UW, integer						<input type="checkbox"/>	<input checked="" type="checkbox"/>	<input checked="" type="checkbox"/>	<input type="checkbox"/>	6
		Data address to execute the multiplication with S2										
		0(h0000) to 65535(hFFFF)										
S2	WORD	X, Y, F, Z, T, C, M, S, L, D, UW						<input type="checkbox"/>	<input checked="" type="checkbox"/>	<input checked="" type="checkbox"/>	<input type="checkbox"/>	6
		Data address to execute the multiplication with S1										
		0(h0000) to 65535(hFFFF)										
D	DWORD	Y, F, Z, T, C, M, S, L, D, UW						<input type="checkbox"/>	<input type="checkbox"/>	<input type="checkbox"/>	<input type="checkbox"/>	6
		Address to save the operation result										
		0(h0000) to 4294967295(hFFFFFFFF)										
N	WORD	X, Y, F, Z, T, C, M, S, L, D, UW, integer						<input type="checkbox"/>	<input type="checkbox"/>	<input type="checkbox"/>	<input type="checkbox"/>	6
		The number of S2 data address and saved address to execute the operation with S1										
		In the range within the corresponding device area of S2 and D										

<Ladder>

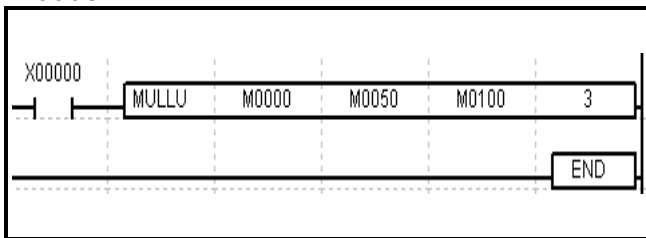

1. Multiplies the word value of S1 and the number of N word values, which are from S2 to S2(N-1) respectively, and then stores the result into the number of corresponding destination double words beginning with double word D one by one.
2. Executes the Unsigned operation.
3. Any one of the results is '0', zero flag occurs.

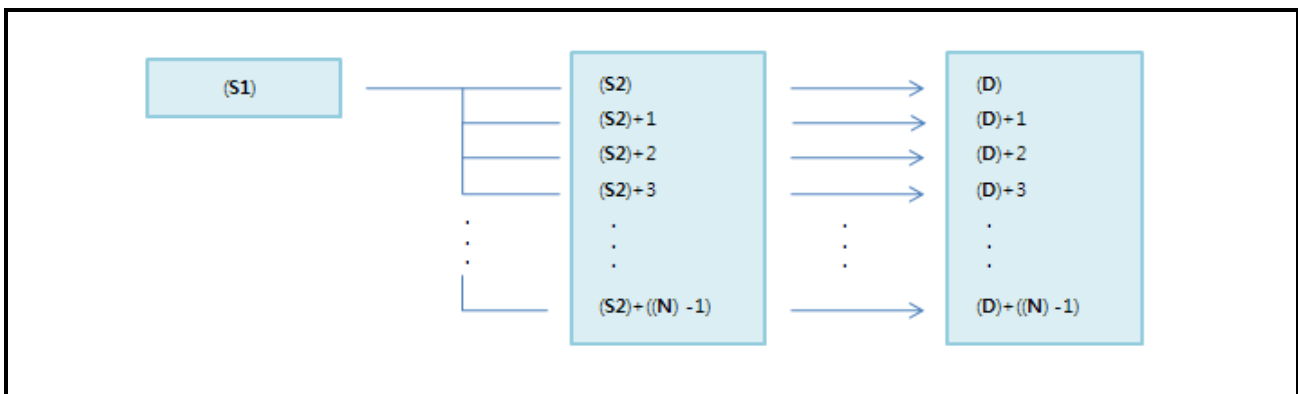
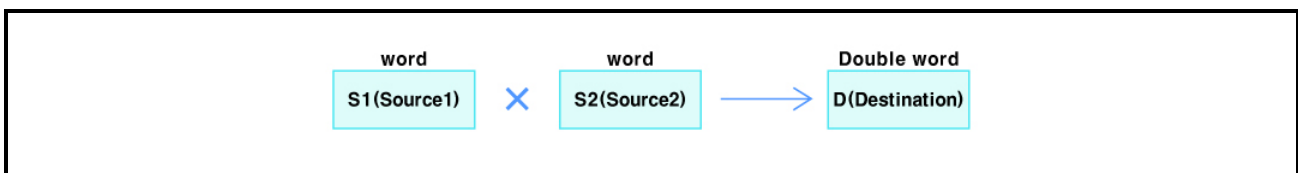

### 3.2.133 Arithmetic operation instruction(DMULLU)

Arithmetic operation instruction			DMULLU	S1	S2	D	N	Applicable model				
								LP-S044, LP-S070				
OP	DATA type	Available device / Description / Range						Error	Zero	Carry	Borrow	Step
S1	DWORD	X, Y, F, Z, T, C, M, S, L, D, UW, integer						<input type="checkbox"/>	<input checked="" type="checkbox"/>	<input checked="" type="checkbox"/>	<input type="checkbox"/>	9
		Data address to execute the multiplication with S2										
		0(h0000) to 4294967295(hFFFFFFF)										
S2	DWORD	X, Y, F, Z, T, C, M, S, L, D, UW						<input type="checkbox"/>	<input checked="" type="checkbox"/>	<input checked="" type="checkbox"/>	<input type="checkbox"/>	9
		Data address to execute the multiplication with S1										
		0(h0000) to 4294967295(hFFFFFFF)										
D	QWORD	Y, F, Z, T, C, M, S, L, D, UW						<input type="checkbox"/>	<input type="checkbox"/>	<input type="checkbox"/>	<input type="checkbox"/>	9
Address to save the operation result												
N	WORD	X, Y, F, Z, T, C, M, S, L, D, UW, integer						<input type="checkbox"/>	<input type="checkbox"/>	<input type="checkbox"/>	<input type="checkbox"/>	9
		The number of S2 data address and saved address to execute the operation with S1										
		In the range within the corresponding device area of S2 and D										

<Ladder>

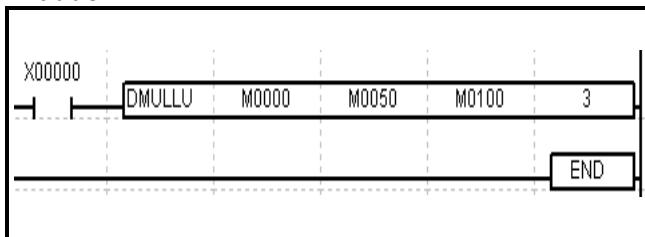

1. Multiplies the double word value of S1 and the number of N double word values, which are from S2 to S2(N-1), and then stores the result into the number of N corresponding destination quad words beginning with quad word D one by one.
2. Executes the Unsigned operation.
3. Any one of the results is '0', zero flag occurs.

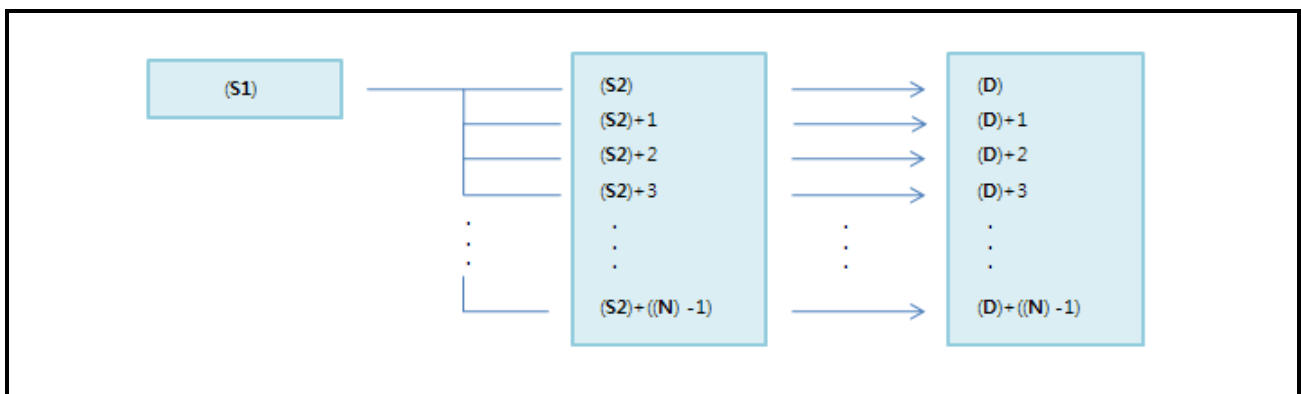
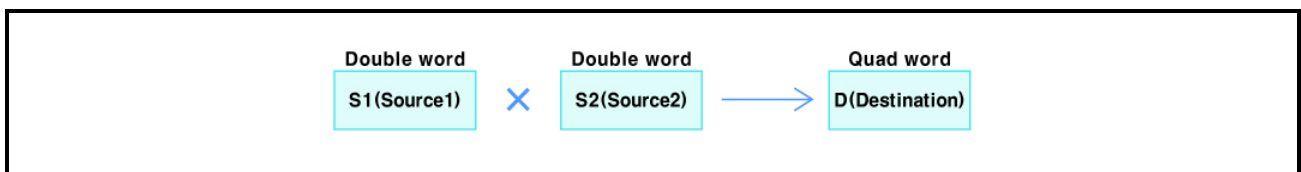

### 3.2.134 Arithmetic operation instruction(DIV)

<b>Arithmetic operation instruction</b>		<b>DIV</b>	<b>S1</b>	<b>S2</b>	<b>D</b>	Applicable model LP-S044, LP-S070				
OP	DATA type	Available device / Description / Range				Error	Zero	Carry	Borrow	Step
<b>S1</b>	INT	X, Y, F, Z, T, C, M, S, L, D, UW, integer				☉	☉			7
		Data address to execute the division operation with S2 -32768(h8000) to 32767(h7FFF)								
<b>S2</b>	INT	X, Y, F, Z, T, C, M, S, L, D, UW, integer								
		Data address to execute the division operation with S1 -32768(h8000) to 32767(h7FFF)								
<b>D</b>	INT	Y, F, Z, T, C, M, S, L, D, UW								
		Address to save the operation result -32768(h8000) to 32767(h7FFF)								

<Ladder>

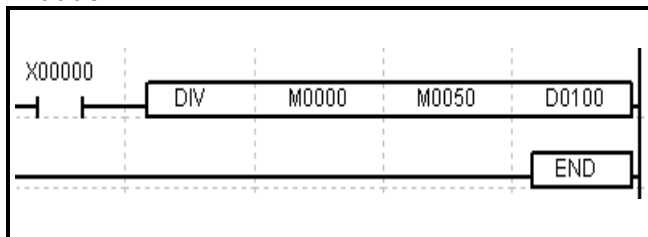

1. Divides the word value of S1 by that of S2 and then stores the quotient and the remainder into the destination "Word D" and "Word D+1" respectively.
2. Executes the Signed operation.
3. If the divisor is 0, error flag is SET.
4. If the dividend is 0, zero flag is SET.

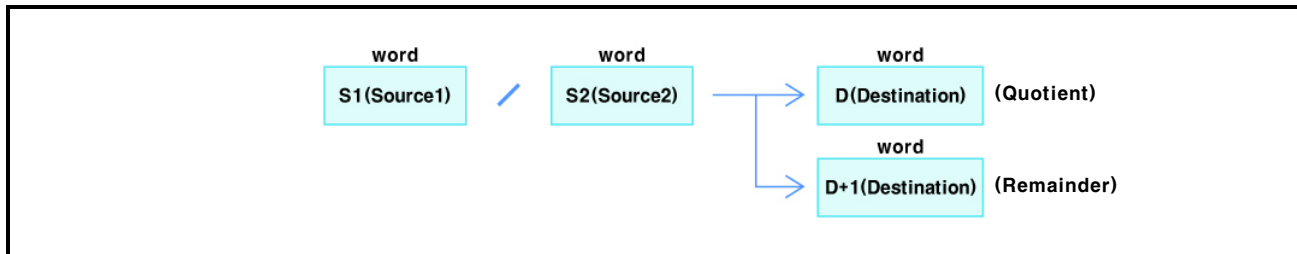



### 3.2.135 Arithmetic operation instruction(DDIV)

Arithmetic operation instruction			DDIV	S1	S2	D	Applicable model LP-S044, LP-S070				
OP	DATA type	Available device / Description / Range					Error	Zero	Carry	Borrow	Step
S1	DINT	X, Y, F, Z, T, C, M, S, L, D, UW, integer					☉	☉			7
		Data address to execute the division operation with S2 -2147483648(h80000000) to 2147483647(hFFFFFFF)									
S2	DINT	X, Y, F, Z, T, C, M, S, L, D, UW, integer									
		Data address to execute the division operation with S1 -2147483648(h80000000) to 2147483647(hFFFFFFF)									
D	DINT	Y, F, Z, T, C, M, S, L, D, UW									
		Address to save the operation result -2147483648(h80000000) to 2147483647(hFFFFFFF)									

<Ladder>

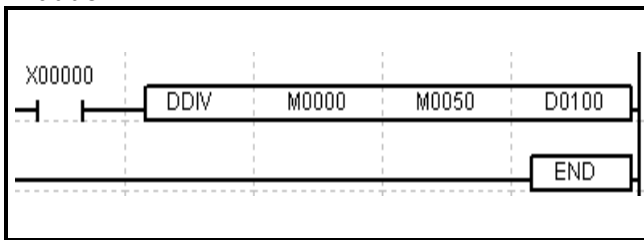

1. Divides the double word value of S1 by that of S2 and then stores the quotient and the remainder into the destination "Double Word D" and "Double Word D+1" respectively.
2. Executes the Signed operation.
3. If the divisor is 0, error flag is SET.
4. If the dividend is 0, zero flag is SET.

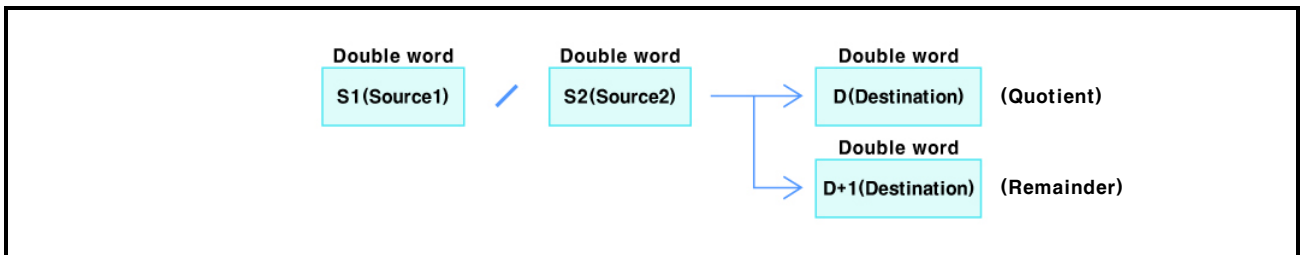

### 3.2.136 Arithmetic operation instruction(DIVU)

<b>Arithmetic operation instruction</b>		<b>DIVU</b>	<b>S1</b>	<b>S2</b>	<b>D</b>	Applicable model LP-S044, LP-S070				
OP	DATA type	Available device / Description / Range				Error	Zero	Carry	Borrow	Step
<b>S1</b>	WORD	X, Y, F, Z, T, C, M, S, L, D, UW, integer				<input checked="" type="checkbox"/>	<input checked="" type="checkbox"/>	<input type="checkbox"/>	<input type="checkbox"/>	7
		Data address to execute the division operation with S2 0(h0000) to 65535(hFFFF)								
<b>S2</b>	WORD	X, Y, F, Z, T, C, M, S, L, D, UW, integer								
		Data address to execute the division operation with S1 0(h0000) to 65535(hFFFF)								
<b>D</b>	WORD	Y, F, Z, T, C, M, S, L, D, UW								
		Address to save the operation result 0(h0000) to 65535(hFFFF)								

<Ladder>

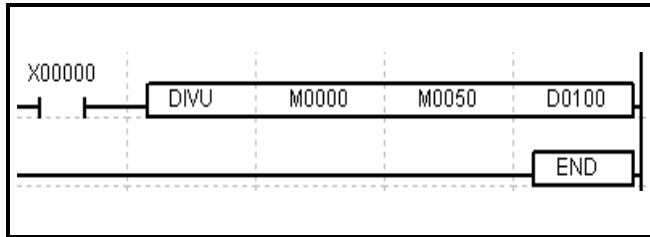

1. Divides the word value of S1 by that of S2 and then stores the quotient and the remainder into the destination "Word D" and "Word D+1" respectively.
2. Executes the Unsigned operation.
3. If the divisor is 0, error flag is SET.
4. If the dividend is 0, zero flag is SET.

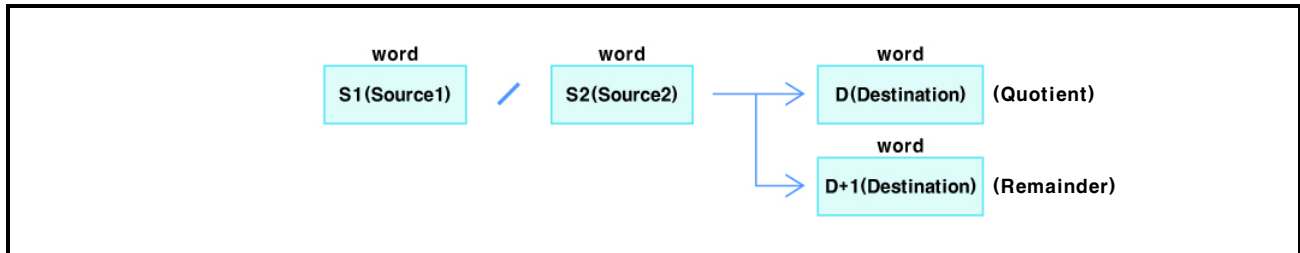

**3.2.137 Arithmetic operation instruction(DDIVU)**

<b>Arithmetic operation instruction</b>			<b>DDIVU</b>	<b>S1</b>	<b>S2</b>	<b>D</b>	Applicable model LP-S044, LP-S070				
OP	DATA type	Available device / Description / Range					Error	Zero	Carry	Borrow	Step
S1	DWORD	X, Y, F, Z, T, C, M, S, L, D, UW, integer					☉	☉			7
		Data address to execute the division operation with S2 0(h0000) to 4294967295(hFFFFFFFF)									
S2	DWORD	X, Y, F, Z, T, C, M, S, L, D, UW, integer									
		Data address to execute the division operation with S1 0(h0000) to 4294967295(hFFFFFFFF)									
D	DWORD	Y, F, Z, T, C, M, S, L, D, UW									
		Address to save the operation result 0(h0000) to 4294967295(hFFFFFFFF)									

<Ladder>

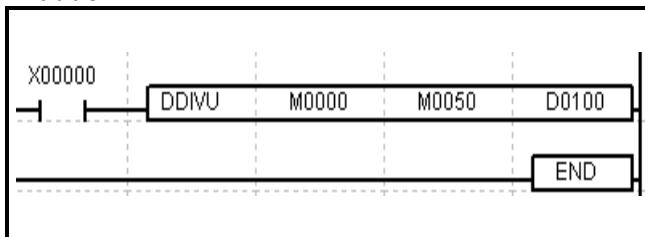

1. Divides the double word value of S1 by that of S2 and then stores the quotient and the remainder into the destination "Double Word D" and "Double Word D+1" respectively.
2. Executes the Unsigned operation.
3. If the divisor is 0, error flag is SET.
4. If the dividend is 0, zero flag is SET.

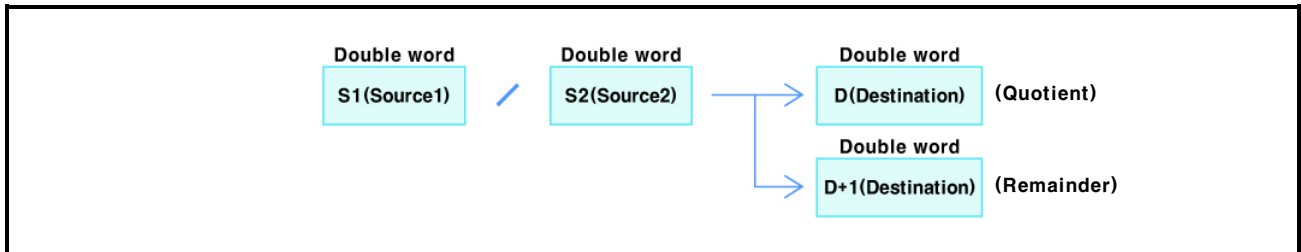

### 3.2.138 Arithmetic operation instruction(DIVL)

Arithmetic operation instruction		DIVL	S1	S2	D	N	Applicable model				
							LP-S044, LP-S070				
OP	DATA type	Available device / Description / Range					Error	Zero	Carry	Borrow	Step
S1	INT	X, Y, F, Z, T, C, M, S, L, D, UW, integer					☉	☉			6
		Data address to execute the division operation with S2 -32768(h8000) to 32767(h7FFF)									
S2	INT	X, Y, F, Z, T, C, M, S, L, D, UW									
		Data address to execute the division operation with S1 -32768(h8000) to 32767(h7FFF)									
D	INT	Y, F, Z, T, C, M, S, L, D, UW									
		Address to save the operation result -32768(h8000) to 32767(h7FFF)									
N	WORD	X, Y, F, Z, T, C, M, S, L, D, UW, integer									
		The number of S2 data address and saved address to execute the operation with S1 In the range within the corresponding device area of S2 and D									

<Ladder>

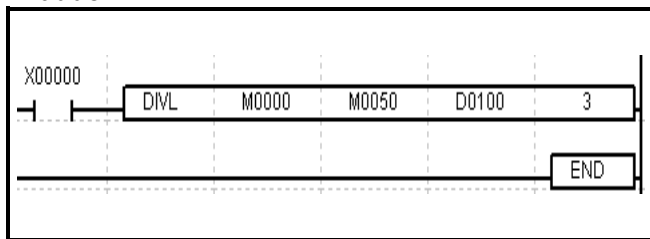

1. Divides the word value of S1 by the number of N word values beginning with S2 and then stores the quotient and the remainder into the destination "Word D" and "Word D+1" respectively.
2. Executes the Signed operation.
3. If the divisor is 0, error flag is SET.
4. If the dividend is 0, zero flag is SET.

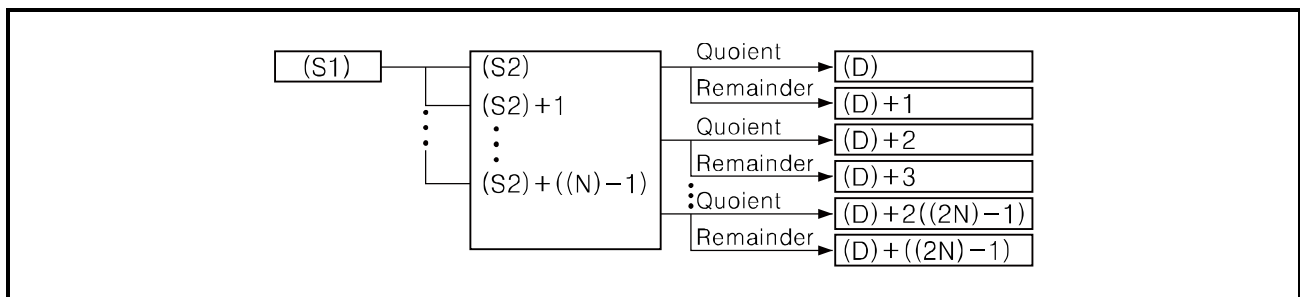
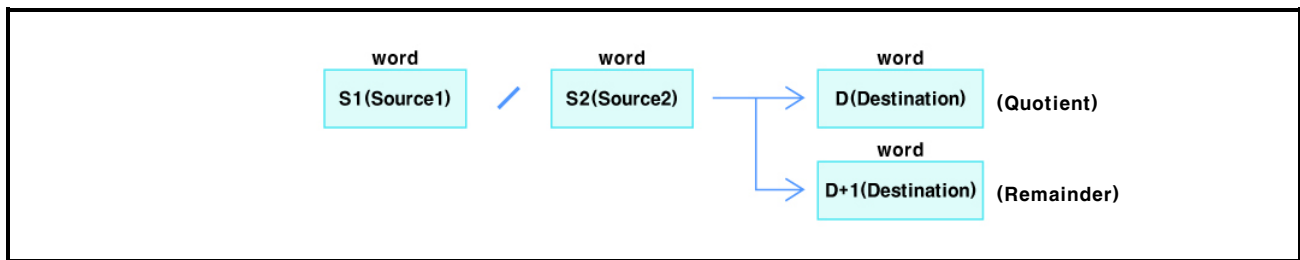

3.2.139 Arithmetic operation instruction(DDIVL)

Arithmetic operation instruction			DDIVL	S1	S2	D	N	Applicable model LP-S044, LP-S070				
OP	DATA type	Available device / Description / Range						Error	Zero	Carry	Borrow	Step
S1	DINT	X, Y, F, Z, T, C, M, S, L, D, UW, integer						☉	☉			9
		Data address to execute the division operation with S2 -2147483648(h80000000) to 2147483647(hFFFFFFF)										
S2	DINT	X, Y, F, Z, T, C, M, S, L, D, UW										
		Data address to execute the division operation with S1 -2147483648(h80000000) to 2147483647(hFFFFFFF)										
D	DINT	Y, F, Z, T, C, M, S, L, D, UW										
		Address to save the operation result -2147483648(h80000000) to 2147483647(hFFFFFFF)										
N	WORD	X, Y, F, Z, T, C, M, S, L, D, UW, integer										
		The number of S2 data address and saved address to execute the operation with S1 In the range within the corresponding device area of S2 and D										

<Ladder>

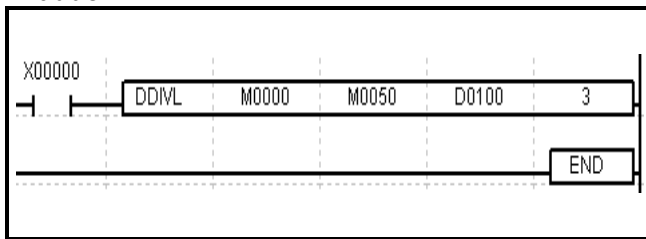

1. Divides the double word value of S1 by the number of N double word values beginning with S2 and then stores the quotient and the remainder into the destination "Double Word D" and "Double Word D+1" respectively.
2. Executes the Signed operation.
3. If the divisor is 0, error flag is SET.
4. If the dividend is 0, zero flag is SET.

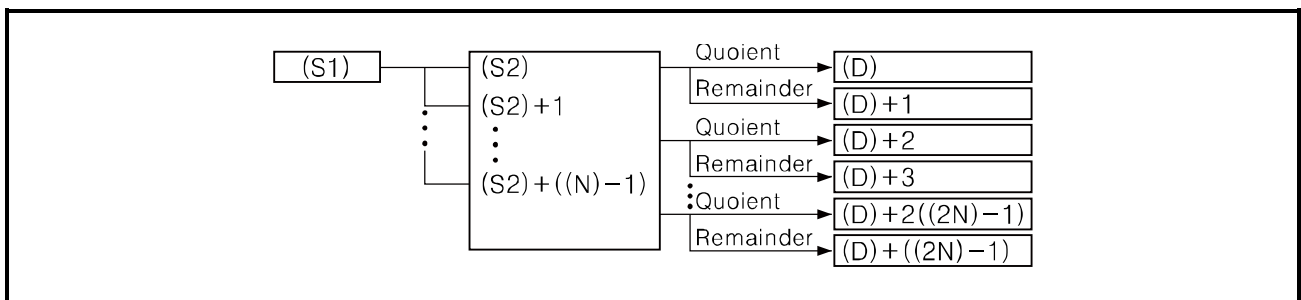
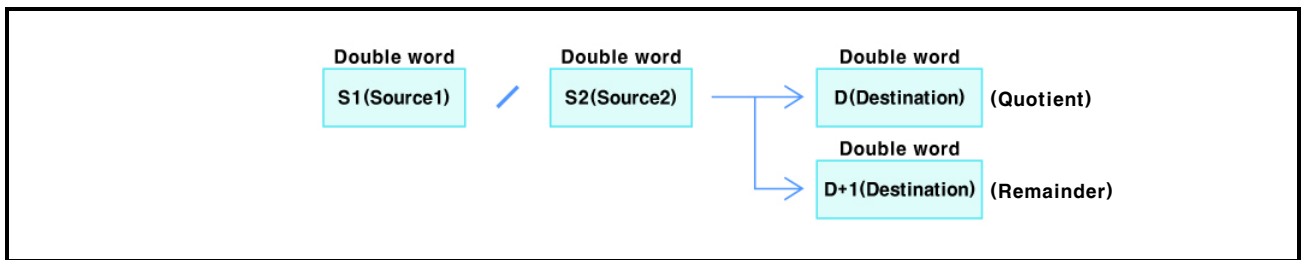

### 3.2.140 Arithmetic operation instruction(DIVLU)

Arithmetic operation instruction		DIVLU	S1	S2	D	N	Applicable model				
							LP-S044, LP-S070				
OP	DATA type	Available device / Description / Range					Error	Zero	Carry	Borrow	Step
S1	WORD	X, Y, F, Z, T, C, M, S, L, D, UW, integer					☉	☉			6
		Data address to execute the division operation with S2 0(h0000) to 65535(hFFFF)									
S2	WORD	X, Y, F, Z, T, C, M, S, L, D, UW									
		Data address to execute the division operation with S1 0(h0000) to 65535(hFFFF)									
D	WORD	Y, F, Z, T, C, M, S, L, D, UW									
		Address to save the operation result 0(h0000) to 65535(hFFFF)									
N	WORD	X, Y, F, Z, T, C, M, S, L, D, UW, integer									
		The number of S2 data address and saved address to execute the operation with S1 In the range within the corresponding device area of S2 and D									

<Ladder>

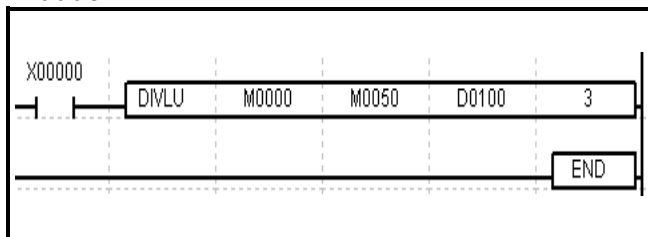

1. Divides the word value of S1 by the number of N word values beginning with S2 and then stores the quotient and the remainder into the destination "Word D" and "Word D+1" respectively.
2. Executes the Unsigned operation.
3. If the divisor is 0, error flag is SET.
4. If the dividend is 0, zero flag is SET.

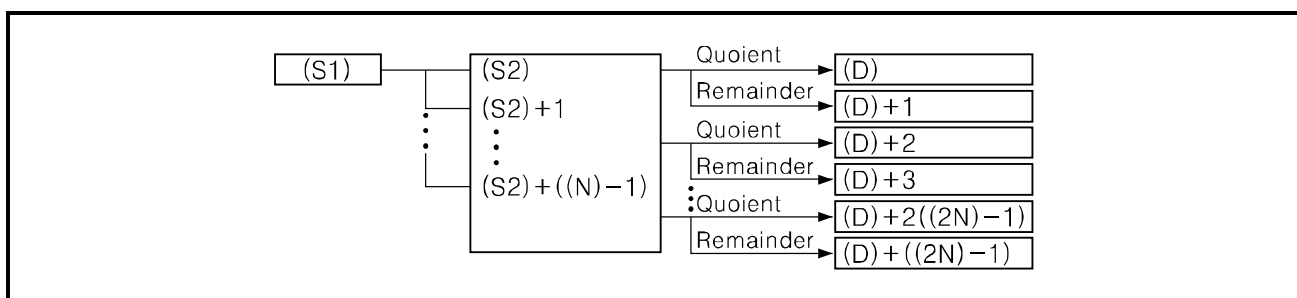
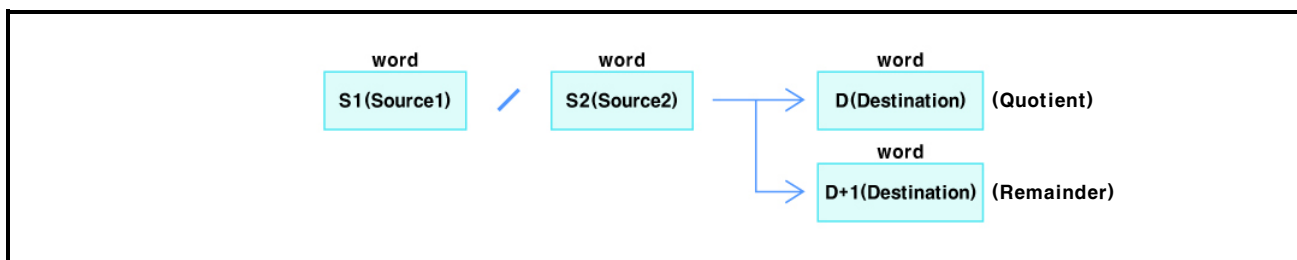

### 3.2.141 Arithmetic operation instruction(DDIVLU)

Arithmetic operation instruction			DDIVLU	S1	S2	D	N	Applicable model				
								LP-S044, LP-S070				
OP	DATA type	Available device / Description / Range						Error	Zero	Carry	Borrow	Step
S1	DWORD	X, Y, F, Z, T, C, M, S, L, D, UW, integer						☉	☉			9
		Data address to execute the division operation with S2 0(h0000) to 4294967295(hFFFFFFF)										
S2	DWORD	X, Y, F, Z, T, C, M, S, L, D, UW										
		Data address to execute the division operation with S1 0(h0000) to 4294967295(hFFFFFFF)										
D	DWORD	Y, F, Z, T, C, M, S, L, D, UW										
		Address to save the operation result 0(h0000) to 4294967295(hFFFFFFF)										
N	WORD	X, Y, F, Z, T, C, M, S, L, D, UW, integer										
		The number of S2 data address and saved address to execute the operation with S1 In the range within the corresponding device area of S2 and D										

<Ladder>

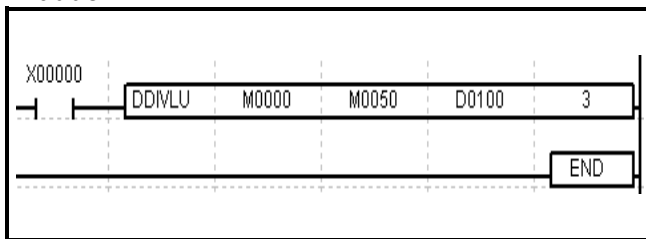

1. Divides the double word value of S1 by the number of N double word values beginning with S2 and then stores the quotient and the remainder into the destination "Double Word D" and "Double Word D+1" respectively.
2. Executes the Unsigned operation.
3. If the divisor is 0, error flag is SET.
4. If the dividend is 0, zero flag is SET.

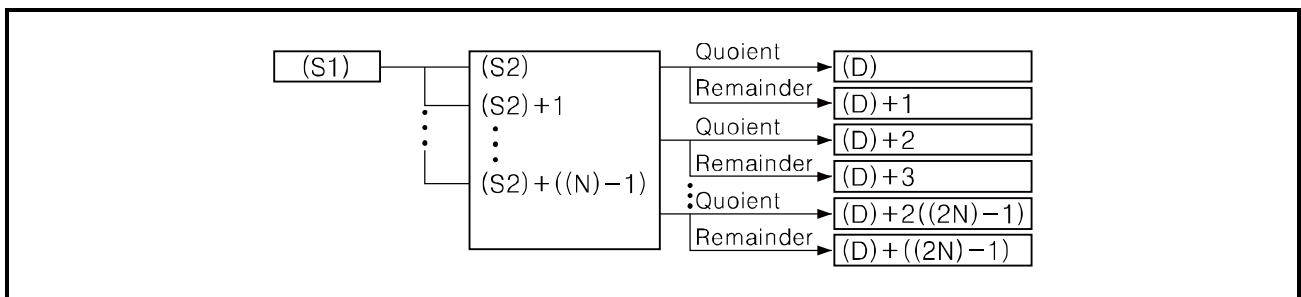
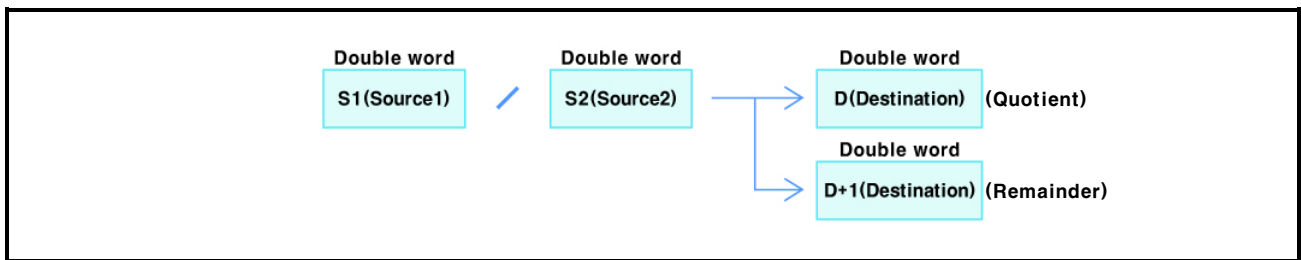

### 3.2.142 Arithmetic operation instruction(INC)

<b>Arithmetic operation instruction</b>		<b>INC</b>	<b>D</b>	Applicable model					
					LP-S044, LP-S070				
OP	DATA type	Available device / Description / Range			Error	Zero	Carry	Borrow	Step
<b>D</b>	WORD	Y, F, Z, T, C, M, S, L, D, UW				⊙	⊙		3
		Data address to execute the operation							
		0(h0000) to 65535(hFFFF)							

<Ladder>

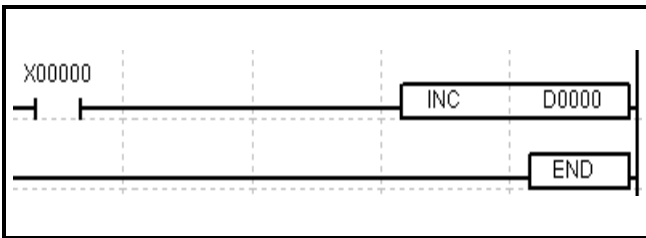

1. Increases the value of destination word D by '1'.
2. If the value is increased from the maximum value by 1 and then becomes 0, zero flag and carry flag are SET.

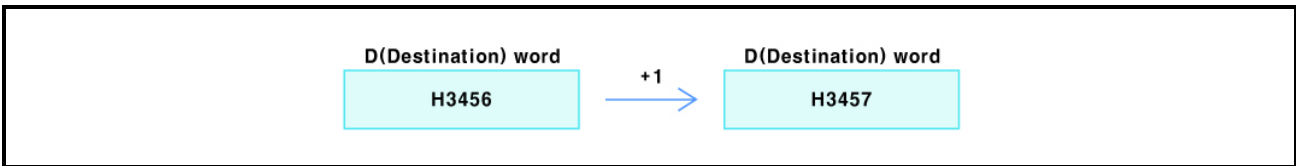



### 3.2.143 Arithmetic operation instruction(DINC)

Arithmetic operation instruction			DINC	D	Applicable model LP-S044, LP-S070				
OP	DATA type	Available device / Description / Range			Error	Zero	Carry	Borrow	Step
D	DWORD	Y, F, Z, T, C, M, S, L, D, UW				⊙	⊙		3
		Data address to execute the operation							
		0(h0000) to 4294967295(hFFFFFFF)							

<Ladder>

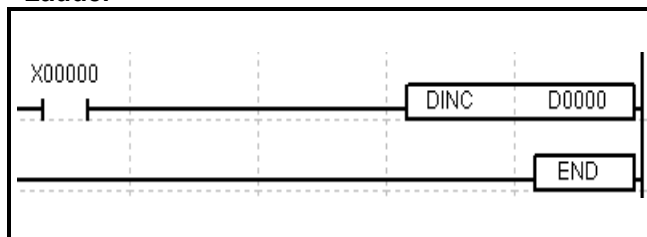

1. Increases the value of destination double word D by '1'.
2. If the value is increased from the maximum value by 1 and then D value becomes 0, zero flag and carry flag are SET.

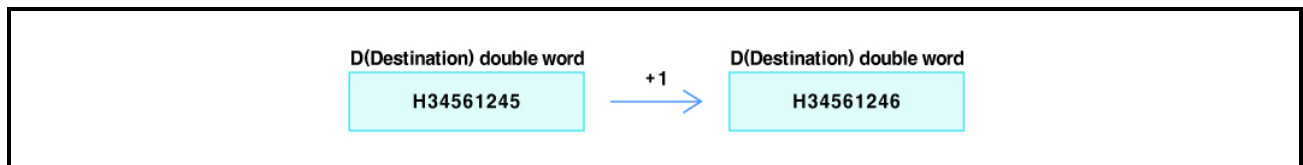

### 3.2.144 Arithmetic operation instruction(DEC)

<b>Arithmetic operation instruction</b>		<b>DEC</b>	<b>D</b>	Applicable model LP-S044, LP-S070					
OP	DATA type	Available device / Description / Range			Error	Zero	Carry	Borrow	Step
<b>D</b>	WORD	Y, F, Z, T, C, M, S, L, D, UW				⊙		⊙	3
		Data address to execute the operation							
		0(h0000) to 65535(hFFFF)							

<Ladder>

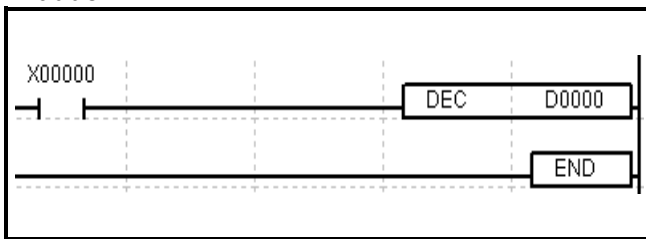

1. Decreases the value of destination word D by '1'.
2. If D value is '0', zero flag is SET.
3. If D value is decreased again from '0', borrow flag is SET.

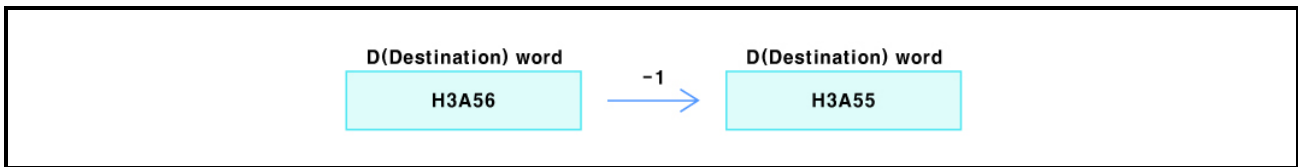

### 3.2.145 Arithmetic operation instruction(DDEC)

Arithmetic operation Instruction		DDEC	D	Applicable model LP-S044, LP-S070					
OP	DATA type	Available device / Description / Range			Error	Zero	Carry	Borrow	Step
D	DWORD	Y, F, Z, T, C, M, S, L, D, UW				⊙		⊙	3
		Data address to execute the operation							
		0(h0000) to 4294967295(hFFFFFFF)							

<Ladder>

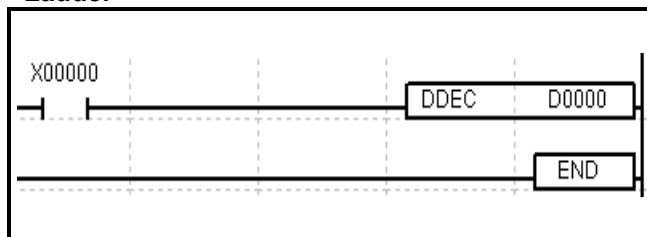

1. Decreases the value of destination double word D by '1'.
2. If D value is '0', zero flag is SET.
3. If D value is decreased again from '0', carry flag is SET.

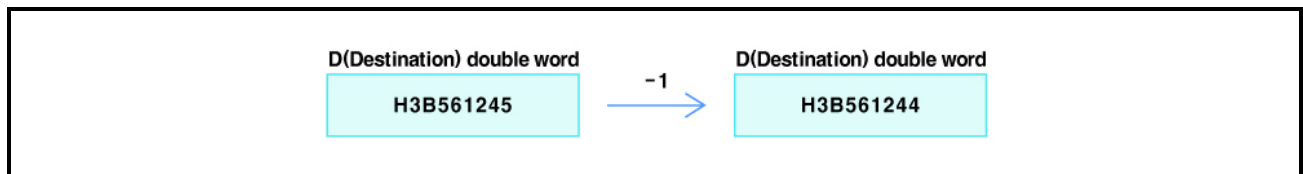

### 3.2.146 Arithmetic operation instruction(ADDB)

Arithmetic operation instruction			ADDB	S1	S2	D	Applicable model				
							LP-S044, LP-S070				
OP	DATA type	Available device / Description / Range					Error	Zero	Carry	Borrow	Step
S1	WORD	X, Y, F, Z, T, C, M, S, L, D, UW, integer					☉	☉	☉		7
		Data address to execute the BCD addition operation with S2 h0000 to h9999									
S2	WORD	X, Y, F, Z, T, C, M, S, L, D, UW, integer									
		Data address to execute the BCD addition operation with S1 h0000 to h9999									
D	WORD	Y, F, Z, T, C, M, S, L, D, UW									
		Address to save the operation result h0000 to h9999									

<Ladder>

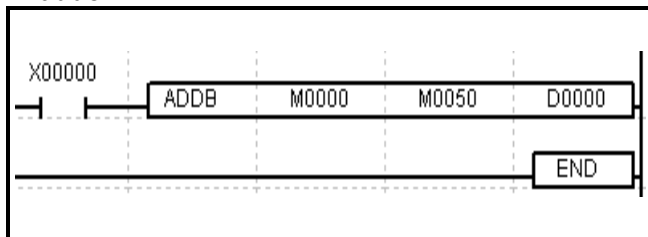

1. Adds the word value of S1 and that of S2, both are composed of BCD codes, and then stores the result into the destination word D as BCD code.
2. If any of the value not composed of the BCD code is detected in S1 and S2, error flag is SET. (Except 0 to 9999)
3. If the result value is out of the range of D, carry flag is SET.
4. If the result value is '0', zero flag is SET.

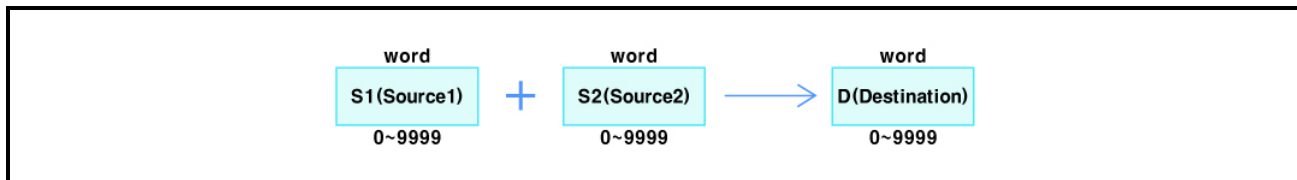

**3.2.147 Arithmetic operation instruction(DADDB)**

Arithmetic operation instruction			DADDB	S1	S2	D	Applicable model LP-S044, LP-S070				
OP	DATA type	Available device / Description / Range					Error	Zero	Carry	Borrow	Step
S1	DWORD	X, Y, F, Z, T, C, M, S, L, D, UW, integer					☉	☉	☉		7
		Data address to execute the BCD addition operation with S2									
		h00000000 to h99999999									
S2	DWORD	X, Y, F, Z, T, C, M, S, L, D, UW, integer									
		Data address to execute the BCD addition operation with S1									
		h00000000 to h99999999									
D	DWORD	Y, F, Z, T, C, M, S, L, D, UW									
		Address to save the operation result									
		h00000000 to h99999999									

<Ladder>

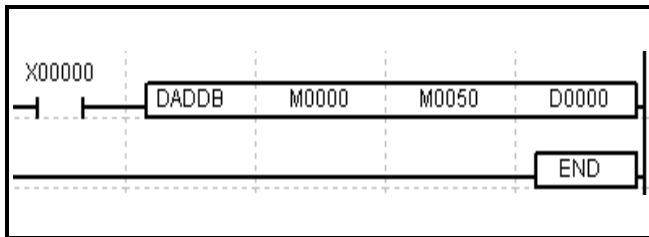

1. Adds the double word values of S1 and S2, both are composed of BCD codes, and then stores the result into the destination double word D as BCD codes.
2. If any of the value not composed of the BCD code is detected in S1 and S2, error flag is SET.  
(Except 0 to 99999999)
3. If the result value is out of the range of D, carry flag is SET.
4. If the result value is '0', zero flag is SET.

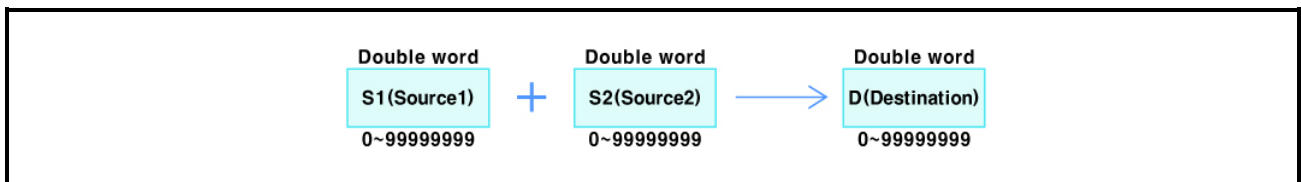

### 3.2.148 Arithmetic operation instruction(ADDBL)

Arithmetic operation instruction		ADDBL	S1	S2	D	N	Applicable model				
							LP-S044, LP-S070				
OP	DATA type	Available device / Description / Range					Error	Zero	Carry	Borrow	Step
S1	WORD	X, Y, F, Z, T, C, M, S, L, D, UW, integer					⊙	⊙	⊙		9
		Data address to execute the BCD addition operation with S2									
		h0000 to h9999									
S2	WORD	X, Y, F, Z, T, C, M, S, L, D, UW									
		Data address to execute the BCD addition operation with S1									
		h0000 to h9999									
D	WORD	Y, F, Z, T, C, M, S, L, D, UW									
		Address to save the operation result									
		h0000 to h9999									
N	WORD	X, Y, F, Z, T, C, M, S, L, D, UW, integer									
		The number of S2 data address and saved address to execute the operation with S1									
		In the range within the corresponding device area of S2 and D									

<Ladder>

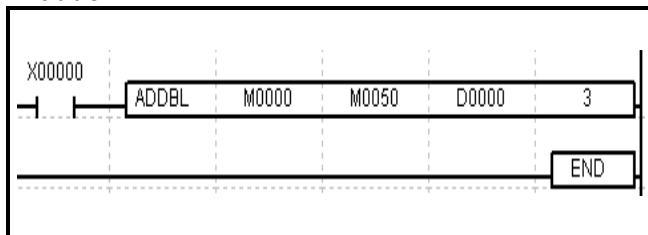

1. Adds the word value of S1 composed of BCD code and the number of N word values beginning with S2 also composed of BCD code, respectively, and then stores the result into the number of N destination words beginning with D as BCD code.
2. If any of the value not composed of the BCD code is detected in S1 and S2, error flag is SET.
3. If any of the result value from D to D+N is out of the D range, carry flag is SET.
4. If any of the result value from D to D+N is 0, zero flag is SET.

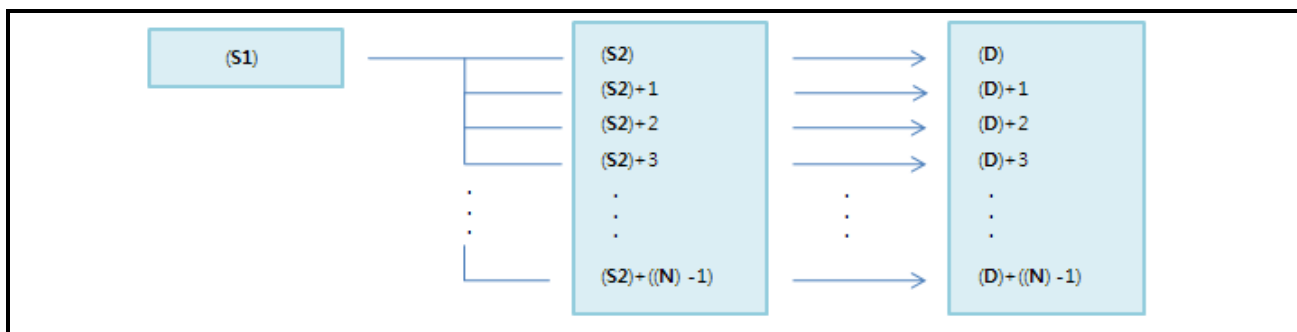
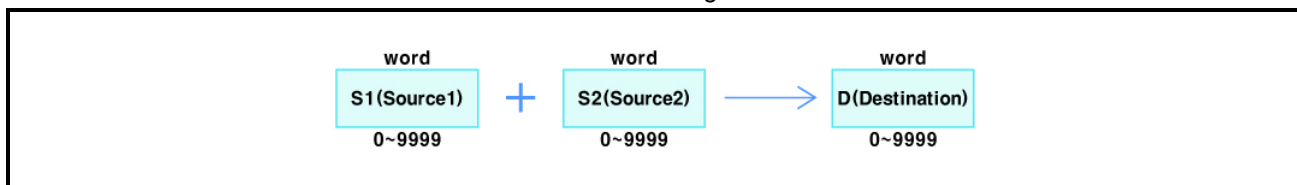

### 3.2.149 Arithmetic operation instruction(DADDBL)

Arithmetic operation instruction			DADDBL	S1	S2	D	N	Applicable model				
								LP-S044, LP-S070				
OP	DATA type	Available device / Description / Range						Error	Zero	Carry	Borrow	Step
S1	DWORD	X, Y, F, Z, T, C, M, S, L, D, UW, integer						⊙	⊙	⊙		9
		Data address to execute the BCD addition operation with S2 h00000000 to h99999999										
S2	DWORD	X, Y, F, Z, T, C, M, S, L, D, UW										
		Data address to execute the BCD addition operation with S1 h00000000 to h99999999										
D	DWORD	Y, F, Z, T, C, M, S, L, D, UW										
		Address to save the operation result h00000000 to h99999999										
N	WORD	X, Y, F, Z, T, C, M, S, L, D, UW, integer										
		The number of S2 data address and saved address to execute the operation with S1 In the range within the corresponding device area of S2 and D										

<Ladder>

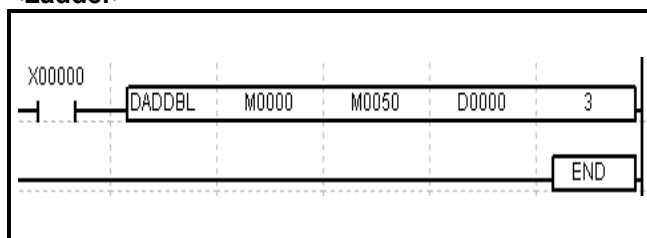

1. Adds the double word values S1 composed of BCD code and the number of N double word values beginning with S2 also composed of BCD code, respectively, and then stores the result into the number of N destination double words beginning with D double word as BCD code.
2. If any of the value not composed of the BCD code is detected in S1 and S2 error flag is SET.
3. If any of the result value from D and D+N is out of the D range, carry flag is SET.
4. If any of the result value from D and D+N is 0, zero flag is SET.

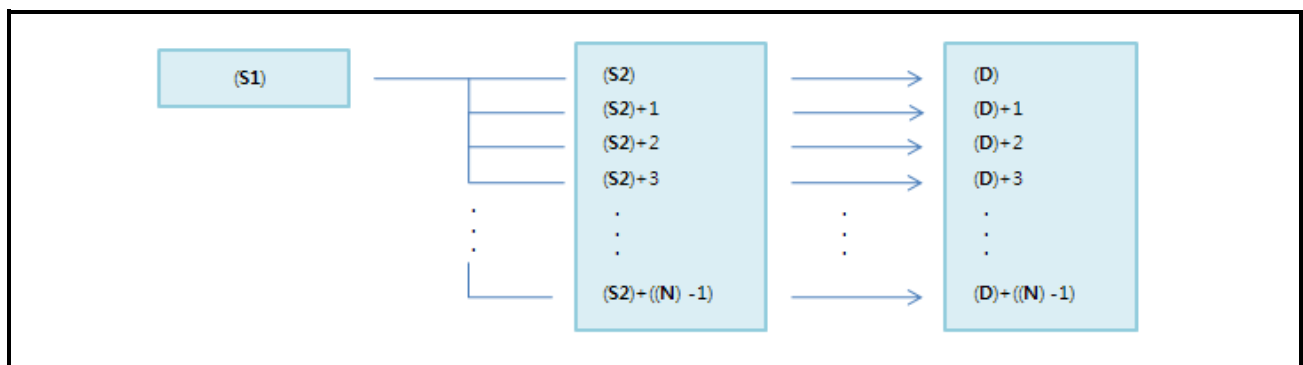
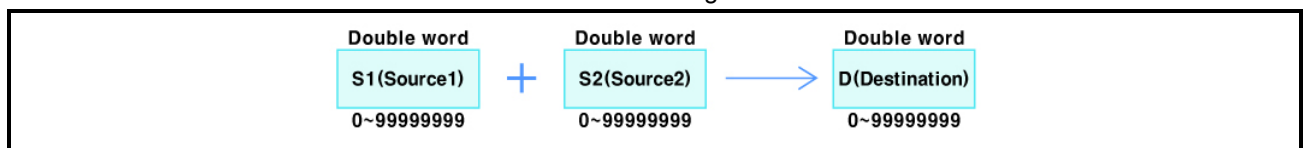

### 3.2.150 Arithmetic operation instruction(SUBB)

<b>Arithmetic operation instruction</b>		<b>SUBB</b>	<b>S1</b>	<b>S2</b>	<b>D</b>	Applicable model LP-S044, LP-S070				
OP	DATA type	Available device / Description / Range				Error	Zero	Carry	Borrow	Step
<b>S1</b>	WORD	X, Y, F, Z, T, C, M, S, L, D, UW, integer				☉	☉		☉	7
		Data address to execute the BCD subtraction operation with S2 h0000 to h9999								
<b>S2</b>	WORD	X, Y, F, Z, T, C, M, S, L, D, UW, integer								
		Data address to execute the BCD subtraction operation with S1 h0000 to h9999								
<b>D</b>	WORD	Y, F, Z, T, C, M, S, L, D, UW								
		Address to save the operation result h0000 to h9999								

<Ladder>

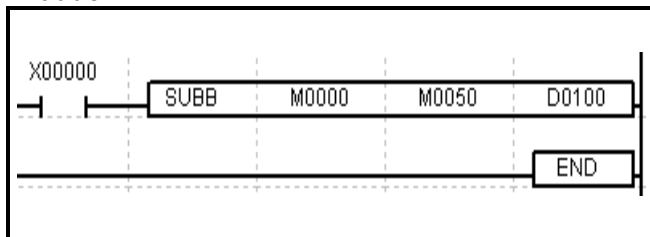

1. Subtracts the word value of S2 composed of BCD code from the word value of S1 composed of BCD code, and then stores the result into the destination word D as BCD code.
2. If any of the value not composed of the BCD code is detected in S1 and S2, error flag is SET. (Except 0 to 9999)
3. If the result value is negative number, it is stored as 'h9999'.
4. If the result value is '0', zero flag is SET.

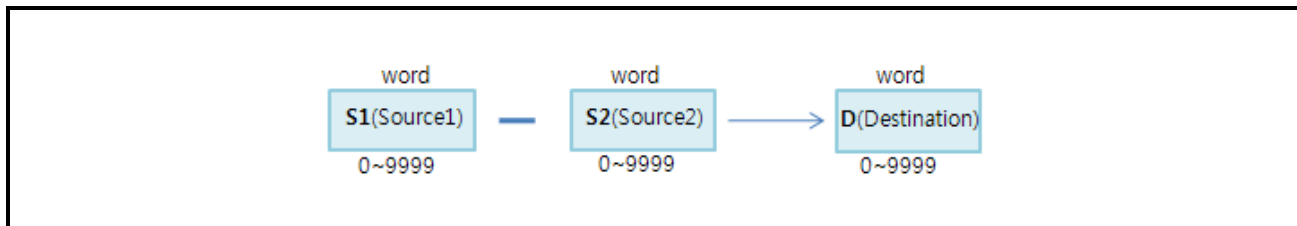



### 3.2.151 Arithmetic operation instruction(DSUBB)

Arithmetic operation instruction			DSUBB	S1	S2	D	Applicable model				
							LP-S044, LP-S070				
OP	DATA type	Available device / Description / Range					Error	Zero	Carry	Borrow	Step
S1	DWORD	X, Y, F, Z, T, C, M, S, L, D, UW, integer					☉	☉		☉	7
		Data address to execute the BCD subtraction operation with S2 h00000000 to h99999999									
S2	DWORD	X, Y, F, Z, T, C, M, S, L, D, UW, integer									
		Data address to execute the BCD subtraction operation with S1 h00000000 to h99999999									
D	DWORD	Y, F, Z, T, C, M, S, L, D, UW									
		Address to save the operation result h00000000 to h99999999									

<Ladder>

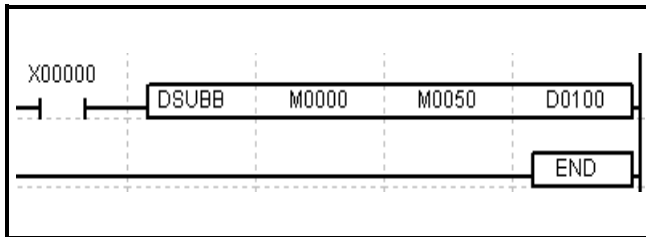

1. Subtracts the double word value of S2 from double word value of S1, both are composed of BCD code, and then stores the result into the destination double word D as BCD code.
2. If any of the value not composed of the BCD code is detected in S1 and S2, error flag is SET. (Except 0 to 99999999)
3. If the result value is negative number, it is stored as 'h9999'.
4. If the result value is '0', zero flag is SET.

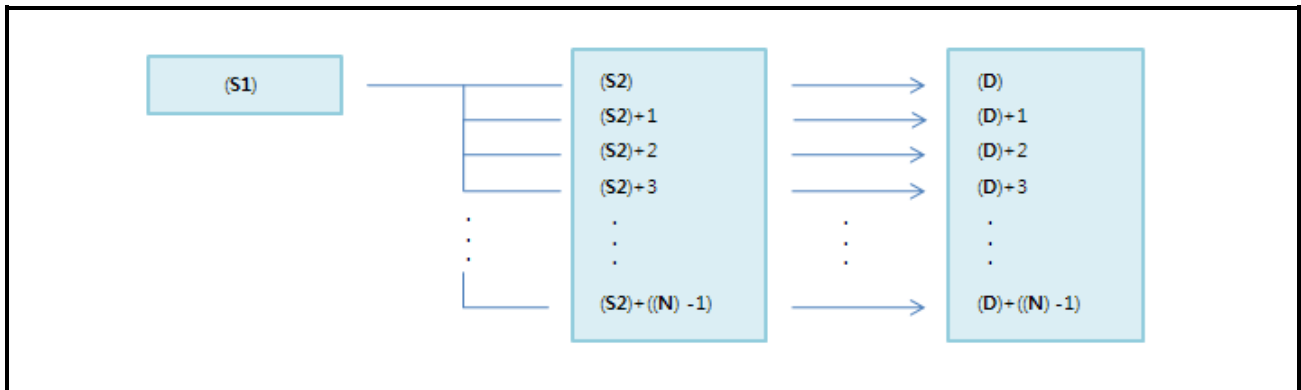
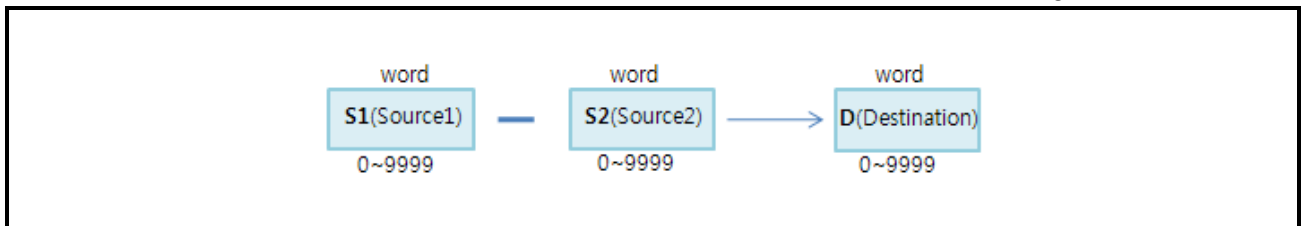

### 3.2.152 Arithmetic operation instruction(SUBBL)

Arithmetic operation instruction		SUBBL	S1	S2	D	N	Applicable model				
							LP-S044, LP-S070				
OP	DATA type	Available device / Description / Range					Error	Zero	Carry	Borrow	Step
S1	WORD	X, Y, F, Z, T, C, M, S, L, D, UW, integer					☉	☉		☉	9
		Data address to execute the BCD subtraction operation with S2 h0000 to h9999									
S2	WORD	X, Y, F, Z, T, C, M, S, L, D, UW									
		Data address to execute the BCD subtraction operation with S1 h0000 to h9999									
D	WORD	Y, F, Z, T, C, M, S, L, D, UW									
		Address to save the operation result h0000 to h9999									
N	WORD	X, Y, F, Z, T, C, M, S, L, D, UW, integer									
		The number of S2 data address and saved address to execute the operation with S1 In the range within the corresponding device area of S2 and D									

<Ladder>

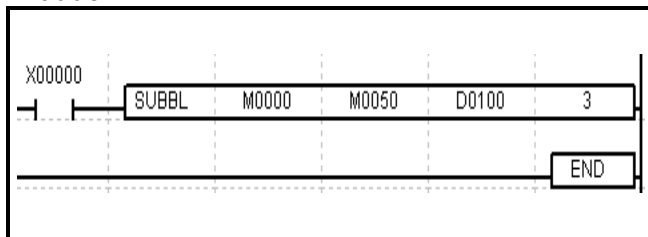

1. Subtracts the number of N words values composed of BCD code beginning with S2 from word value of S1 composed of BCD code and then stores the result into the number of N destination words beginning with D as BCD code.
2. If any of the value not composed of the BCD code is detected in S1 and S2, error flag is SET.
3. If any of the result value in the range from D to D+N is negative number in word area, it is stored as 'h9999'.
4. If any of the result value in the range from D to D+N is '0', zero flag is SET.

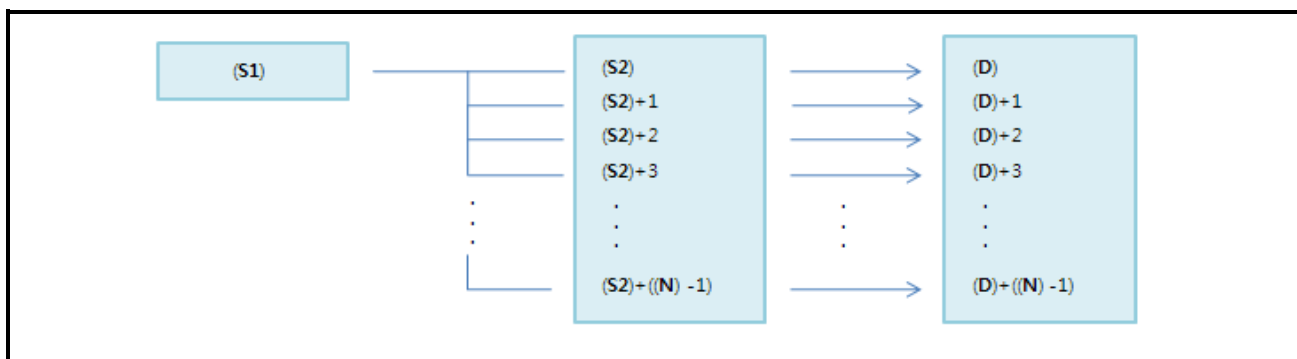
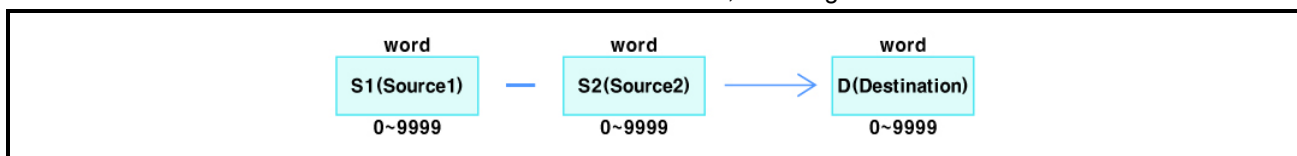

**3.2.153 Arithmetic operation instruction(DSUBBL)**

Arithmetic operation instruction			<b>DSUBBL</b>	<b>S1</b>	<b>S2</b>	<b>D</b>	<b>N</b>	Applicable model LP-S044, LP-S070				
OP	DATA type	Available device / Description / Range						Error	Zero	Carry	Borrow	Step
<b>S1</b>	DWORD	X, Y, F, Z, T, C, M, S, L, D, UW, integer						☉	☉		☉	9
		Data address to execute the BCD subtraction operation with S2 h00000000 to h99999999										
<b>S2</b>	DWORD	X, Y, F, Z, T, C, M, S, L, D, UW										
		Data address to execute the BCD subtraction operation with S1 h00000000 to h99999999										
<b>D</b>	DWORD	Y, F, Z, T, C, M, S, L, D, UW										
		Address to save the operation result h00000000 to h99999999										
<b>N</b>	WORD	X, Y, F, Z, T, C, M, S, L, D, UW, integer										
		The number of S2 data address and saved address to execute the operation with S1										
		In the range within the corresponding device area of S2 and D										

<Ladder>

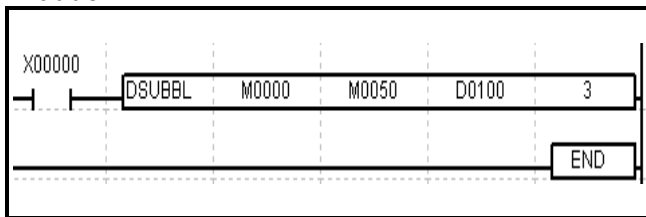

1. Subtracts the number of N double word values from S2 to S2(N-1), composed of BCD code, from the double word value of S1 composed of BCD code respectively, and then stores the result into the number of N destination double words beginning with D as BCD code.
2. If any of the value not composed of the BCD code is detected in S1 and S2, error flag is SET.
3. If any of the result value in the range from D to D+N is out of the D range, carry flag is SET.
4. If any of the result value in the range from D to D+N is '0', zero flag is SET.

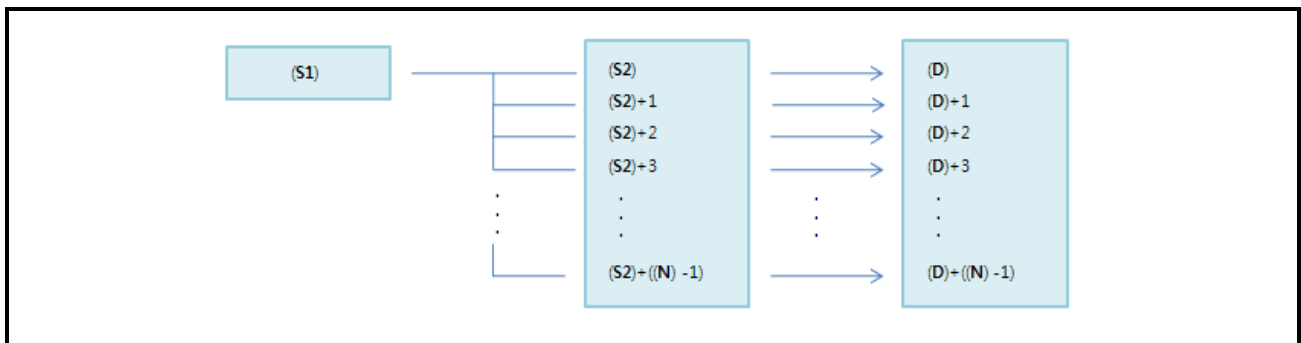
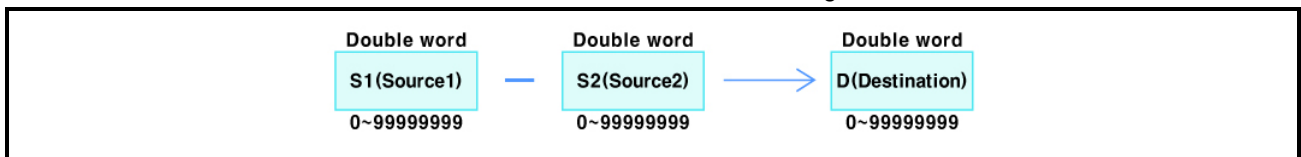

### 3.2.154 Arithmetic operation instruction(MULB)

<b>Arithmetic operation instruction</b>		<b>MULB</b>	<b>S1</b>	<b>S2</b>	<b>D</b>	Applicable model LP-S044, LP-S070				
OP	DATA type	Available device / Description / Range				Error	Zero	Carry	Borrow	Step
<b>S1</b>	WORD	X, Y, F, Z, T, C, M, S, L, D, UW, integer				☉	☉	☉		7
		Data address to execute the BCD multiplication with S2								
		h0000 to h9999								
<b>S2</b>	WORD	X, Y, F, Z, T, C, M, S, L, D, UW, integer								
		Data address to execute the BCD multiplication with S1								
		h0000 to h9999								
<b>D</b>	DWORD	Y, F, Z, T, C, M, S, L, D, UW								
		Address to save the operation result								
		h00000000 to h99999999								

<Ladder>

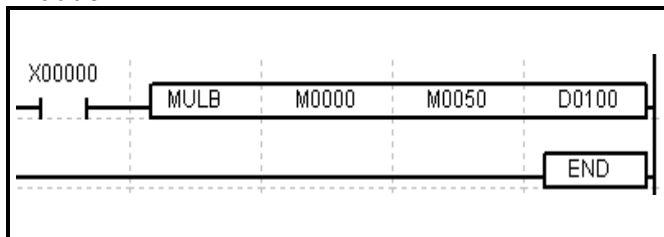

1. Multiplies the word value of S1 and that of S2, both are composed of BCD code and then stores the result into the destination double word D as BCD code.
2. If any of the value not composed of the BCD code is detected in S1 and S2, error flag is SET. (Except 0 to 9999)
3. If the result value is out of the D range, carry flag is SET.
4. If the result value is '0', zero flag is SET.

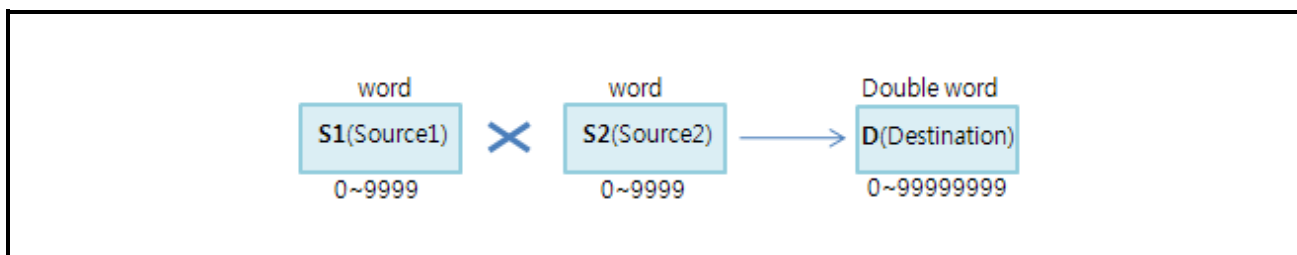

### 3.2.155 Arithmetic operation instruction(DMULB)

Arithmetic operation instruction			DMULB	S1	S2	D	Applicable model LP-S044, LP-S070				
OP	DATA type	Available device / Description / Range					Error	Zero	Carry	Borrow	Step
S1	DWORD	X, Y, F, Z, T, C, M, S, L, D, UW, integer					☉	☉	☉		7
		Data address to execute the BCD multiplication with S2									
		h00000000 to h99999999									
S2	DWORD	X, Y, F, Z, T, C, M, S, L, D, UW, integer									
		Data address to execute the BCD multiplication with S1									
		h00000000 to h99999999									
D	QWORD	Y, F, Z, T, C, M, S, L, D, UW									
		Address to save the operation result									

<Ladder>

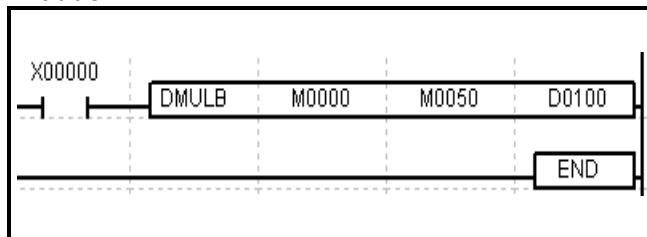

1. Multiplies the double word value of S1 and that of S2, both are composed of BCD code, and then stores the result into the destination quad word D as BCD code.
2. If any of the value not composed of the BCD code is detected in S1 and S2, error flag is SET.  
(Except 0 to 99999999)
3. If the result value is out of the D range, carry flag is SET.
4. If the result value is '0', zero flag is SET.

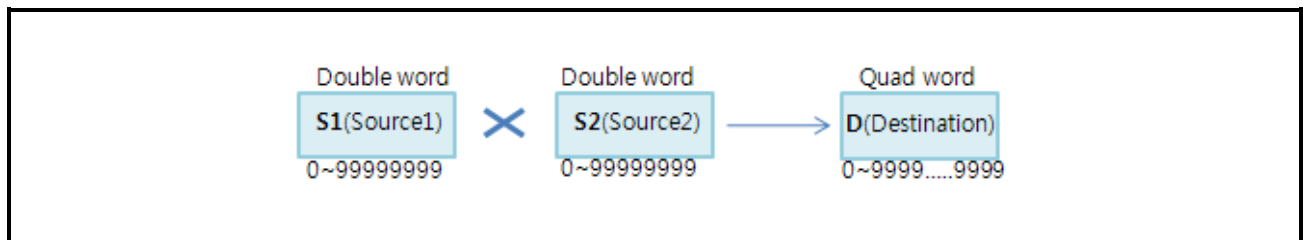

### 3.2.156 Arithmetic operation instruction(MULBL)

Arithmetic operation instruction		MULBL	S1	S2	D	N	Applicable model				
							LP-S044, LP-S070				
OP	DATA type	Available device / Description / Range					Error	Zero	Carry	Borrow	Step
S1	WORD	X, Y, F, Z, T, C, M, S, L, D, UW, integer					⊙	⊙	⊙		9
		Data address to execute the BCD multiplication with S2 h0000 to h9999									
S2	WORD	X, Y, F, Z, T, C, M, S, L, D, UW									
		Data address to execute the BCD multiplication with S1 h0000 to h9999									
D	WORD	Y, F, Z, T, C, M, S, L, D, UW									
		Address to save the operation result h00000000 to h99999999									
N	WORD	X, Y, F, Z, T, C, M, S, L, D, UW, integer									
		The number of S2 data address and saved address to execute the operation with S1 In the range within the corresponding device area of S2 and D									

<Ladder>

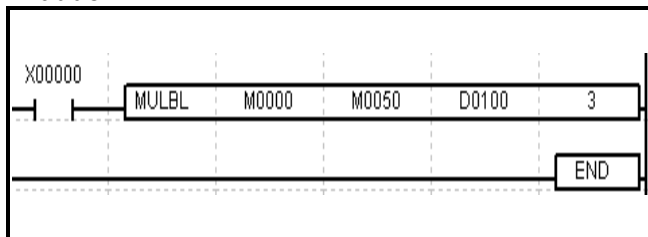

1. Multiplies the word value of S1 and the number of N word values from S2 to S2(N-1), both are composed of BCD code, one by one, and then stores the result into the number of N destination double words beginning with D as BCD code.
2. If any of the value not composed of the BCD code is detected in S1 and S2, error flag is SET.
3. If any of the result value in the range from D to D+N is out of the D range, carry flag is SET.
4. If any of the result value in the range from D to D+N is '0', zero flag is SET.

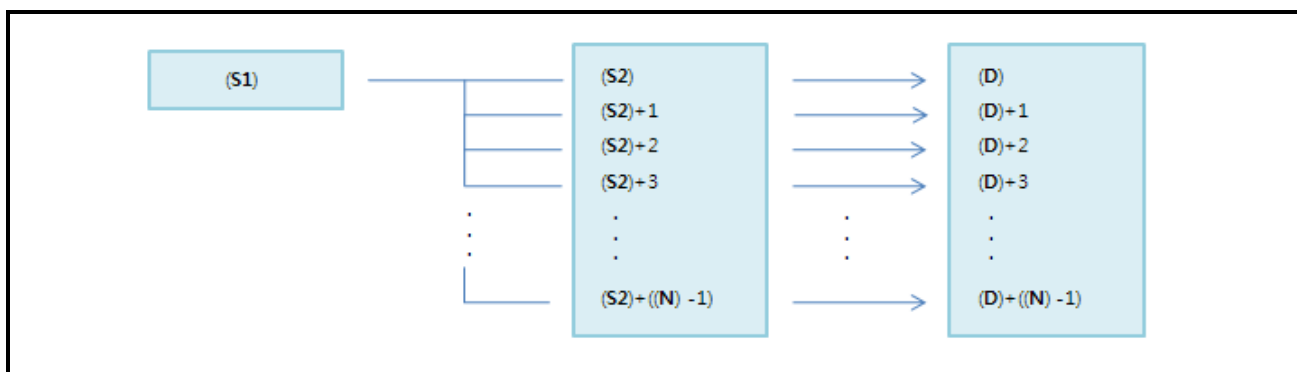
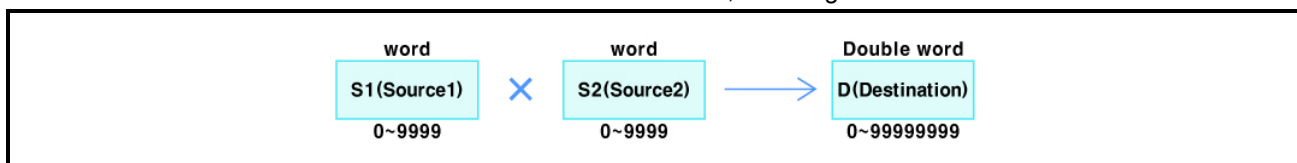

3.2.157 Arithmetic operation instruction(DMULBL)

Arithmetic operation instruction			DMULBL	S1	S2	D	N	Applicable model				
								LP-S044, LP-S070				
OP	DATA type	Available device / Description / Range						Error	Zero	Carry	Borrow	Step
S1	DWORD	X, Y, F, Z, T, C, M, S, L, D, UW, integer						⊙	⊙	⊙	□	9
		Data address to execute the BCD multiplication with S2										
		h00000000 to h99999999										
S2	DWORD	X, Y, F, Z, T, C, M, S, L, D, UW						⊙	⊙	⊙	□	9
		Data address to execute the BCD multiplication with S1										
D	QWORD	Y, F, Z, T, C, M, S, L, D, UW						⊙	⊙	⊙	□	9
		Address to save the operation result										
N	WORD	X, Y, F, Z, T, C, M, S, L, D, UW, integer						⊙	⊙	⊙	□	9
		The number of S2 data address and saved address to execute the operation with S1										
		In the range within the corresponding device area of S2 and D										

<Ladder>

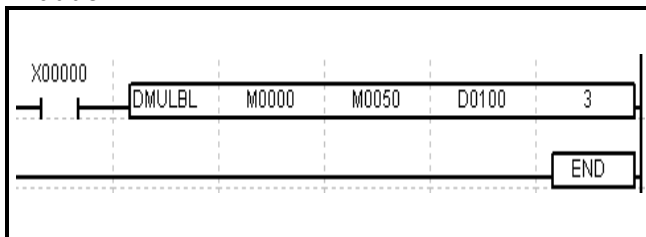

1. Multiplies the double word value of S1 composed of BCD code and the number of N double words from S2 to S2(N-1) composed of BCD code, one by one, and then stores the result into the number of N destination quad words beginning with D as BCD code.
2. If any of the value not composed of the BCD code is detected in S1 and S2, error flag is SET.
3. If any of the result value in the range from D to D+N is out of the D range, carry flag is SET.
4. If any of the result value in the range from D to D+N is '0', zero flag is SET.

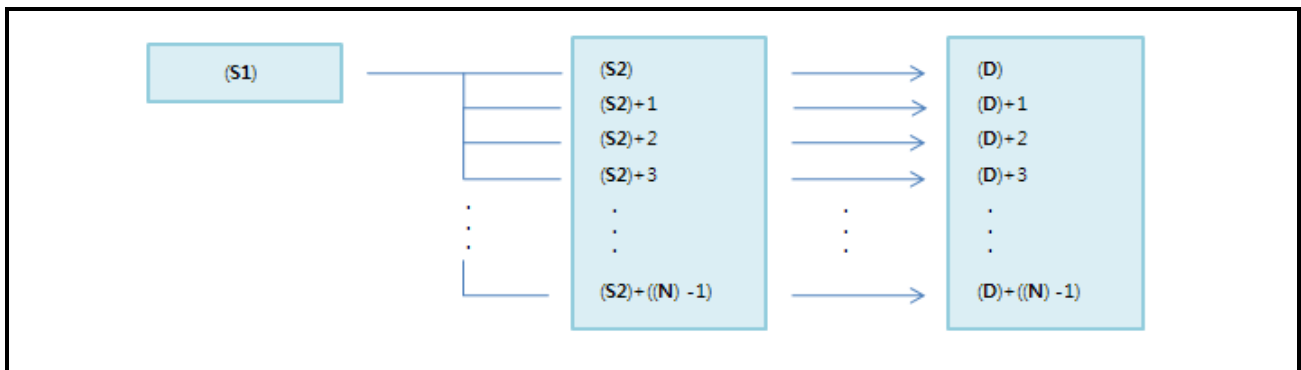
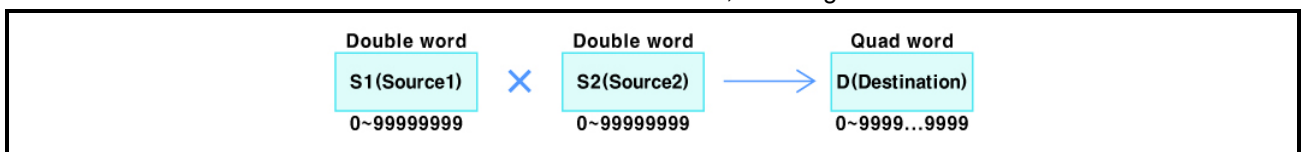

### 3.2.158 Arithmetic operation instruction(DIVB)

Arithmetic operation instruction		DIVB	S1	S2	D	Applicable model				
						LP-S044, LP-S070				
OP	DATA type	Available device / Description / Range				Error	Zero	Carry	Borrow	Step
S1	WORD	X, Y, F, Z, T, C, M, S, L, D, UW, integer				☉	☉			7
		Data address to execute the BCD division operation with S2 h0000 to h9999								
S2	WORD	X, Y, F, Z, T, C, M, S, L, D, UW, integer								
		Data address to execute the BCD division operation with S1 h0000 to h9999								
D	WORD	Y, F, Z, T, C, M, S, L, D, UW								
		Address to save the operation result h0000 to h9999								

<Ladder>

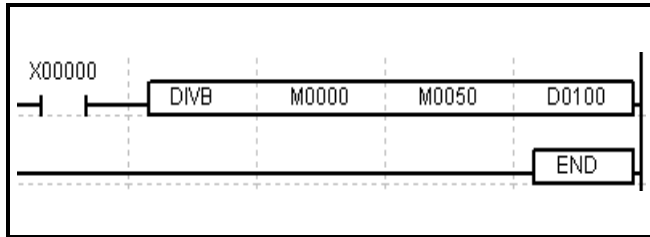

1. Divides the word value of S1 composed of BCD code by the word value of S2 composed of BCD code, and then stores the quotient and the remainder into the D and D+1 words respectively.
2. If S2 is 0, or either S1 or S2 is not the BCD code, error flag is SET.
3. If the quotient is '0', zero flag is SET.

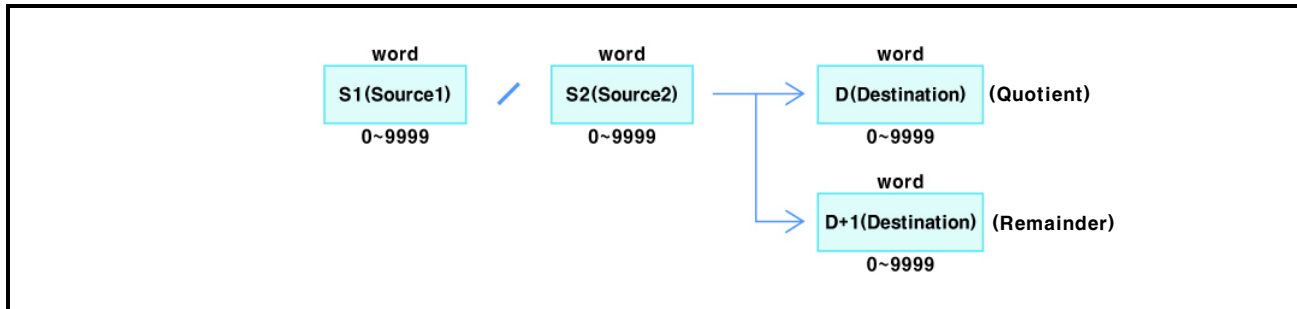



### 3.2.159 Arithmetic operation instruction(DDIVB)

Arithmetic operation instruction			DDIVB	S1	S2	D	Applicable model LP-S044, LP-S070				
OP	DATA type	Available device / Description / Range					Error	Zero	Carry	Borrow	Step
S1	DWORD	X, Y, F, Z, T, C, M, S, L, D, UW, integer					☉	☉			7
		Data address to execute the BCD division operation with S2 h00000000 to h99999999									
S2	DWORD	X, Y, F, Z, T, C, M, S, L, D, UW, integer									
		Data address to execute the BCD division operation with S1 h00000000 to h99999999									
D	DWORD	Y, F, Z, T, C, M, S, L, D, UW									
		Address to save the operation result h00000000 to h99999999									

<Ladder>

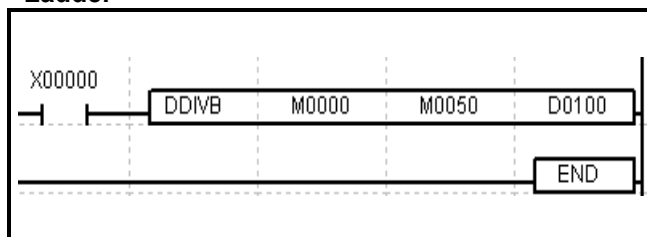

1. Divides the double word value of S1 composed of BCD code by the double word value of S2 composed of BCD code, and then stores the quotient and the remainder into the D and D+1 double words respectively.
2. If S2 is 0, or either S1 or S2 is not the BCD code, error flag is SET.
3. If the quotient is '0', zero flag is SET.

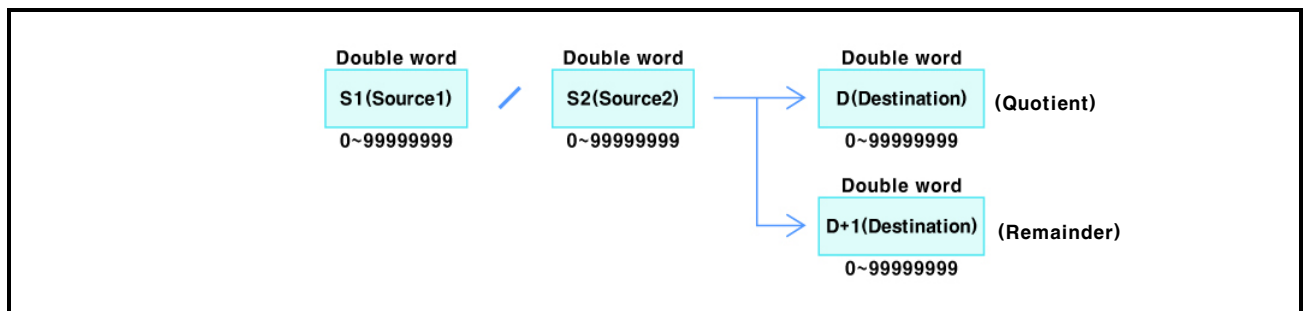

### 3.2.160 Arithmetic operation instruction(DIVBL)

Arithmetic operation instruction		DIVBL	S1	S2	D	N	Applicable model				
							LP-S044, LP-S070				
OP	DATA type	Available device / Description / Range					Error	Zero	Carry	Borrow	Step
S1	WORD	X, Y, F, Z, T, C, M, S, L, D, UW, integer					☉	☉			9
		Data address to execute the BCD division operation with S2 h0000 to h9999									
S2	WORD	X, Y, F, Z, T, C, M, S, L, D, UW									
		Data address to execute the BCD division operation with S1 h0000 to h9999									
D	WORD	Y, F, Z, T, C, M, S, L, D, UW									
		Address to save the operation result h0000 to h9999									
N	WORD	X, Y, F, Z, T, C, M, S, L, D, UW, integer									
		The number of S2 data address and saved address to execute the operation with S1 In the range within the corresponding device area of S2 and D									

<Ladder>

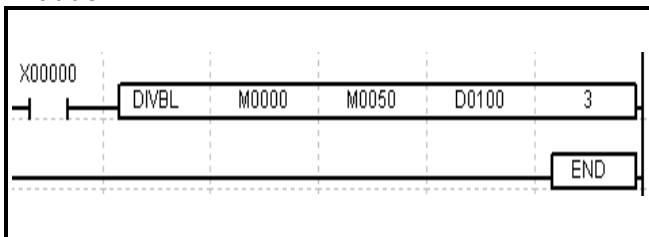

1. Divides the word value of S1 composed of BCD code by the number of N word values from S2 to S2(N-1) composed of BCD code, and then stores the quotient and the remainder into the D and D+1 double words respectively.
2. If S2 is 0, or either S1 or S2 is not the BCD code, error flag is SET.
3. If the quotient is '0', zero flag is SET.

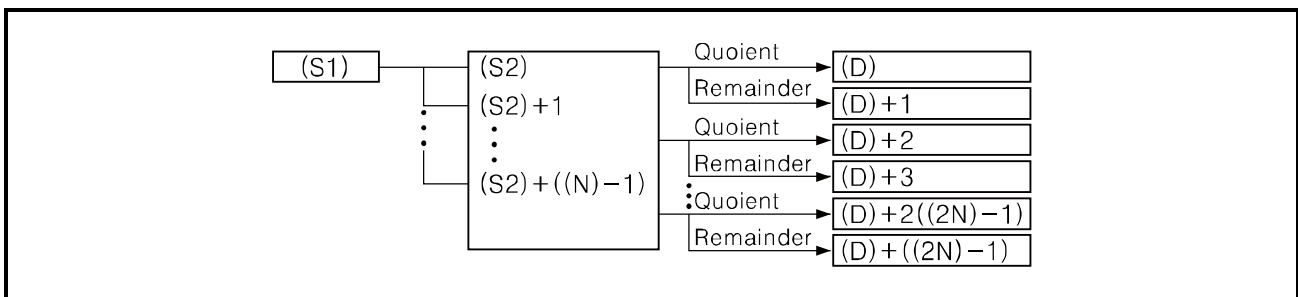
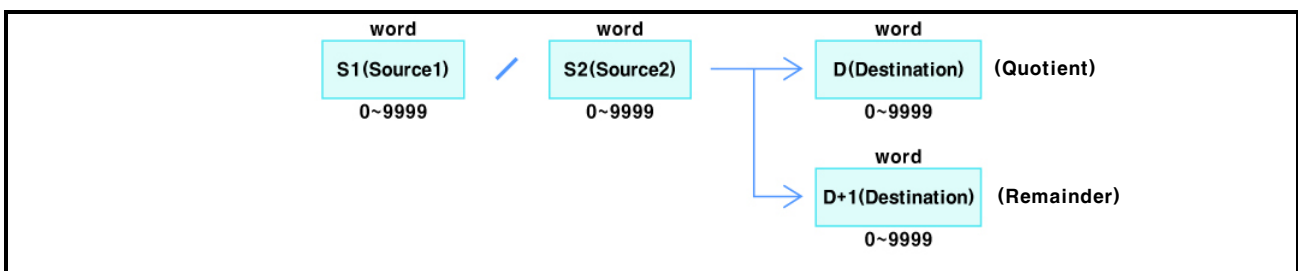

### 3.2.161 Arithmetic operation instruction(DDIVBL)

Arithmetic operation instruction			<b>DDIVBL</b>	<b>S1</b>	<b>S2</b>	<b>D</b>	<b>N</b>	Applicable model LP-S044, LP-S070				
OP	DATA type	Available device / Description / Range						Error	Zero	Carry	Borrow	Step
<b>S1</b>	DWORD	X, Y, F, Z, T, C, M, S, L, D, UW, integer						☉	☉			6
		Data address to execute the BCD division operation with S2 h00000000 to h99999999										
<b>S2</b>	DWORD	X, Y, F, Z, T, C, M, S, L, D, UW										
		Data address to execute the BCD division operation with S1 h00000000 to h99999999										
<b>D</b>	DWORD	Y, F, Z, T, C, M, S, L, D, UW										
		Address to save the operation result h00000000 to h99999999										
<b>N</b>	WORD	X, Y, F, Z, T, C, M, S, L, D, UW, integer										
		The number of S2 data address and saved address to execute the operation with S1 In the range within the corresponding device area of S2 and D										

<Ladder>

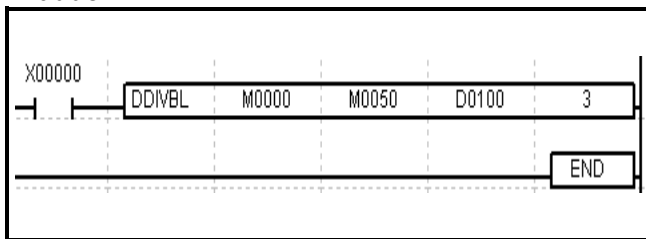

1. Divides the double word value of S1 composed of BCD code by the number of N double word values from S2 to S2(N-1), composed of BCD code, and then stores the quotient and the remainder into the D and D+1 double words respectively.
2. If S2 is 0, or either S1 or S2 is not the BCD code, error flag is SET.
3. If the quotient is '0', zero flag is SET.

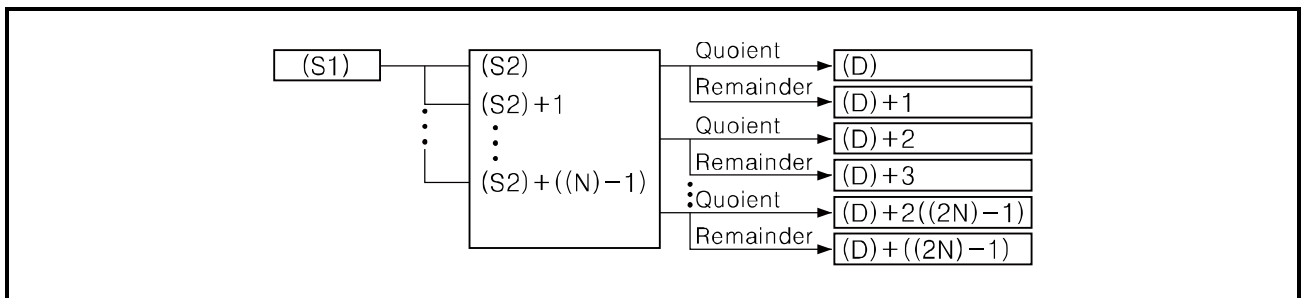
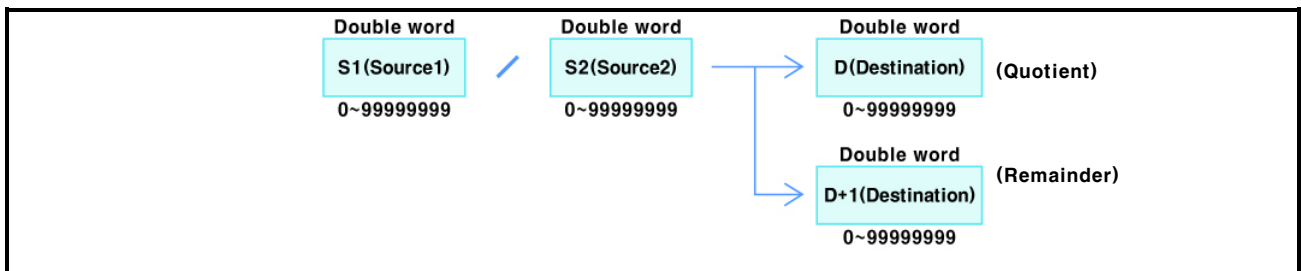

### 3.2.162 Arithmetic operation instruction(INCB)

<b>Arithmetic operation instruction</b>		<b>INCB</b>	<b>D</b>	Applicable model LP-S044, LP-S070					
OP	DATA type	Available device / Description / Range			Error	Zero	Carry	Borrow	Step
<b>D</b>	WORD	Y, F, Z, T, C, M, S, L, D, UW			☉	☉	☉		3
		BCD data address to execute the operation							
		h0000 to h9999							

<Ladder>

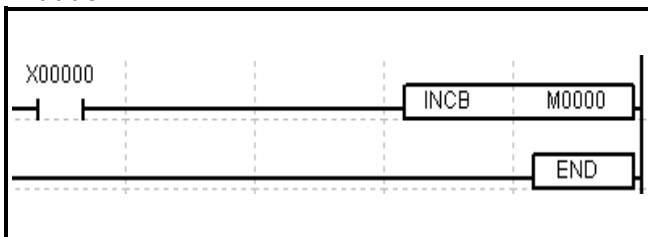

1. Increases the word value of D composed of BCD code by 1 as BCD code.
2. If the word value of D is not the BCD code, error flag is SET.
3. If the increased result is 0(BCD), zero flag is SET.
4. If the result value is out of the D word range, carry flag is SET.

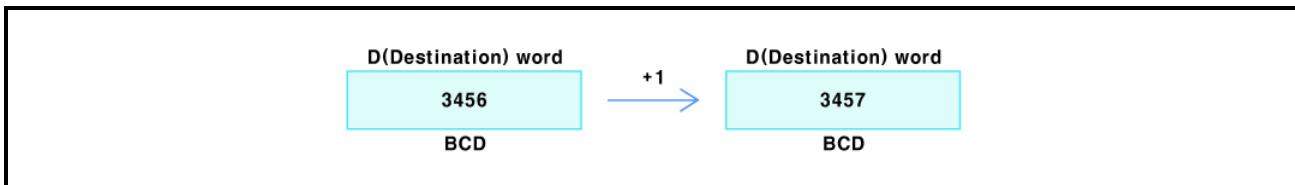

**3.2.163 Arithmetic operation instruction(DINCB)**

<b>Arithmetic operation instruction</b>			<b>DINCB</b>	<b>D</b>	Applicable model LP-S044, LP-S070				
OP	DATA type	Available device / Description / Range			Error	Zero	Carry	Borrow	Step
D	DWORD	Y, F, Z, T, C, M, S, L, D, UW			⊙	⊙	⊙		3
		BCD data address to execute the operation							
		h00000000 to h99999999							

<Ladder>

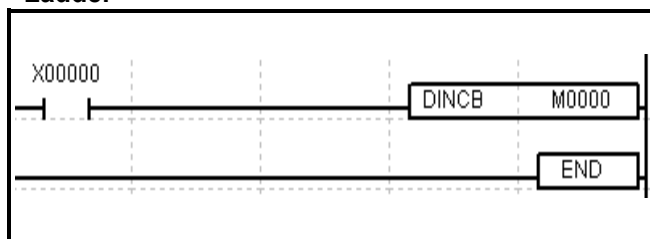

1. Increases the double word value of D composed of BCD code by 1 as BCD code.
2. If the double word value of D is not the BCD code, error flag is SET.
3. If the increased result is 0(BCD), zero flag is SET.
4. If the result value is out of the D double word range, carry flag is SET.

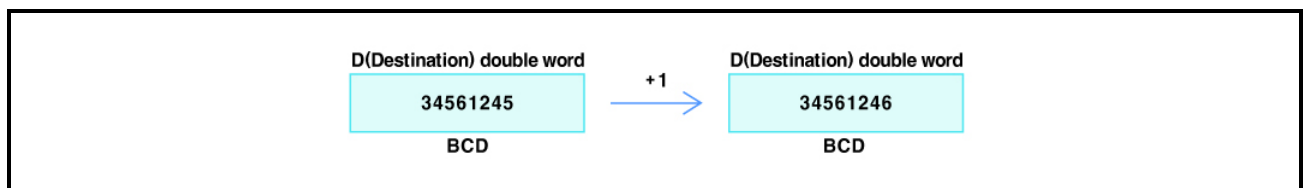

### 3.2.164 Arithmetic operation instruction(DEC B)

<b>Arithmetic operation instruction</b>		<b>DEC B</b>	<b>D</b>	Applicable model LP-S044, LP-S070					
OP	DATA type	Available device / Description / Range			Error	Zero	Carry	Borrow	Step
<b>D</b>	WORD	Y, F, Z, T, C, M, S, L, D, UW			☉	☉		☉	3
		BCD data address to execute the operation							
		h0000 to h9999							

<Ladder>

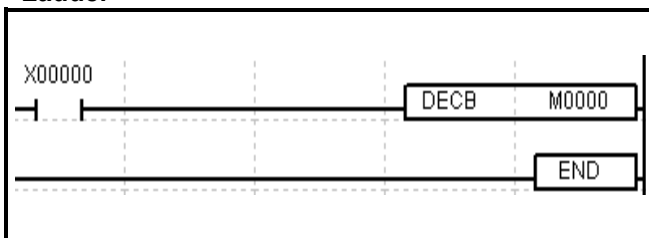

1. Decreases the word value of D composed of BCD code by 1 as BCD code.
2. If the word value of D is not the BCD code, error flag is SET.
3. If the decreased result is 0(BCD), zero flag is SET.
4. If the result value is out of D word range, borrow flag is SET.

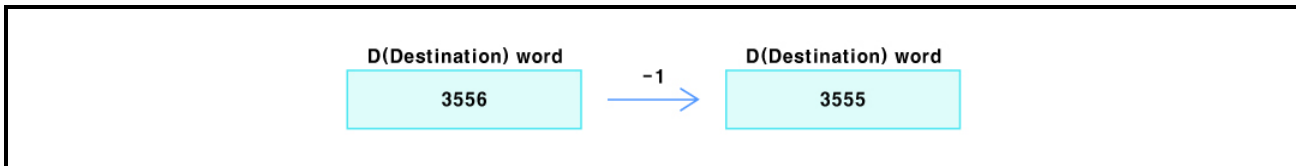

### 3.2.165 Arithmetic operation instruction(DDECB)

Arithmetic operation instruction			DDECB	D	Applicable model				
					LP-S044, LP-S070				
OP	DATA type	Available device / Description / Range			Error	Zero	Carry	Borrow	Step
D	DWORD	Y, F, Z, T, C, M, S, L, D, UW			☉	☉		☉	3
		BCD data address to execute the operation							
		h00000000 to h99999999							

<Ladder>

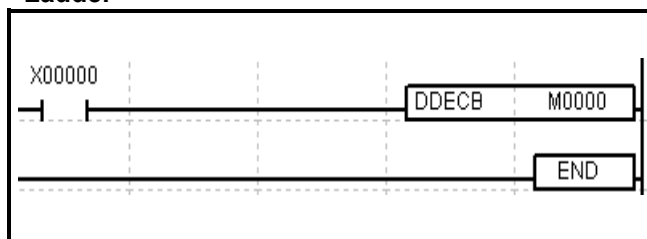

1. Decreases the double word of D composed of BCD code by 1 as BCD code.
2. If the double word value of D is not BCD code, error flag is SET.
3. If the decreased result is 0(BCD), zero flag is SET.
4. If the result value is out of the D double word range, borrow flag is SET.



### 3.2.166 Logical operation instruction(WAND)

<b>Logical operation instruction</b>			<b>WAND</b>	<b>S1</b>	<b>S2</b>	<b>D</b>	Applicable model LP-S044, LP-S070				
OP	DATA type	Available device / Description / Range					Error	Zero	Carry	Borrow	Step
S1	WORD	X, Y, F, Z, T, C, M, S, L, D, UW, integer						⊙			7
		Data address to execute the '&' operation with S2									
		0(h0000) to 65535(hFFFF)									
S2	WORD	X, Y, F, Z, T, C, M, S, L, D, UW, integer									
		Data address to execute the '&' operation with S1									
		0(h0000) to 65535(hFFFF)									
D	WORD	Y, F, Z, T, C, M, S, L, D, UW									
		Address to save the operation result									
		0(h0000) to 65535(hFFFF)									

<Ladder>

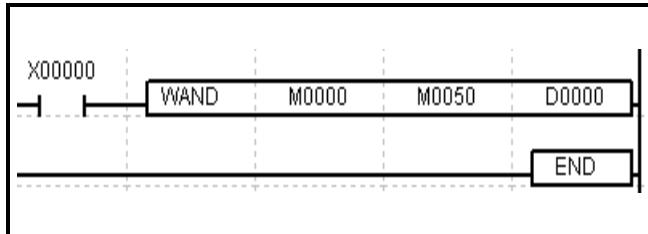

1. Executes the '&' operation for every bit of S1 word and the corresponding bit of S2 word and then stores the result into the D word.
2. If the result value is '0', zero flag is SET.

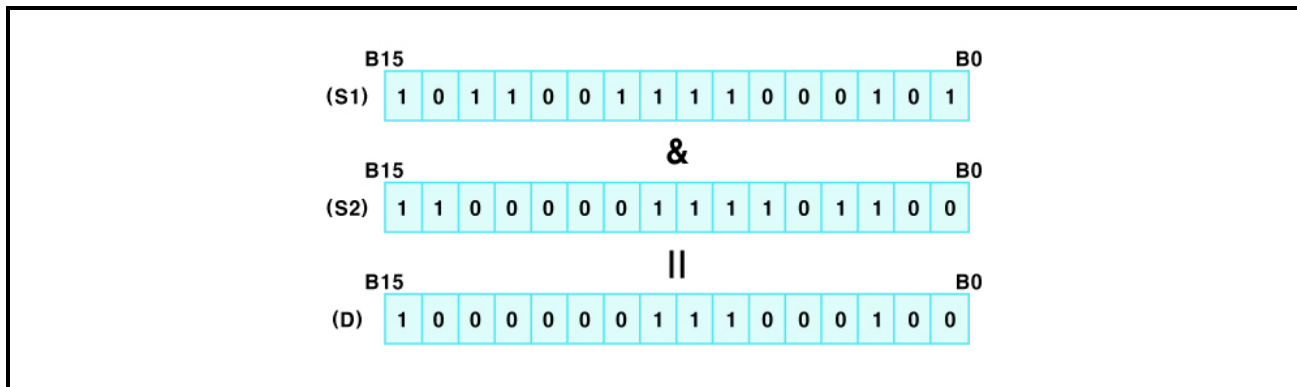



### 3.2.167 Logical operation instruction(DAND)

Logical operation instruction			DAND	S1	S2	D	Applicable model				
							LP-S044, LP-S070				
OP	DATA type	Available device / Description / Range					Error	Zero	Carry	Borrow	Step
S1	DWORD	X, Y, F, Z, T, C, M, S, L, D, UW, integer					<input type="checkbox"/>	<input checked="" type="checkbox"/>	<input type="checkbox"/>	<input type="checkbox"/>	7
		Data address to execute the '&' operation with S2 0(h0000) to 4294967295(hFFFFFFF)									
S2	DWORD	X, Y, F, Z, T, C, M, S, L, D, UW, integer					<input type="checkbox"/>	<input type="checkbox"/>	<input type="checkbox"/>	<input type="checkbox"/>	
		Data address to execute the '&' operation with S1 0(h0000) to 4294967295(hFFFFFFF)									
D	DWORD	Y, F, Z, T, C, M, S, L, D, UW					<input type="checkbox"/>	<input type="checkbox"/>	<input type="checkbox"/>	<input type="checkbox"/>	
		Address to save the operation result 0(h0000) to 4294967295(hFFFFFFF)									

<Ladder>

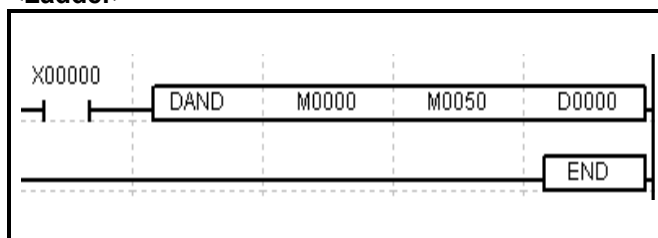

1. Executes the '&' operation for every bit of S1 double word and the corresponding bit of S2 double word and then stores the result into the D double word.
2. If the result value is '0', zero flag is SET.

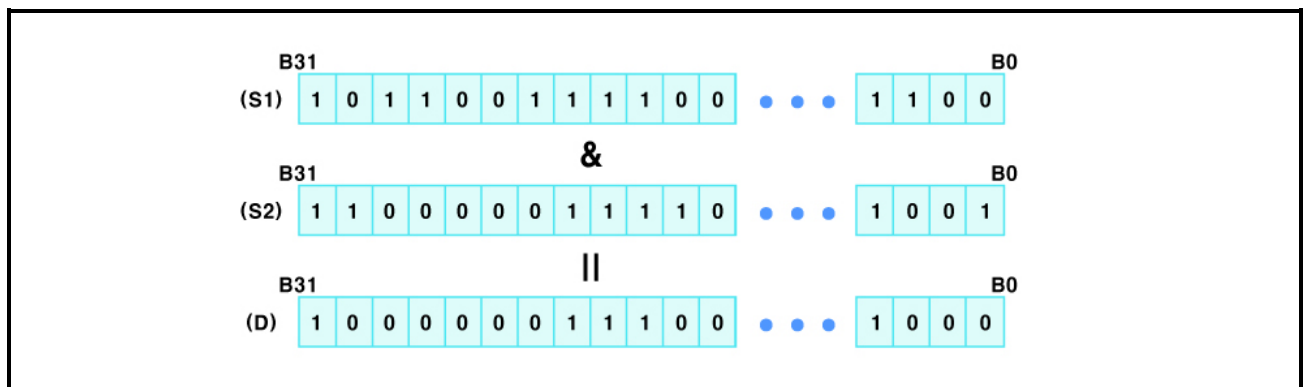

### 3.2.168 Logical operation instruction(AAND)

OP	DATA type	Available device / Description / Range
S1	BIT	X, Y, F, T, C, M, UB
		Start address of the bit device to execute the '&' operation with S2
		Not applicable
S2	BIT	X, Y, F, T, C, M, UB
		Start address of the bit device to execute the '&' operation with S1
		Not applicable
D	BIT	Y, F, T, C, M, UB
		Start address of the bit device to store the operation result
		Not applicable
N	WORD	X, Y, F, Z, T, C, M, S, L, D, UW, integer
		The number of bit device to execute the operation including the start address
		As many as the number of devices remained in the corresponding S1, S2, and D area

  

Applicable model	LP-S044, LP-S070
Error	
Zero	⊙
Carry	
Borrow	
Step	9

<Ladder>

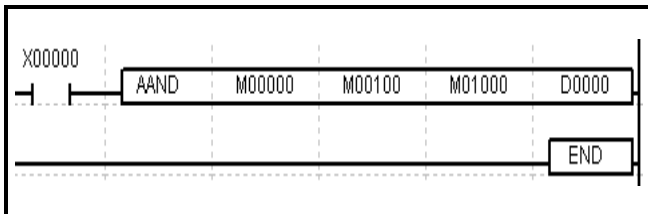

Executes the '&' operation for the number of N bits, from S1 to SN, and the number of N bits, from S2 to S2(N-1), and then stores the result into the number of N bits beginning with D.

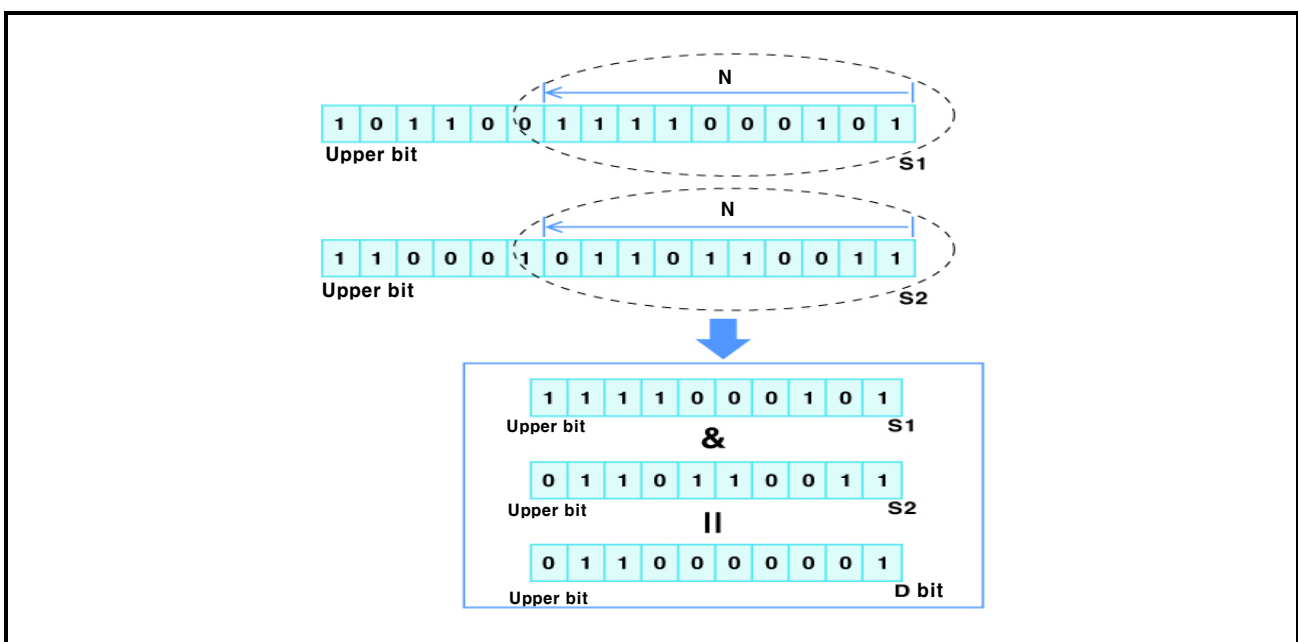

3.2.169 Logical operation instruction(WANDL)

Logical operation instruction			WANDL	S1	S2	D	N	Applicable model				
								LP-S044, LP-S070				
OP	DATA type	Available device / Description / Range						Error	Zero	Carry	Borrow	Step
S1	WORD	X, Y, F, Z, T, C, M, S, L, D, UW, integer							⊙			9
		Data address to execute the '&' operation with S2 0(h0000) to 65535(hFFFF)										
S2	WORD	X, Y, F, Z, T, C, M, S, L, D, UW										
		Data address to execute the '&' operation with S1 0(h0000) to 65535(hFFFF)										
D	WORD	Y, F, Z, T, C, M, S, L, D, UW										
		Address to save the operation result 0(h0000) to 65535(hFFFF)										
N	WORD	X, Y, F, Z, T, C, M, S, L, D, UW, integer										
		The number of S2 data address and saved address to execute the operation with S1 In the range within the corresponding device area of S2 and D										

<Ladder>

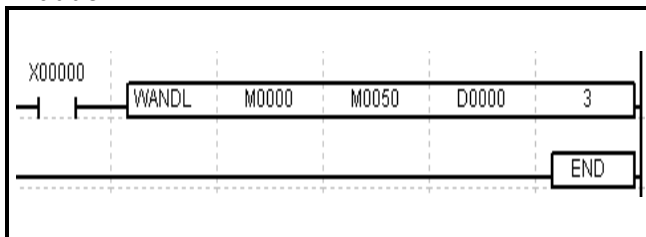

1. Executes the bitwise '&' operation for every bit of S1 word and the number of N words from S2 to S2(N-1) and then stores the result into the number of N words beginning with D.
2. If the result value is '0' word, zero flag is SET.

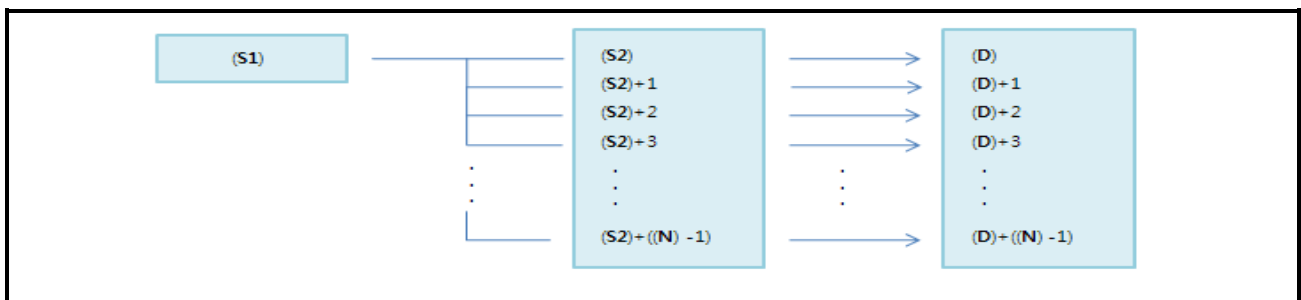
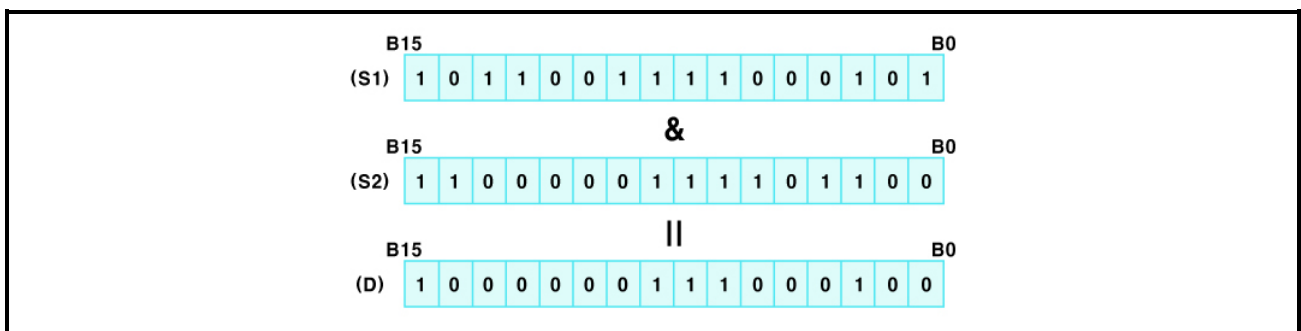

### 3.2.170 Logical operation instruction(DANDL)

Logical operation instruction		DANDL	S1	S2	D	N	Applicable model				
							LP-S044, LP-S070				
OP	DATA type	Available device / Description / Range					Error	Zero	Carry	Borrow	Step
S1	DWORD	X, Y, F, Z, T, C, M, S, L, D, UW, integer						Zero			9
		Data address to execute the '&' operation with S2 0(h0000) to 4294967295(hFFFFFFF)									
S2	DWORD	X, Y, F, Z, T, C, M, S, L, D, UW						Zero			9
		Data address to execute the '&' operation with S1 0(h0000) to 4294967295(hFFFFFFF)									
D	DWORD	Y, F, Z, T, C, M, S, L, D, UW						Zero			9
		Address to save the operation result 0(h0000) to 4294967295(hFFFFFFF)									
N	WORD	X, Y, F, Z, T, C, M, S, L, D, UW, integer						Zero			9
		The number of S2 data address and saved address to execute the operation with S1 In the range within the corresponding device area of S2 and D									

<Ladder>

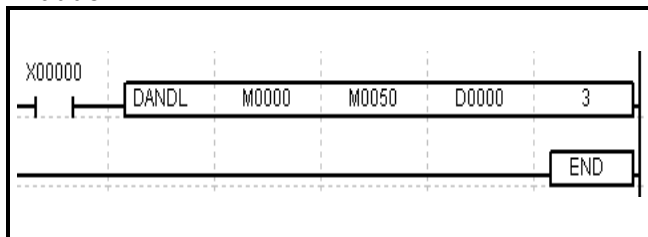

1. Executes the bitwise '&' operation for every bit of S1 double words and the number of N words from S2 to S2(N-1) and then stores the result into the number of N words beginning with D.
2. If the result value is '0' double word, zero flag is SET.

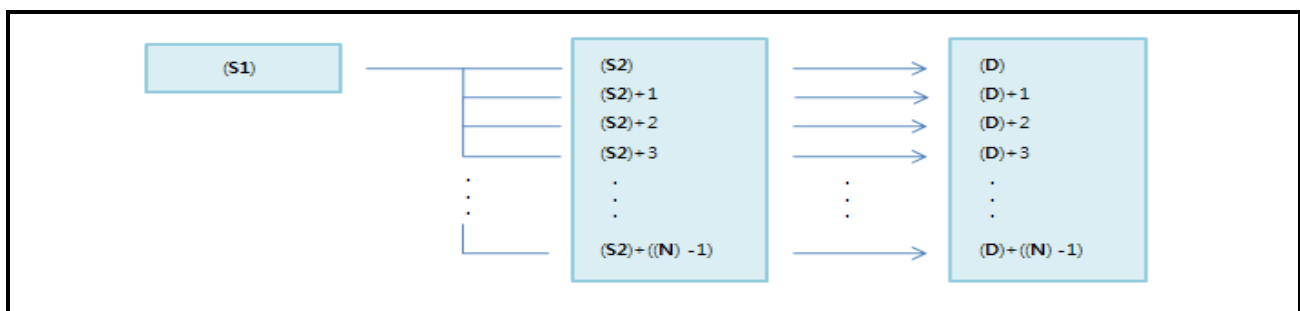
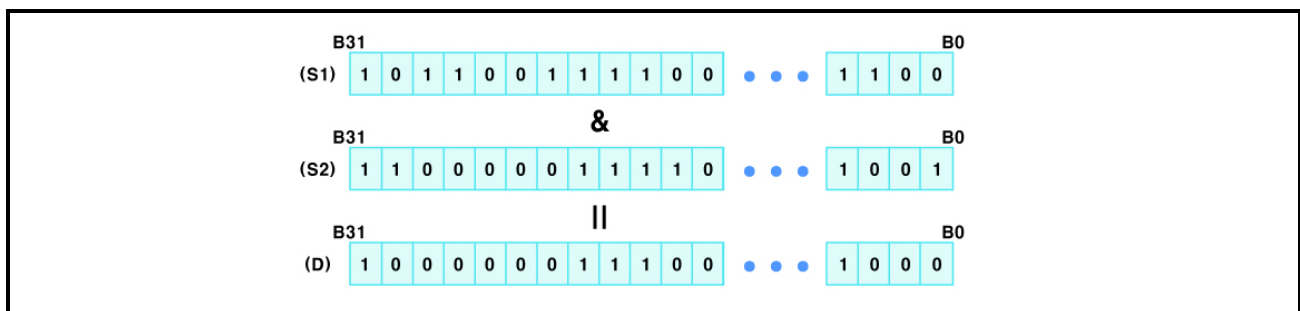

### 3.2.171 Logical operation instruction(WOR)

Logical operation instruction			WOR	S1	S2	D	Applicable model				
							LP-S044, LP-S070				
OP	DATA type	Available device / Description / Range					Error	Zero	Carry	Borrow	Step
S1	WORD	X, Y, F, Z, T, C, M, S, L, D, UW, integer						☉			7
		Data address to execute the 'OR' operation with S2									
		0(h0000) to 65535(hFFFF)									
S2	WORD	X, Y, F, Z, T, C, M, S, L, D, UW, integer						☉			7
		Data address to execute the 'OR' operation with S1									
		0(h0000) to 65535(hFFFF)									
D	WORD	Y, F, Z, T, C, M, S, L, D, UW						☉			7
		Address to save the operation result									
		0(h0000) to 65535(hFFFF)									

<Ladder>

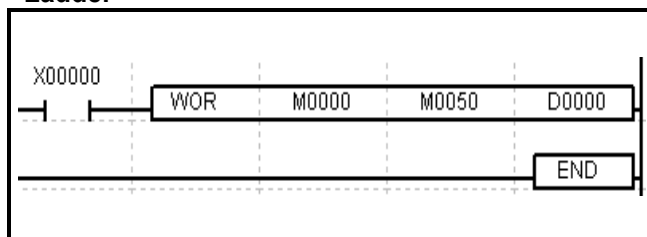

1. Executes the logical 'OR' operation for every bit in S1 words and the corresponding bit of S2 words, and then stores the result into the D word.
2. If the result value is '0', zero flag is SET.

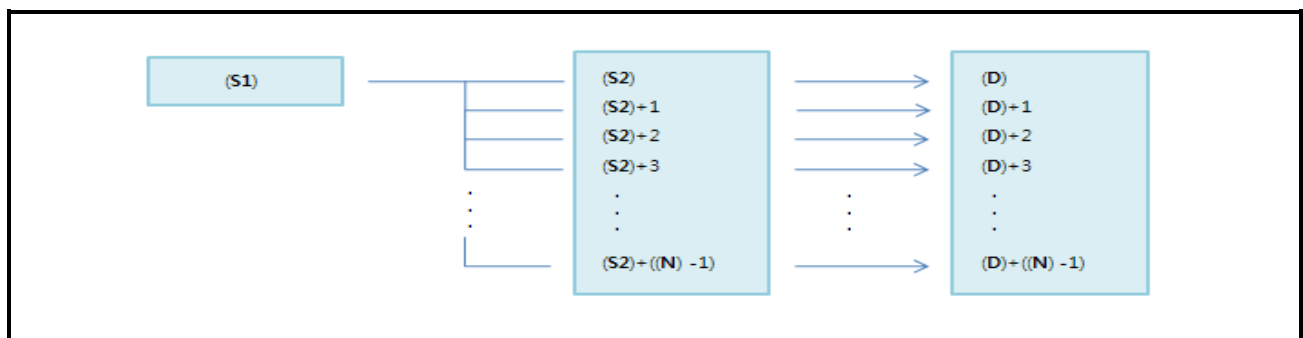
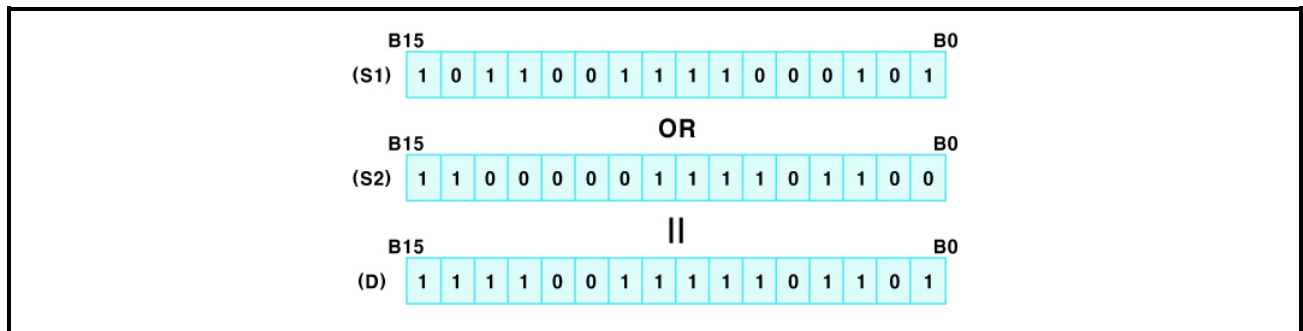

### 3.2.172 Logical operation instruction(DOR)

Logical operation instruction		DOR	S1	S2	D	Applicable model				
						LP-S044, LP-S070				
OP	DATA type	Available device / Description / Range				Error	Zero	Carry	Borrow	Step
S1	DWORD	X, Y, F, Z, T, C, M, S, L, D, UW, integer				<input type="checkbox"/>	<input checked="" type="checkbox"/>	<input type="checkbox"/>	<input type="checkbox"/>	5
		Data address to execute the 'OR' operation with S2								
		0(h0000) to 4294967295(hFFFFFFF)								
S2	DWORD	X, Y, F, Z, T, C, M, S, L, D, UW, integer				<input type="checkbox"/>	<input type="checkbox"/>	<input type="checkbox"/>	<input type="checkbox"/>	
		Data address to execute the 'OR' operation with S1								
		0(h0000) to 4294967295(hFFFFFFF)								
D	DWORD	Y, F, Z, T, C, M, S, L, D, UW				<input type="checkbox"/>	<input type="checkbox"/>	<input type="checkbox"/>	<input type="checkbox"/>	
		Address to save the operation result								
		0(h0000) to 4294967295(hFFFFFFF)								

<Ladder>

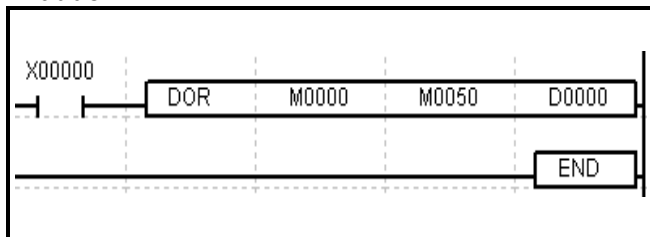

1. Executes the logical 'OR' operation for every bit of S1 double words and the corresponding bit of S2 double words, and then stores the result into the D double word.
2. If the result value is '0', zero flag is SET.

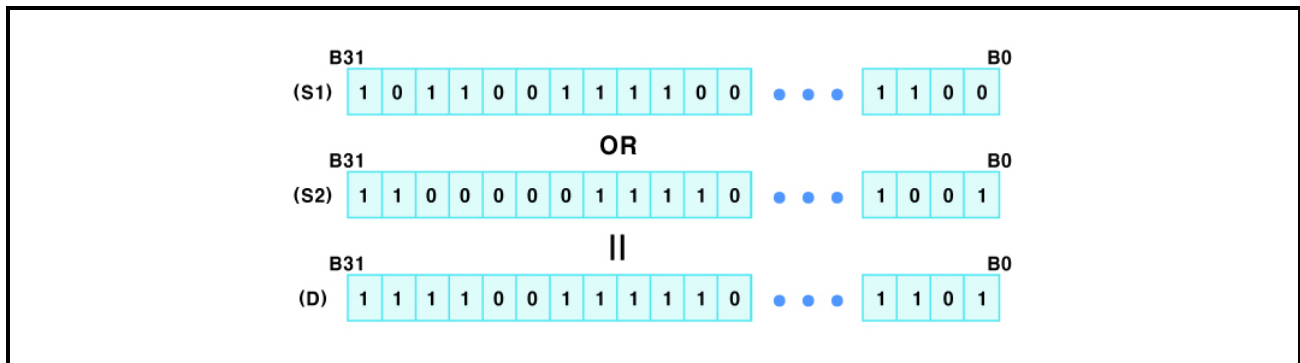

### 3.2.173 Logical operation instruction(AOR)

Logical operation instruction			AOR	S1	S2	D	N	Applicable model				
								LP-S044, LP-S070				
OP	DATA type	Available device / Description / Range						Error	Zero	Carry	Borrow	Step
S1	BIT	X, Y, F, T, C, M, UB							⊙			9
		Data address to execute the 'OR' operation with S2										
		Not applicable										
S2	BIT	X, Y, F, T, C, M, UB							⊙			9
		Data address to execute the 'OR' operation with S1										
		Not applicable										
D	BIT	Y, F, T, C, M, UB							⊙			9
		Start address of the bit device to save the operation result										
		Not applicable										
N	WORD	X, Y, F, Z, T, C, M, S, L, D, UW, integer							⊙			9
		The number of bit devices to execute the operation including the start address										
		As many as the number of devices remained in the corresponding S1, S2, and D area										

<Ladder>

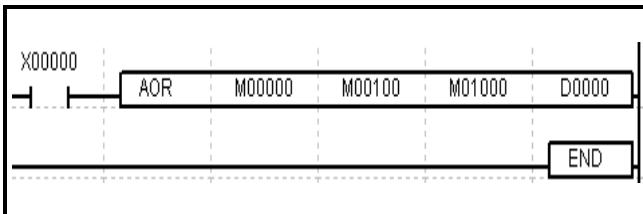

Executes the logical 'OR' operation for the number of N bits from S1 to SN and the number of N bits from S2 to S2(N- 1), and then stores the result into the the number of N bits beginning with D.

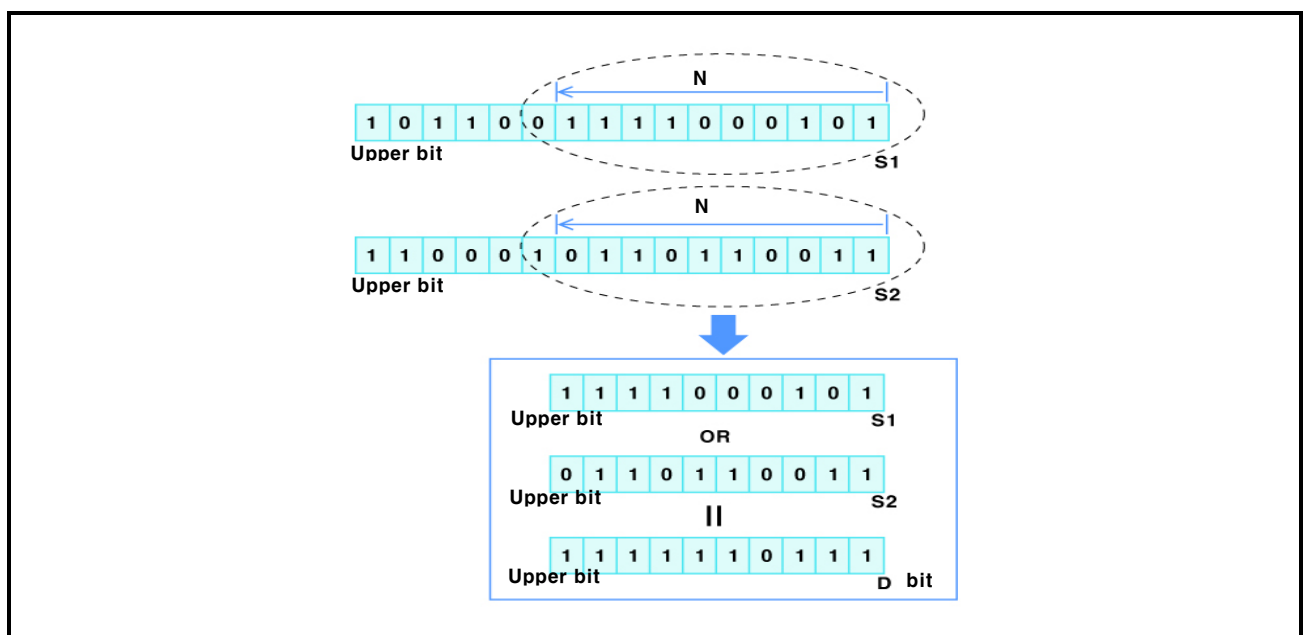

### 3.2.174 Logical operation instruction(WORL)

Logical operation instruction		WORL	S1	S2	D	N	Applicable model				
							LP-S044, LP-S070				
OP	DATA type	Available device / Description / Range					Error	Zero	Carry	Borrow	Step
S1	WORD	X, Y, F, Z, T, C, M, S, L, D, UW, integer					<input type="checkbox"/>	<input type="checkbox"/>	<input type="checkbox"/>	<input type="checkbox"/>	9
		Data address to execute the 'OR' operation with S2									
		0(h0000) to 65535(hFFFF)									
S2	WORD	X, Y, F, Z, T, C, M, S, L, D, UW					<input type="checkbox"/>	<input checked="" type="checkbox"/>	<input type="checkbox"/>	<input type="checkbox"/>	
		Data address to execute the 'OR' operation with S1									
		0(h0000) to 65535(hFFFF)									
D	WORD	Y, F, Z, T, C, M, S, L, D, UW					<input type="checkbox"/>	<input type="checkbox"/>	<input type="checkbox"/>	<input type="checkbox"/>	
		Address to save the operation result									
		0(h0000) to 65535(hFFFF)									
N	WORD	X, Y, F, Z, T, C, M, S, L, D, UW, integer					<input type="checkbox"/>	<input type="checkbox"/>	<input type="checkbox"/>	<input type="checkbox"/>	
		The number of S2 data address and saved address to execute the operation with S1									
		In the range within the corresponding device area of S2 and D									

<Ladder>

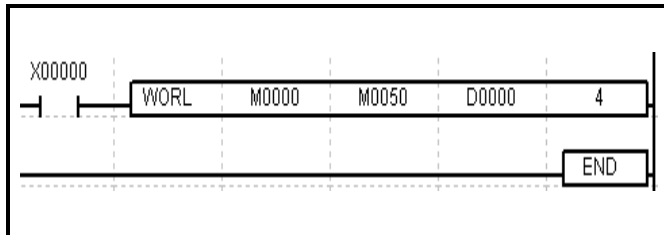

1. Executes the bitwise logical 'OR' operation for every bit of S1 words and the number of N words from S2 to S2(N-1), and then stores the result into the D word.
2. If the result value is '0' word, zero flag is SET.

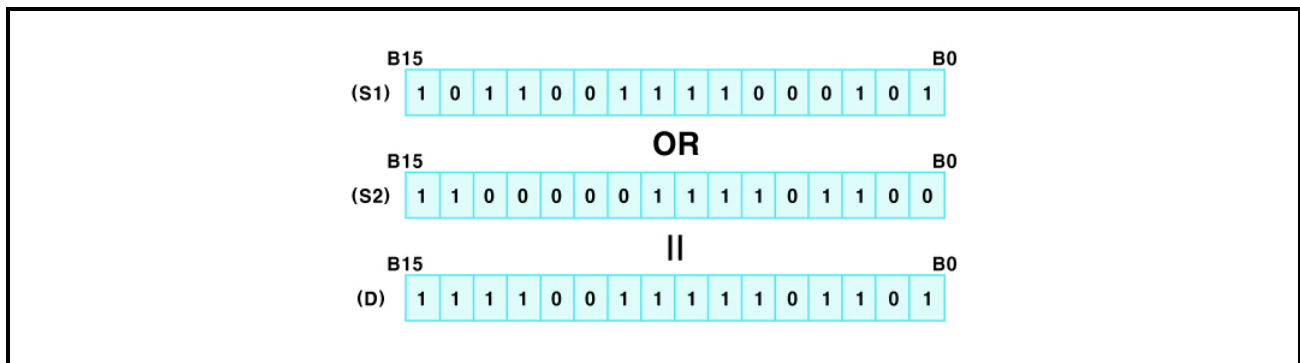



3.2.175 Logical operation instruction(DORL)

Logical operation instruction			DORL	S1	S2	D	N	Applicable model				
								LP-S044, LP-S070				
OP	DATA type	Available device / Description / Range					Error	Zero	Carry	Borrow	Step	
S1	DWORD	X, Y, F, Z, T, C, M, S, L, D, UW, integer						⊙			9	
		Data address to execute the 'OR' operation with S2										
		0(h0000) to 4294967295(hFFFFFFF)										
S2	DWORD	X, Y, F, Z, T, C, M, S, L, D, UW						⊙				
		Data address to execute the 'OR' operation with S1										
		0(h0000) to 4294967295(hFFFFFFF)										
D	DWORD	Y, F, Z, T, C, M, S, L, D, UW						⊙				
		Address to save the operation result										
		0(h0000) to 4294967295(hFFFFFFF)										
N	WORD	X, Y, F, Z, T, C, M, S, L, D, UW, integer						⊙				
		The number of S2 data address and saved address to execute the operation with S1										
		In the range within the corresponding device area of S2 and D										

<Ladder>

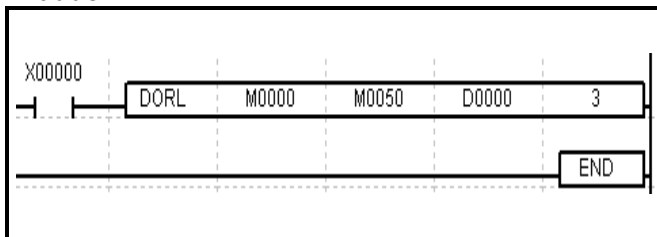

1. Executes the bitwise logical 'OR' operation for every bit of S1 double word and the number of N double words from S2 to S2(N-1) respectively and then stores the result into the number of N double words beginning with D double word.
2. If the result value is '0' double word, zero flag is SET.

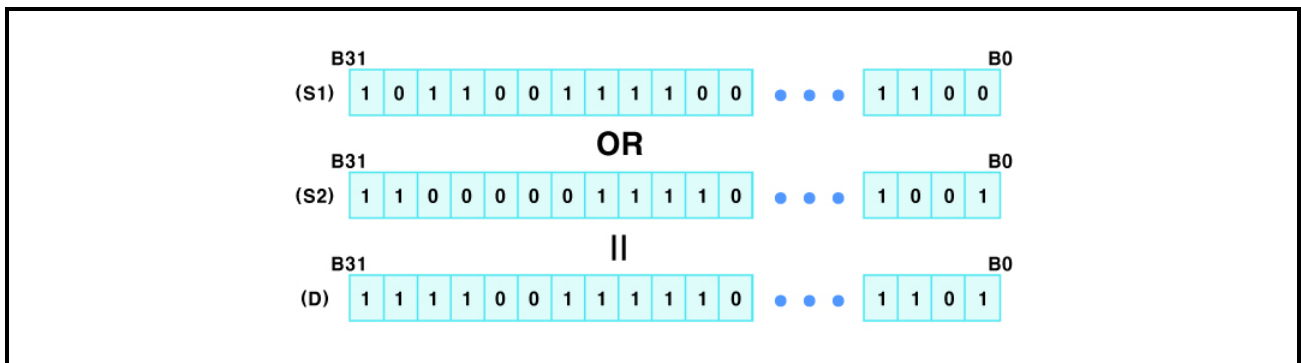



**3.2.177 Logical operation instruction(DXOR)**

Logical operation instruction			DXOR	S1	S2	D	Applicable model				
							LP-S044, LP-S070				
OP	DATA type	Available device / Description / Range					Error	Zero	Carry	Borrow	Step
S1	DWORD	X, Y, F, Z, T, C, M, S, L, D, UW, integer						Zero			7
		Data address to execute the 'XOR' operation with S2									
		0(h0000) to 4294967295(hFFFFFFF)									
S2	DWORD	X, Y, F, Z, T, C, M, S, L, D, UW, integer						Zero			7
		Data address to execute the 'XOR' operation with S1									
		0(h0000) to 4294967295(hFFFFFFF)									
D	DWORD	Y, F, Z, T, C, M, S, L, D, UW						Zero			7
		Address to save the operation result									
		0(h0000) to 4294967295(hFFFFFFF)									

<Ladder>

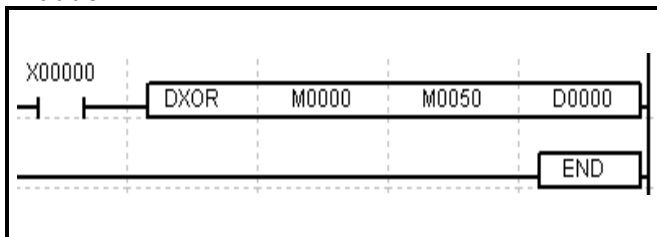

1. Executes the logical 'XOR' operation for every bit of S1 double word and the corresponding bit of S2 double word and then stores the result into the D double word.
2. If the result value is '0', zero flag is SET.

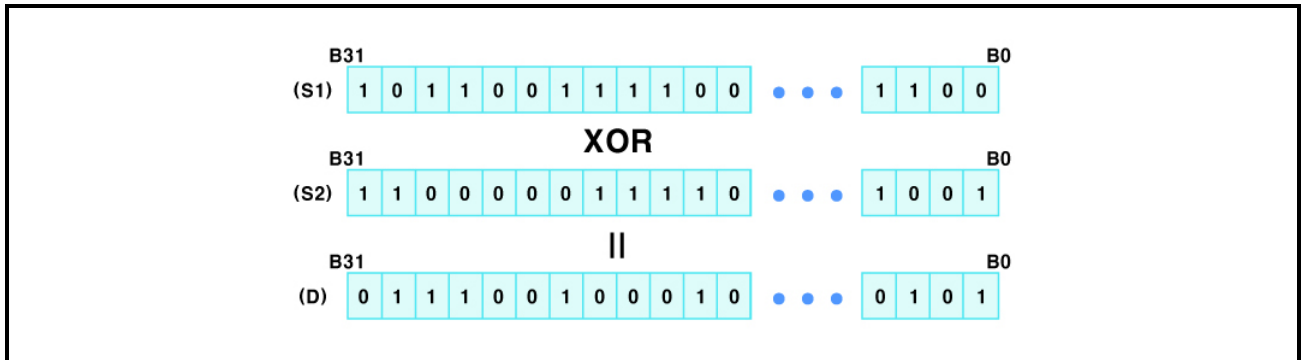

### 3.2.178 Logical operation instruction(AXOR)

OP	DATA type	Available device / Description / Range
S1	BIT	X, Y, F, T, C, M, UB
		Start address of the bit device to execute the 'XOR' operation with S2
		Not applicable
S2	BIT	X, Y, F, T, C, M, UB
		Start address of the bit device to execute the 'XOR' operation with S1
		Not applicable
D	BIT	Y, F, T, C, M, UB
		Address to save the operation result
		Not applicable
N	WORD	X, Y, F, Z, T, C, M, S, L, D, UW, integer
		The number of bit devices including the start address to execute the operation
		As many as the number of devices remained in S1, S2 and D area

Applicable model

LP-S044, LP-S070

Error	Zero	Carry	Borrow	Step
	◎			6

<Ladder>

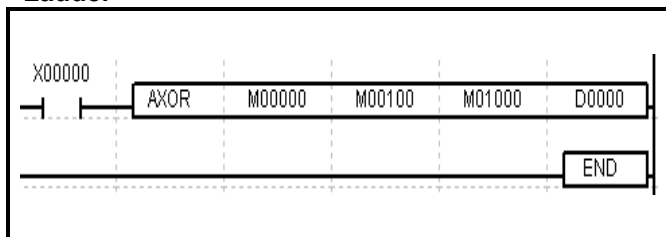

Executes the logical 'XOR' operation for the number of N bits from S1 to SN and the number of N bits from S2 to S2(N-1), bit by bit, and then stores the result into the number of N bits beginning with D destination bit.

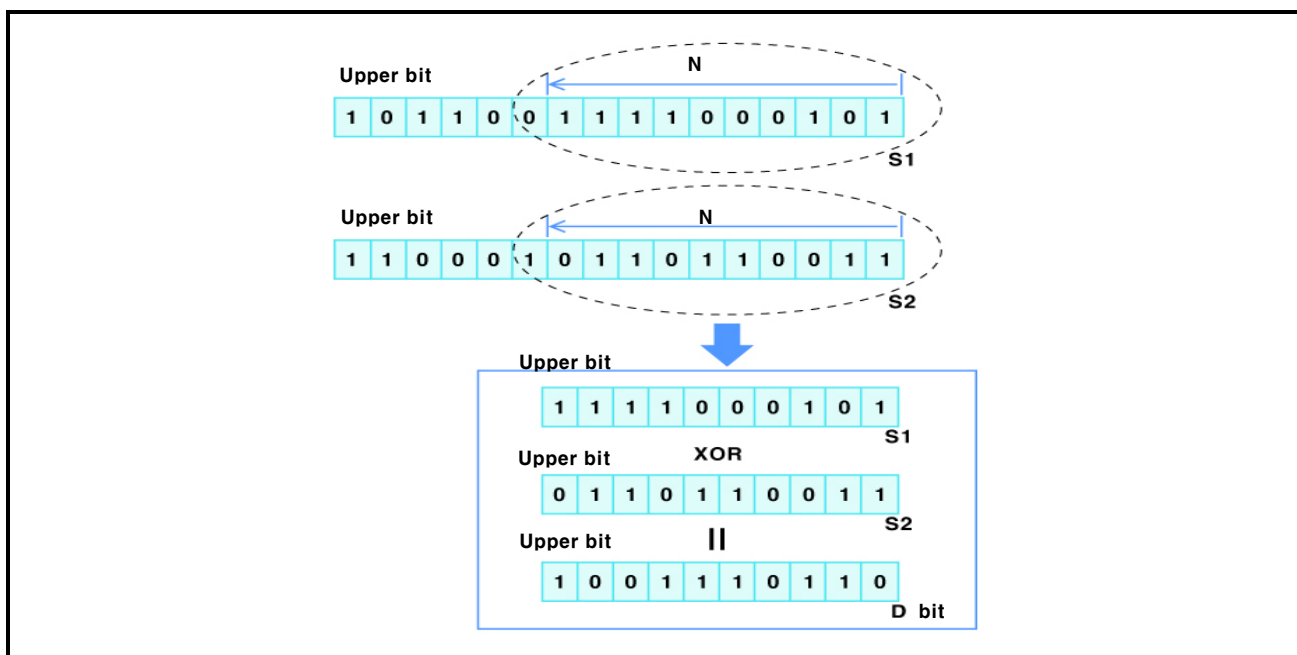

### 3.2.179 Logical operation instruction(XORL)

Logical operation instruction			XORL	S1	S2	D	N	Applicable model				
								LP-S044, LP-S070				
OP	DATA type	Available device / Description / Range						Error	Zero	Carry	Borrow	Step
S1	WORD	X, Y, F, Z, T, C, M, S, L, D, UW, integer							⊙			9
		Data address to execute the 'XOR' operation with S2										
		0(h0000) to 65535(hFFFF)										
S2	WORD	X, Y, F, Z, T, C, M, S, L, D, UW							⊙			9
		Data address to execute the 'XOR' operation with S1										
		0(h0000) to 65535(hFFFF)										
D	WORD	Y, F, Z, T, C, M, S, L, D, UW							⊙			9
		Address to save the operation result										
		0(h0000) to 65535(hFFFF)										
N	WORD	X, Y, F, Z, T, C, M, S, L, D, UW, integer							⊙			9
		The number of S2 data address and saved address to execute the operation with S1										
		In the range within the corresponding device area of S2 and D										

<Ladder>

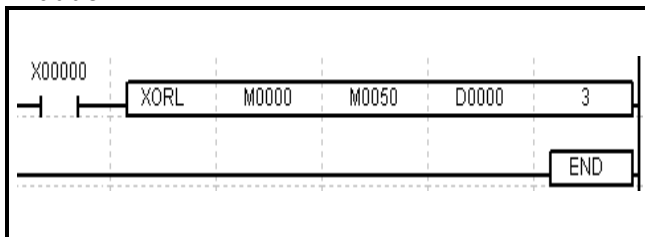

1. Executes the bitwise logical 'XOR' operation for every bit of S1 word and the number of N words, from S2 to S2(N-1), then stores the result into the number of N words beginning with D.
2. If the result value is '0' word, zero flag is SET.

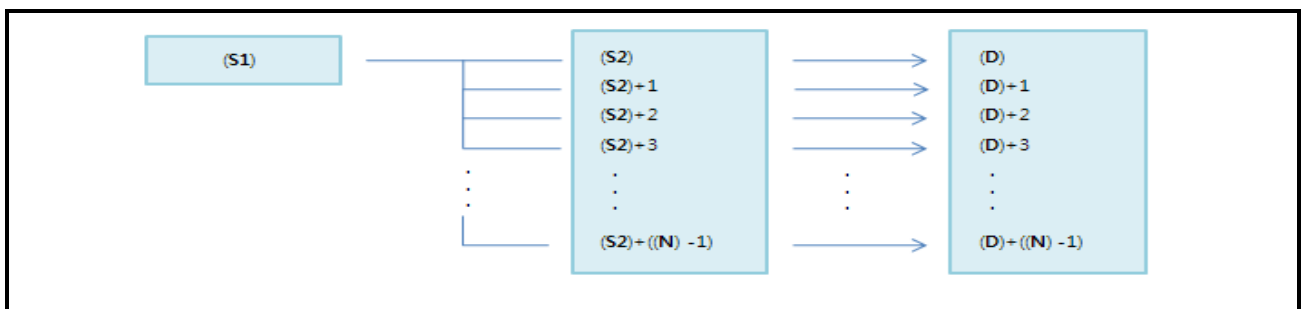
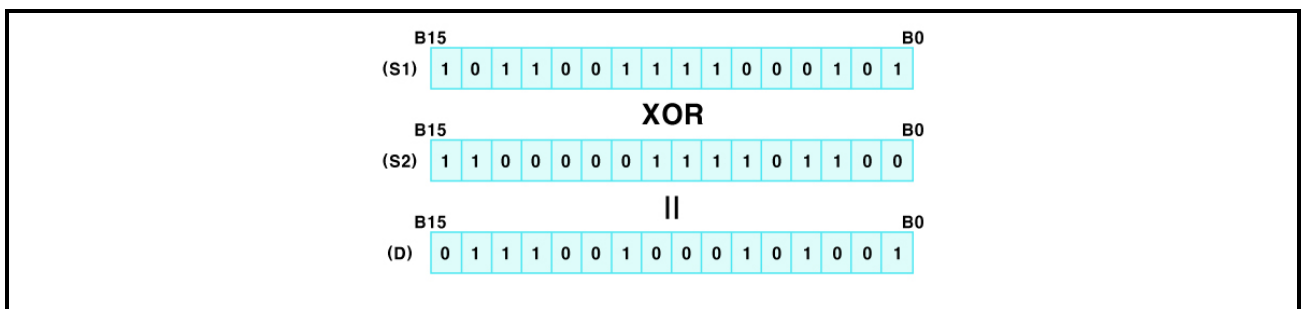

### 3.2.180 Logical operation instruction(DXORL)

Logical operation instruction		DXORL	S1	S2	D	N	Applicable model				
							LP-S044, LP-S070				
OP	DATA type	Available device / Description / Range					Error	Zero	Carry	Borrow	Step
S1	DWORD	X, Y, F, Z, T, C, M, S, L, D, UW, integer						Zero	Carry	Borrow	Step
		Data address to execute the 'XOR' operation with S2									
		0(h0000) to 4294967295(hFFFFFFF)									
S2	DWORD	X, Y, F, Z, T, C, M, S, L, D, UW						Zero	Carry	Borrow	Step
		Data address to execute the 'XOR' operation with S1									
		0(h0000) to 4294967295(hFFFFFFF)									
D	DWORD	Y, F, Z, T, C, M, S, L, D, UW						Zero	Carry	Borrow	Step
		Address to save the operation result									
		0(h0000) to 4294967295(hFFFFFFF)									
N	WORD	X, Y, F, Z, T, C, M, S, L, D, UW, integer						Zero	Carry	Borrow	Step
		The number of S2 data address and saved address to execute the operation with S1									
		In the range within the corresponding device area of S2 and D									

<Ladder>

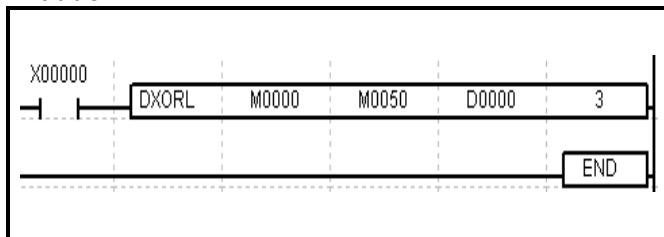

1. Executes the bitwise logical 'XOR' operation for every bit of S1 double word and the number of N double words from S2 to S2(N-1), and then stores the result into the number of N double words beginning with D.
2. If the result value is '0' double word, zero flag is SET.

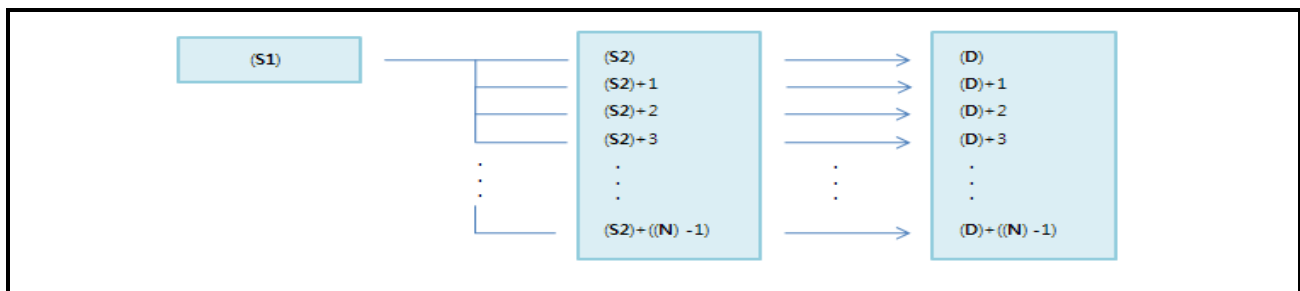
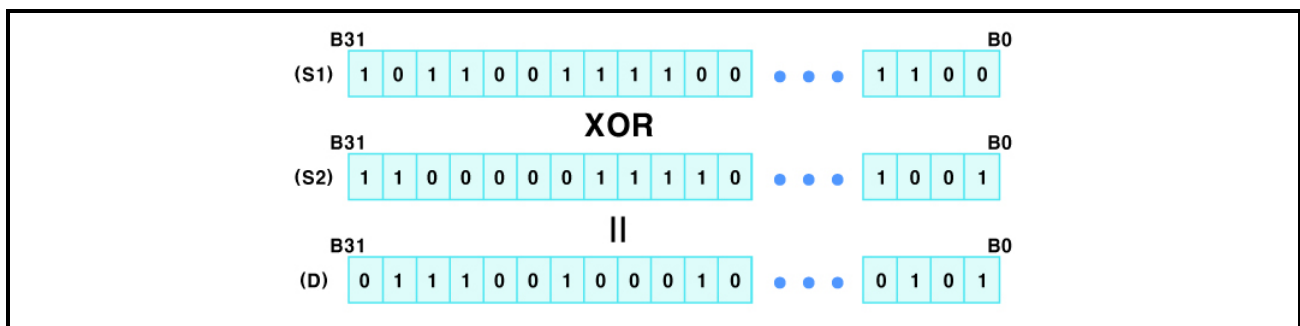

### 3.2.181 Logical operation instruction(XNR)

Logical operation instruction			XNR	S1	S2	D	Applicable model				
							LP-S044, LP-S070				
OP	DATA type	Available device / Description / Range					Error	Zero	Carry	Borrow	Step
S1	WORD	X, Y, F, Z, T, C, M, S, L, D, UW, integer					<input type="checkbox"/>	<input checked="" type="checkbox"/>	<input type="checkbox"/>	<input type="checkbox"/>	7
		Data address to execute the 'XNR' operation with S2									
		0(h0000) to 65535(hFFFF)									
S2	WORD	X, Y, F, Z, T, C, M, S, L, D, UW, integer					<input type="checkbox"/>	<input type="checkbox"/>	<input type="checkbox"/>	<input type="checkbox"/>	
		Data address to execute the 'XNR' operation with S1									
		0(h0000) to 65535(hFFFF)									
D	WORD	Y, F, Z, T, C, M, S, L, D, UW					<input type="checkbox"/>	<input type="checkbox"/>	<input type="checkbox"/>	<input type="checkbox"/>	
		Address to save the operation result									
		0(h0000) to 65535(hFFFF)									

<Ladder>

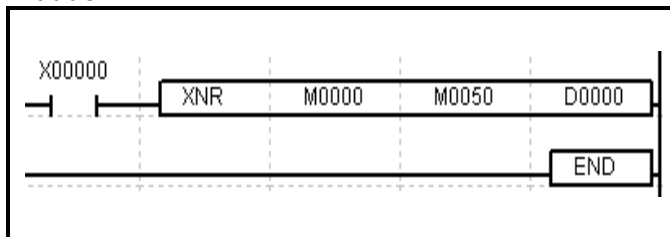

1. Executes the logical 'XNR' operation for every bit of S1 word and the corresponding bit of S2 word, bit by bit, and then stores the result into the D word.
2. If the result value is '0', zero flag is SET.

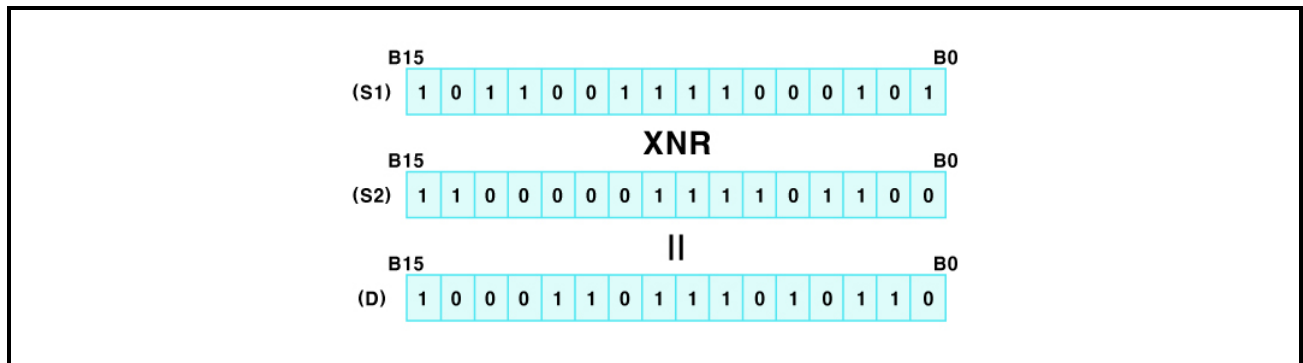

### 3.2.182 Logical operation instruction(DXNR)

Logical operation instruction		DXNR	S1	S2	D	Applicable model				
						LP-S044, LP-S070				
OP	DATA type	Available device / Description / Range				Error	Zero	Carry	Borrow	Step
S1	DWORD	X, Y, F, Z, T, C, M, S, L, D, UW, integer					Zero			7
		Data address to execute the 'XNR' operation with S2 0(h0000) to 4294967295(hFFFFFFFF)								
S2	DWORD	X, Y, F, Z, T, C, M, S, L, D, UW, integer					Zero			7
		Data address to execute the 'XNR' operation with S1 0(h0000) to 4294967295(hFFFFFFFF)								
D	DWORD	Y, F, Z, T, C, M, S, L, D, UW					Zero			7
		Address to save the operation result 0(h0000) to 4294967295(hFFFFFFFF)								

<Ladder>

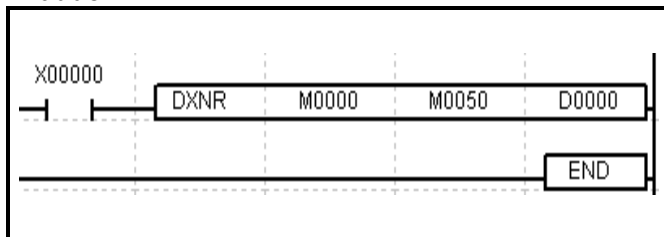

1. Executes the logical 'XNR' operation for every bit of S1 double word and the corresponding bit of S2 double word, and then stores the result into the D double word.
2. If the result value is '0', zero flag is SET.

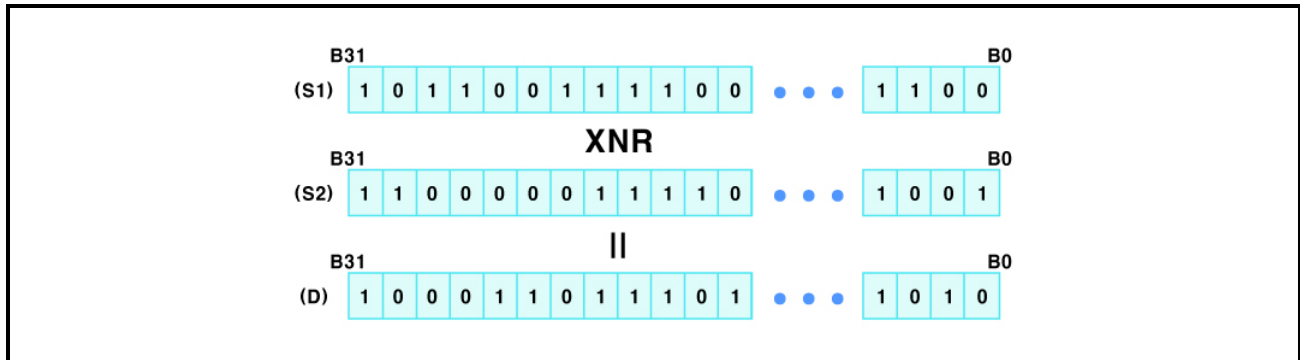



3.2.183 Logical operation instruction (AXNR)

Logical operation instruction			AXNR	S1	S2	D	N	Applicable model				
								LP-S044, LP-S070				
OP	DATA type	Available device / Description / Range						Error	Zero	Carry	Borrow	Step
S1	BIT	X, Y, F, T, C, M, UB							⊙			9
		Start address of the bit device to execute the 'XNR' operation with S2										
		Not applicable										
S2	BIT	X, Y, F, T, C, M, UB							⊙			9
		Start address of the bit device to execute the 'XNR' operation with S1										
		Not applicable										
D	BIT	Y, F, T, C, M, UB							⊙			9
		Start address of the bit device to save the operation result										
		Not applicable										
N	WORD	X, Y, F, Z, T, C, M, S, L, D, UW, integer							⊙			9
		The number of bit devices to execute the operation including the start address										
		As many as the number of devices remained in the corresponding S1, S2, and D area										

<Ladder>

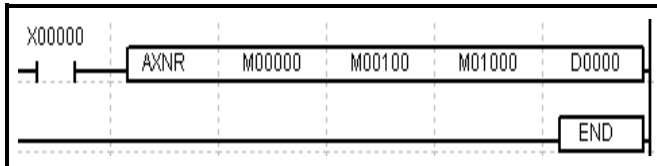

Executes the logical 'XNR' operation for the number of N bits from S1 to SN and the number of N bits from S2 to S2(N-1), and then stores the result into the number of N bits beginning with D destination bit.

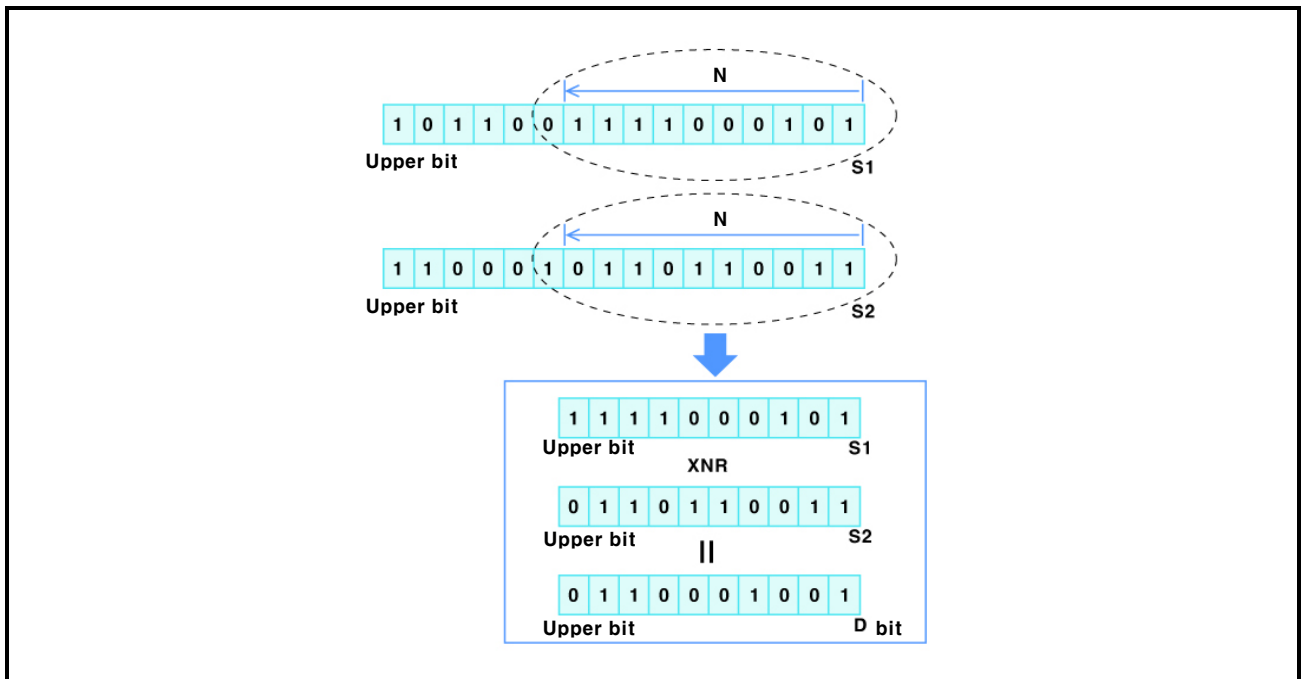

### 3.2.184 Logical operation instruction(XNRL)

Logical operation instruction		XNRL	S1	S2	D	N	Applicable model				
							LP-S044, LP-S070				
OP	DATA type	Available device / Description / Range					Error	Zero	Carry	Borrow	Step
S1	WORD	X, Y, F, Z, T, C, M, S, L, D, UW, integer					<input type="checkbox"/>	<input type="checkbox"/>	<input type="checkbox"/>	<input type="checkbox"/>	9
		Data address to execute the 'XNR' operation with S2									
		0(h0000) to 65535(hFFFF)									
S2	WORD	X, Y, F, Z, T, C, M, S, L, D, UW					<input type="checkbox"/>	<input checked="" type="checkbox"/>	<input type="checkbox"/>	<input type="checkbox"/>	
		Data address to execute the 'XNR' operation with S1									
		0(h0000) to 65535(hFFFF)									
D	WORD	Y, F, Z, T, C, M, S, L, D, UW					<input type="checkbox"/>	<input type="checkbox"/>	<input type="checkbox"/>	<input type="checkbox"/>	
		Address to save the operation result									
		0(h0000) to 65535(hFFFF)									
N	WORD	X, Y, F, Z, T, C, M, S, L, D, UW, integer					<input type="checkbox"/>	<input type="checkbox"/>	<input type="checkbox"/>	<input type="checkbox"/>	
		The number of S2 data address and saved address to execute the operation with S1									
		In the range within the corresponding device area of S2 and D									

<Ladder>

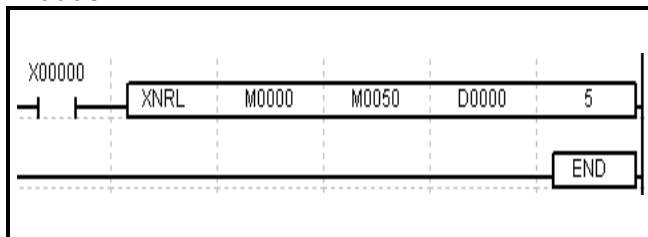

1. Executes the bitwise logical 'XNR' operation for every bit of S1 word and the number of N words from S2 to S2(N-1) bit by bit, and then stores the result into the number of N words from D word.
2. If the result value is '0' word, zero flag is SET.

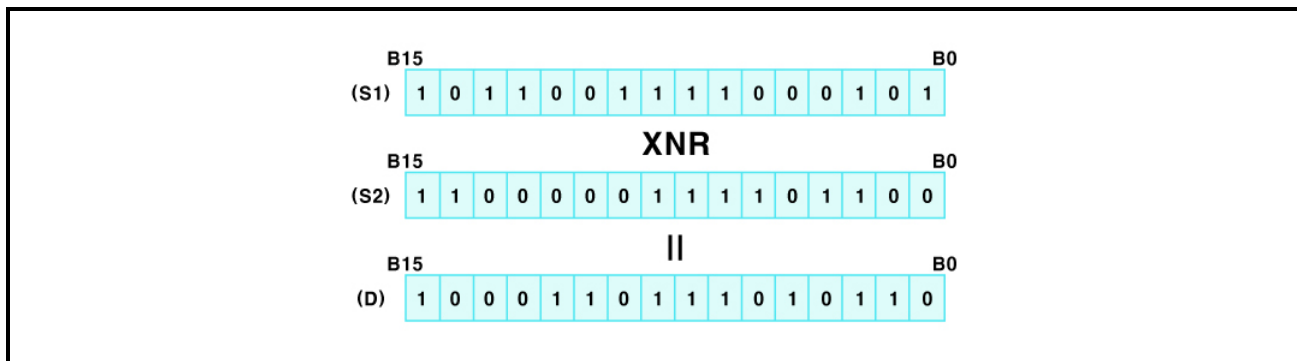

3.2.185 Logical operation instruction(DXNRL)

Logical operation instruction		DXNRL	S1	S2	D	N	Applicable model				
							LP-S044, LP-S070				
OP	DATA type	Available device / Description / Range					Error	Zero	Carry	Borrow	Step
S1	DWORD	X, Y, F, Z, T, C, M, S, L, D, UW, integer						☉			9
		Data address to execute the 'XNR' operation with S2 0(h0000) to 4294967295(hFFFFFFF)									
S2	DWORD	X, Y, F, Z, T, C, M, S, L, D, UW									
		Data address to execute the 'XNR' operation with S1 0(h0000) to 4294967295(hFFFFFFF)									
D	DWORD	Y, F, Z, T, C, M, S, L, D, UW									
		Address to save the operation result 0(h0000) to 4294967295(hFFFFFFF)									
N	WORD	X, Y, F, Z, T, C, M, S, L, D, UW, integer									
		The number of S2 data address and saved address to execute the operation with S1 In the range within the corresponding device area of S2 and D									

<Ladder>

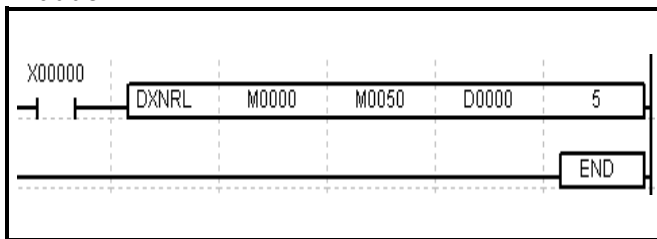

1. Executes the logical 'XNR' operation for every bit of S1 double word and the number of N double words from S2 to S2(N-1), bit by bit, and then stores the result into the number of N double words beginning with D.
2. If the result value is '0' double word, zero flag is SET.

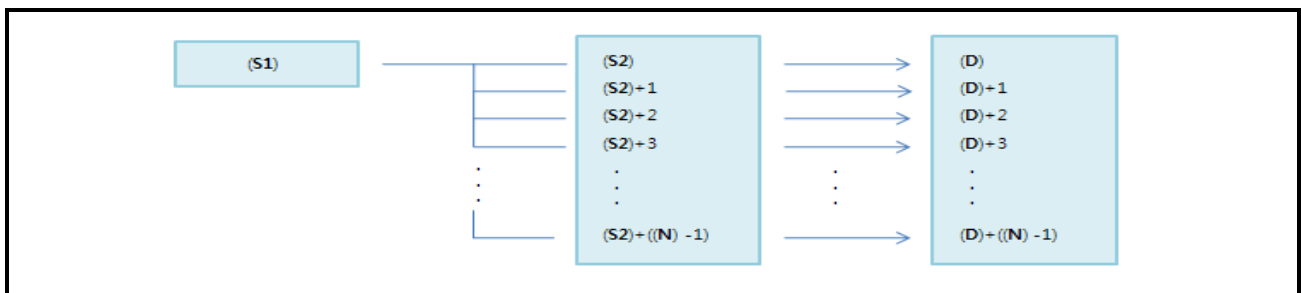
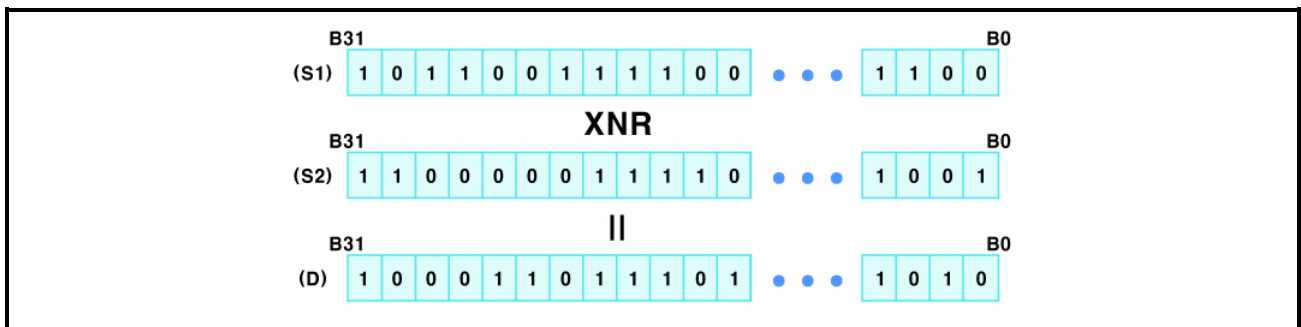

**3.2.186 BIN/BCD conversion instruction(BIN2BCD)**

<b>BIN/BCD conversion instruction</b>			<b>BIN2BCD</b>	<b>S</b>	<b>D</b>	Applicable model LP-S044, LP-S070				
OP	DATA type	Available device / Description / Range			Error	Zero	Carry	Borrow	Step	
<b>S</b>	WORD	X, Y, F, Z, T, C, M, S, L, D, UW, integer			<input type="checkbox"/>	<input type="checkbox"/>	<input type="checkbox"/>	<input type="checkbox"/>	<input type="checkbox"/>	
		Device number which has to be transmitted data or data 0 to 9999(h0000 to h270F)								
<b>D</b>	WORD	Y, F, Z, T, C, M, S, L, D, UW			<input checked="" type="checkbox"/>	<input type="checkbox"/>	<input type="checkbox"/>	<input type="checkbox"/>	5	
		Device address to save converted data h0000 to h9999								

<Ladder>

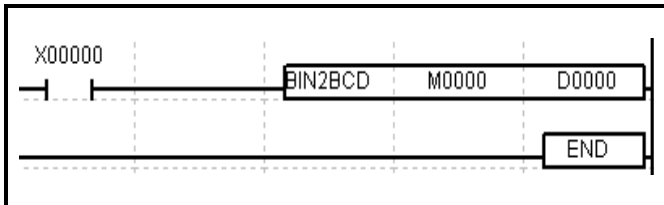

1. Converts the BINARY data (0 to h270F) stored in S device into the BCD data and then stores the result into the D word.
2. If the converted value is out of the range between 0 to 9999(BIN data 0 to h270F), error flag is SET.

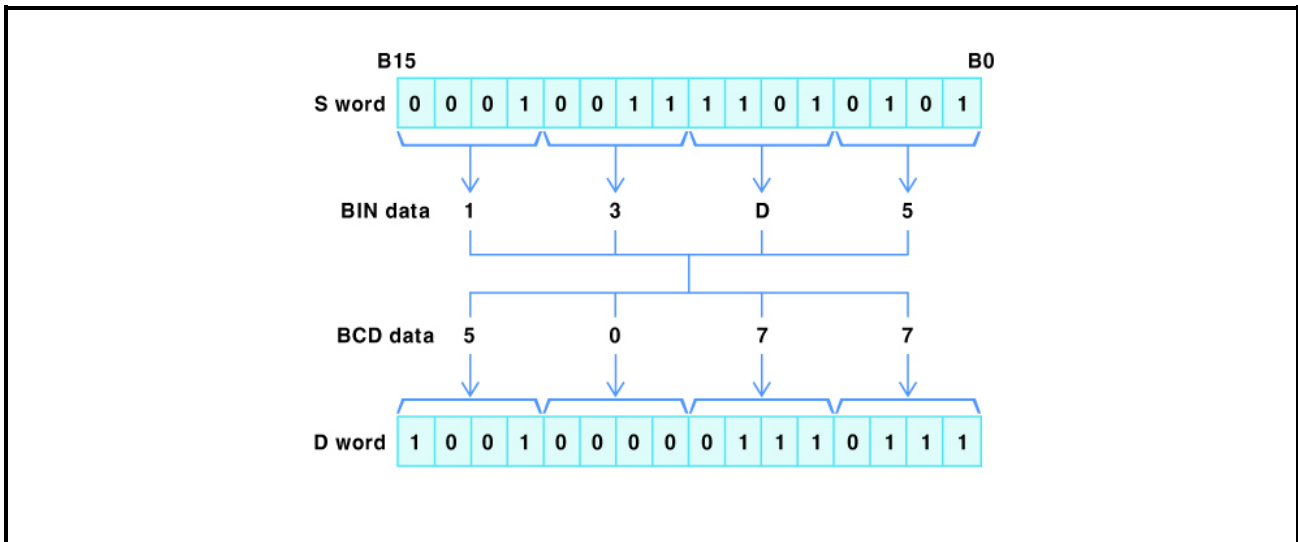

### 3.2.187 BIN/BCD conversion instruction(DBIN2BCD)

<b>BIN/BCD conversion instruction</b>			<b>DBIN2BCD</b>	<b>S</b>	<b>D</b>	Applicable model LP-S044, LP-S070				
OP	DATA type	Available device / Description / Range				Error	Zero	Carry	Borrow	Step
<b>S</b>	DWORD	X, Y, F, Z, T, C, M, S, L, D, UW, integer				☉				5
		Device number which has to be transmitted data or data 0 to 99999999(h00000000 to h05F5E0FF)								
<b>D</b>	DWORD	Y, F, Z, T, C, M, S, L, D, UW								
		Device address to save converted data h00000000 to h99999999								

<Ladder>

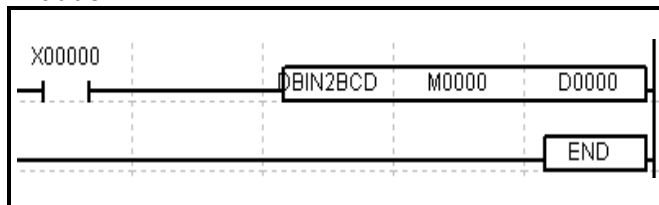

1. Converts the BINARY data (0 to h05F5E0FF) stored in S double word into the BCD data, and then stores the result into the D double word.
2. If the converted value is out of the range from 0 to 99999999(BIN data 0 to h05F5E0FF), error flag is SET.

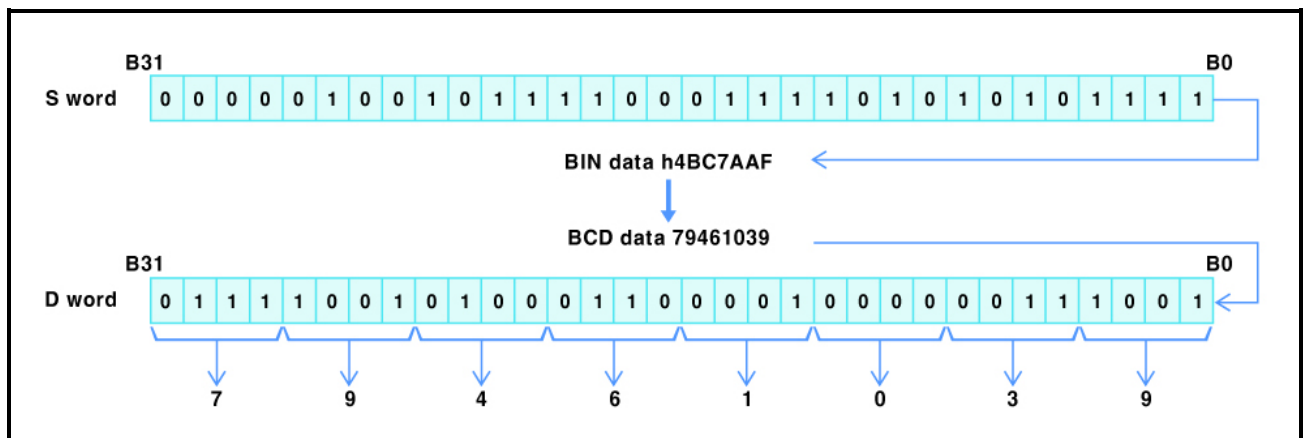

### 3.2.188 BIN/BCD conversion instruction(BCD2BIN)

<b>BIN/BCD conversion instruction</b>			<b>BCD2BIN</b>	<b>S</b>	<b>D</b>	Applicable model LP-S044, LP-S070				
OP	DATA type	Available device / Description / Range				Error	Zero	Carry	Borrow	Step
<b>S</b>	WORD	X, Y, M, S, T, C, D, Z, F, UW, integer				☉				5
		Device address which saves BCD data to be converted as BIN value h0000 to h9999								
<b>D</b>	WORD	Y, M, S, T, C, D, Z, F, UW								
		Device address to save converted data 0 to 9999(h0000 to h270F)								

<Ladder>

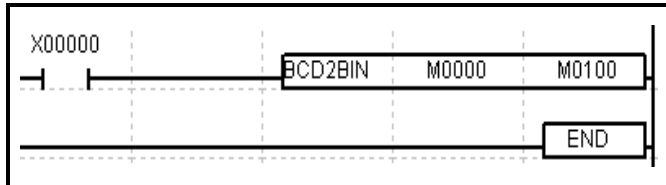

1. Converts the BCD code (0 to 9999) stored in S word into the BINARY data, and then stores the result into the D word.
2. If the S word is not the BCD code, error flag is SET.

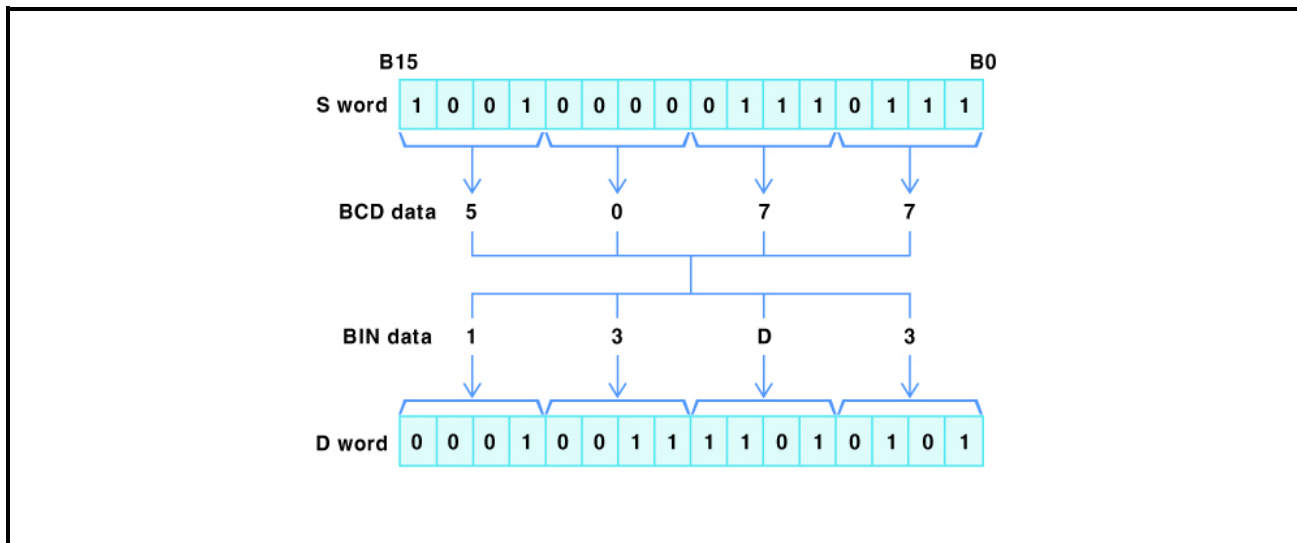

### 3.2.189 BIN/BCD conversion instruction(DBCD2BIN)

<b>BIN/BCD conversion instruction</b>			<b>DBCD2BIN</b>	<b>S</b>	<b>D</b>	Applicable model LP-S044, LP-S070				
OP	DATA type	Available device / Description / Range			Error	Zero	Carry	Borrow	Step	
S	DWORD	X, Y, M, S, T, C, D, Z, F, UW, integer			☉	☐	☐	☐	5	
		Device address which saves BCD data to be converted as BIN value h00000000 to h99999999								
D	DWORD	Y, M, S, T, C, D, Z, F, UW								
		Device address to save converted data 0 to 99999999(h00000000 to h05F5E0FF)								

<Ladder>

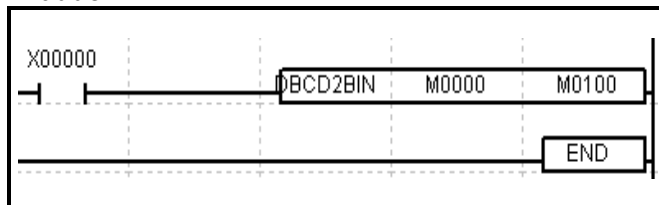

1. Converts the BCD data stored in S double word into the BINARY data, and then stores the result into the D double word.
2. If the S double word is not the BCD code, error flag is SET.

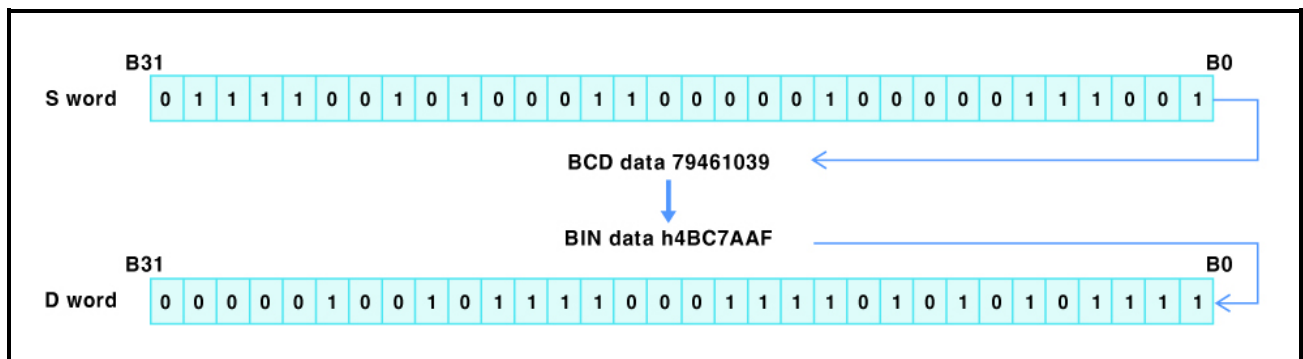

### 3.2.190 String conversion instruction(BIN2HASC)

String conversion instruction			Applicable model				
BIN2HASC S D			LP-S044, LP-S070				
OP	DATA type	Available device / Description / Range	Error	Zero	Carry	Borrow	Step
S	WORD	X, Y, M, S, T, C, D, Z, F, UW, integer					5
		Device address which saves to be converted data as ASCII value h0000 to hFFFF					
D	WORD	Y, M, S, T, C, D, Z, F, UW					
		Device address to save converted data Allowable range per byte(h30 to h39, h41 to h46)					

<Ladder>

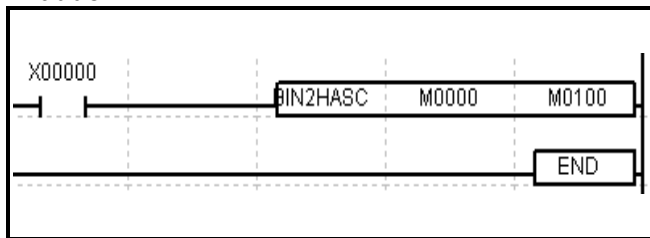

1. Converts the BINARY data stored in S word into the HEX ASCII one by one in order from the upper order value.
2. The converted value is sequentially stored in D double word beginning with D, by 2 digits per word.
3. The operation range is 'h0000 to hFFFF'.

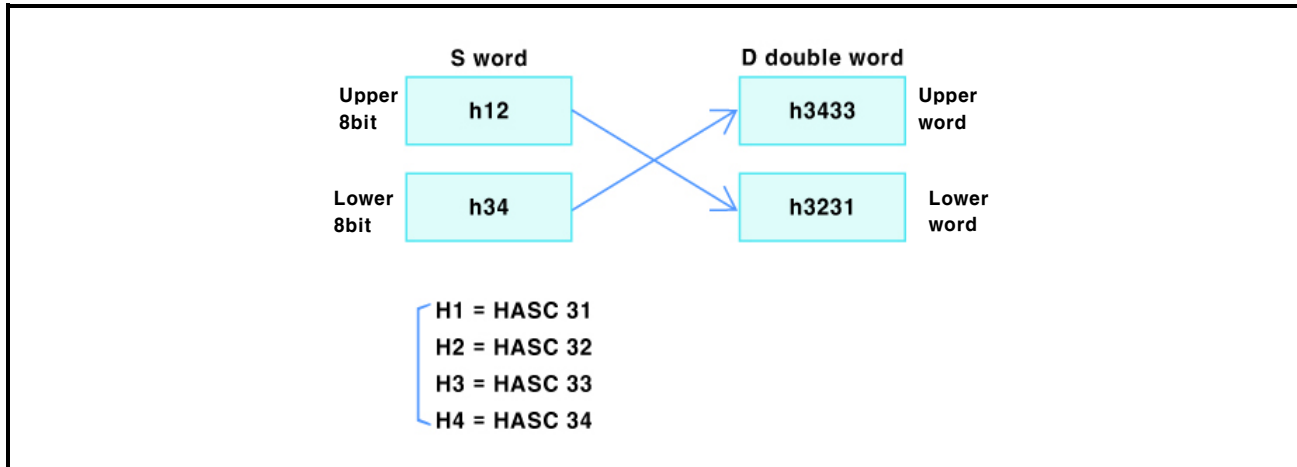



### 3.2.191 String conversion instruction(DBIN2HASC)

<p><b>String conversion instruction</b>    <b>DBIN2HASC</b>    <b>S</b>    <b>D</b></p>			<p>Applicable model LP-S044, LP-S070</p>				
OP	DATA type	Available device / Description / Range	Error	Zero	Carry	Borrow	Step
<b>S</b>	DWORD	X, Y, M, S, T, C, D, Z, F, UW, integer					5
		Device address which saves to be converted data as ASCII value h00000000 to hFFFFFFF					
<b>D</b>	QWORD	Y, M, S, T, C, D, Z, F, UW					
		Device address to save converted data Allowable range per byte (h30 to h39, h41 to h46)					

<Ladder>

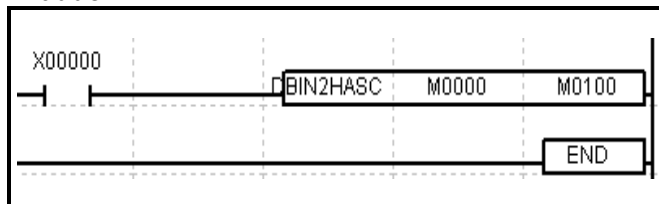

1. Converts the BINARY data stored in S double word into the HEX ASCII one by one in order from the upper order value.
2. The converted value is sequentially stored in D quad word beginning with D, by 2 digits per word.
3. The operation range is h00000000 to HFFFFFFF.

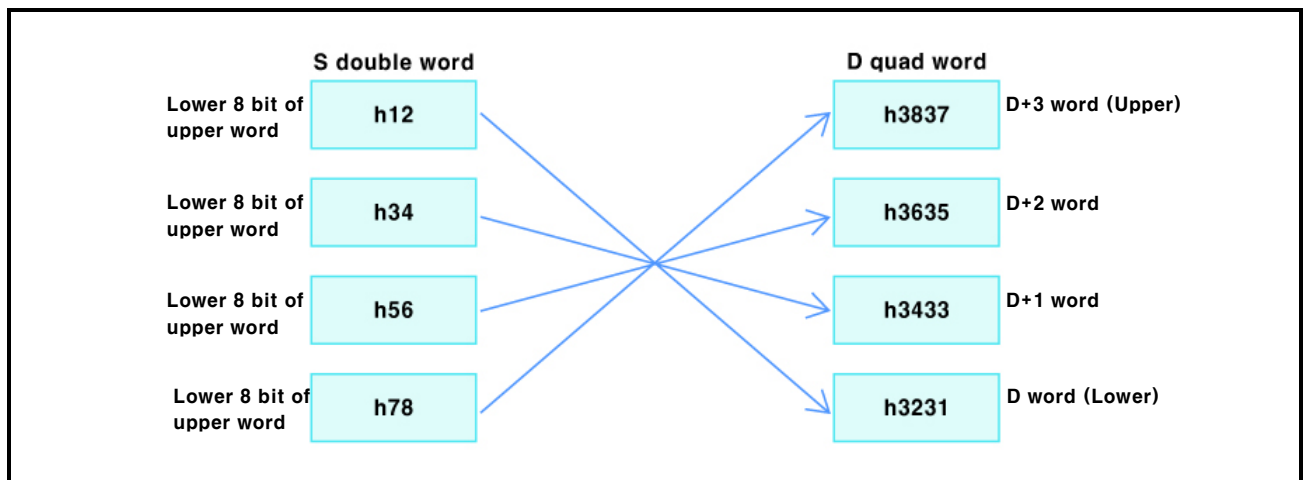

### 3.2.192 String conversion instruction(HASC2BIN)

String conversion instruction		<b>HASC2BIN</b>	<b>S</b>	<b>D</b>	Applicable model LP-S044, LP-S070				
OP	DATA type	Available device / Description / Range			Error	Zero	Carry	Borrow	Step
<b>S</b>	WORD	X, Y, M, S, T, C, D, Z, F, UW			☉				5
		Device address which saves HEX ASCII value to be converted data as BIN value							
		Allowable range per byte (h30 to h39, h41 to h46)							
<b>D</b>	WORD	Y, M, S, T, C, D, Z, F, UW							
		Device address to save converted data							
		h0000 to hFFFF							

<Ladder>

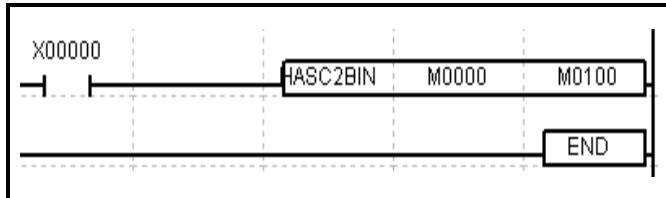

1. Recognizes the double word value of S as ASCII and stores the corresponding value into the D word.
2. If the converted value is not the HEX ASCII, error bit (F34) is SET. (h30 to h39, h41 to h46)

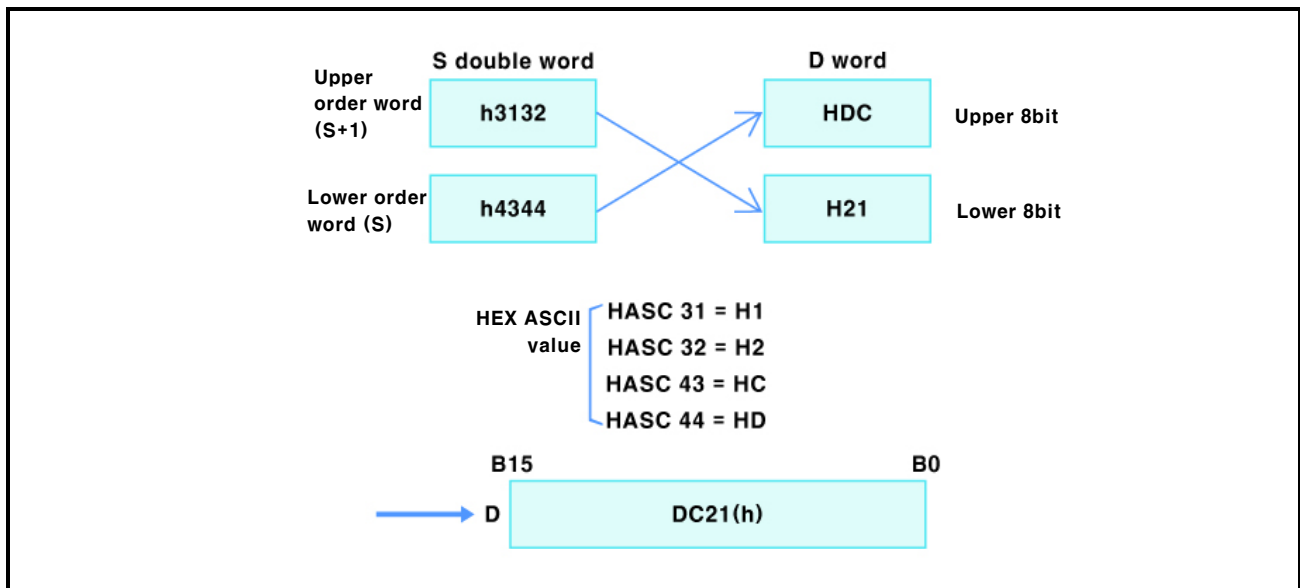

### 3.2.193 String conversion instruction(DHASC2BIN)

<b>String conversion instruction</b>			<b>DHASC2BIN</b>	<b>S</b>	<b>D</b>	Applicable model LP-S044, LP-S070					
OP	DATA type	Available device / Description / Range				Error	Zero	Carry	Borrow	Step	
<b>S</b>	DWORD	X, Y, M, S, T, C, D, Z, F, UW				☉	☐	☐	☐	☐	5
		Device address which saves HEX ASCII value to be converted data as BIN value									
		Allowable range per byte (h30 to h39, h41 to h46)									
<b>D</b>	DWORD	Y, M, S, T, C, D, Z, F, UW				☐	☐	☐	☐	☐	
		Device address to save converted data									
		h00000000 to hFFFFFFF									

<Ladder>

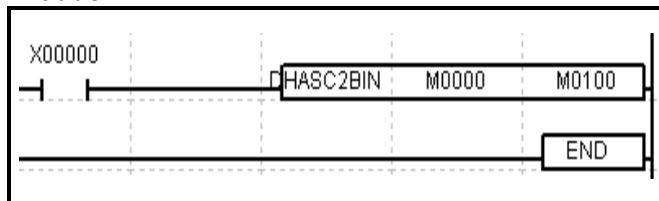

1. Recognizes the quad word value of S as ASCII and stores the corresponding value into the D double word.
2. If the converted value is not the HEX ASCII, error bit (F34) is SET. (h30 to h39, h41 to h46)

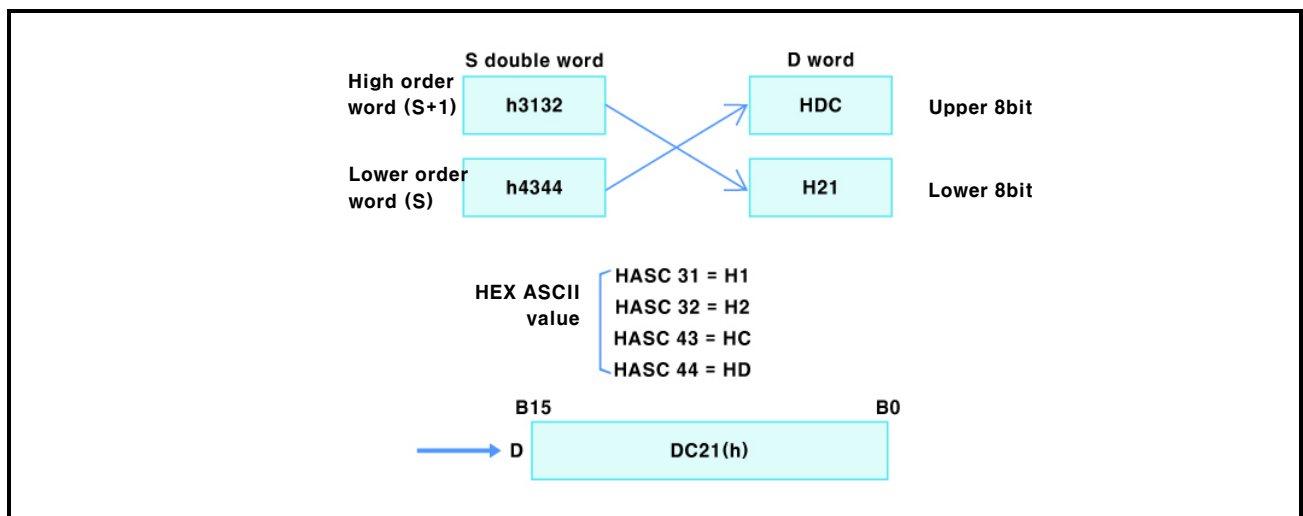

### 3.2.194 String conversion instruction(BCD2DASC)

<p><b>String conversion instruction</b>    <b>BCD2DASC</b>    <b>S</b>    <b>D</b></p>			<p>Applicable model LP-S044, LP-S070</p>				
OP	DATA type	Available device / Description / Range	Error	Zero	Carry	Borrow	Step
<b>S</b>	WORD	X, Y, M, S, T, C, D, Z, F, UW, integer	☉				5
		Device address which saves the data to be converted data as ASCII value					
		h0000 to hFFFF					
<b>D</b>	DWORD	Y, M, S, T, C, D, Z, F, UW					
		Device address to save converted data					
		Allowable range per byte (h30 to h39, h41 to h46)					

<Ladder>

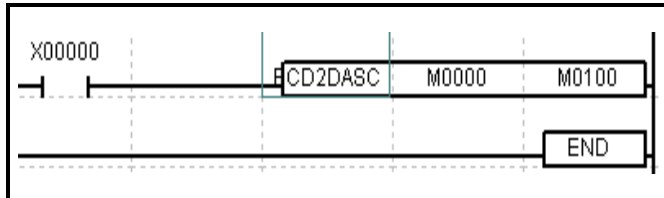

1. Recognizes BCD data stored in S word as decimal number, converts each digit into the ASCII value and then stores them sequentially into the D double word.
2. The operation range is 'h0000 to h9999'.
3. If the S word is not the BCD code, error flag is SET.

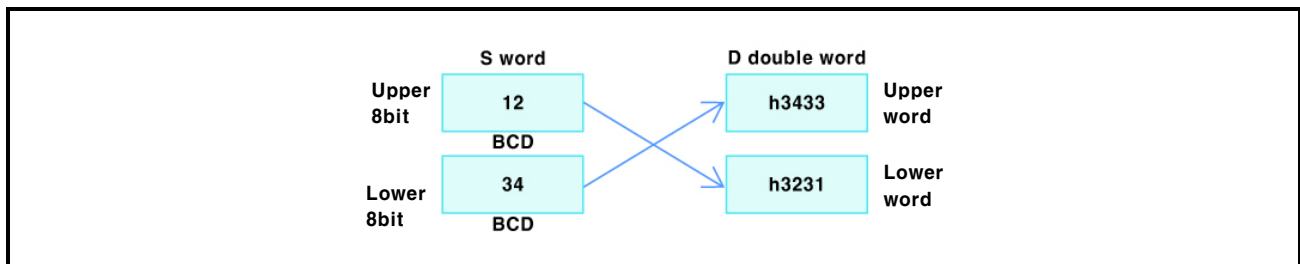

### 3.2.195 String conversion instruction(DBCD2DASC)

<p><b>String conversion instruction</b></p> <p><b>DBCD2DASC S D</b></p>			<p>Applicable model</p> <p>LP-S044, LP-S070</p>				
OP	DATA type	Available device / Description / Range	Error	Zero	Carry	Borrow	Step
S	DWORD	X, Y, M, S, T, C, D, Z, F, UW, integer	☐	☐	☐	☐	☐
		Device address which saves the BCD data to be converted data as ASCII value					
D	QWORD	h00000000 to h999999999	☐	☐	☐	☐	5
		Y, M, S, T, C, D, Z, F, UW					
		Device address to save converted data					
		Allowable range per byte (h30 to h39, h41 to h46)					

<Ladder>

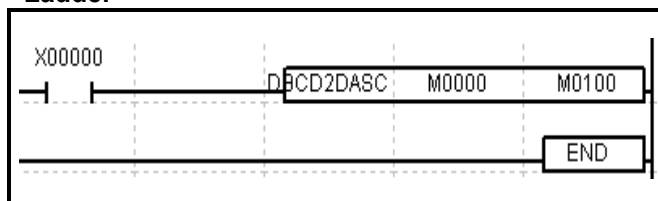

1. Recognizes BCD data stored in S double word as decimal number, converts each digit into the ASCII value and then stores them sequentially into the D word.
2. The operation range is h00000000 to h999999999.
3. If the S word is not the BCD code, error flag is SET.

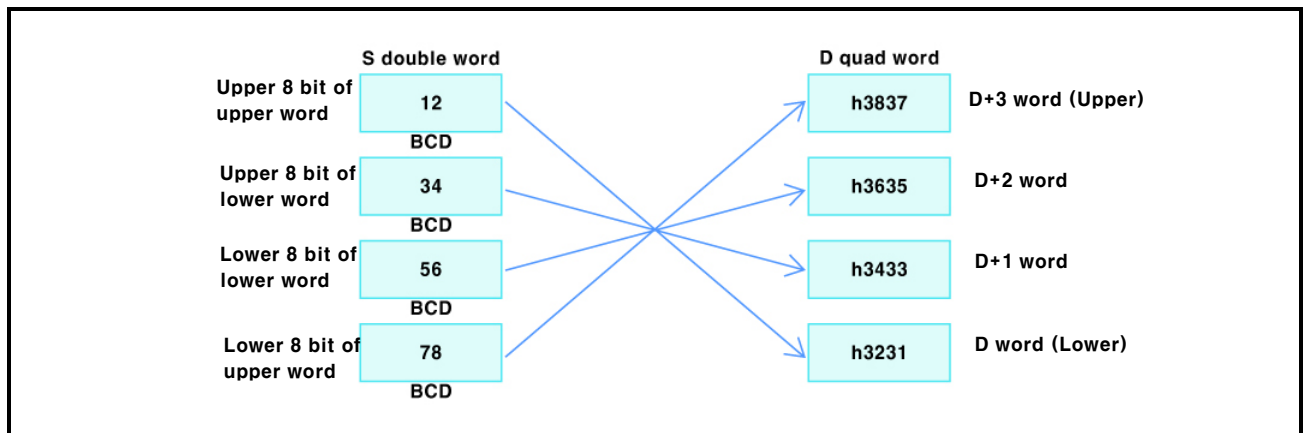

### 3.2.196 String conversion instruction(DASC2BIN)

String conversion instruction		DASC2BIN	S	D	Applicable model LP-S044, LP-S070				
OP	DATA type	Available device / Description / Range			Error	Zero	Carry	Borrow	Step
S	WORD	X, Y, M, S, T, C, D, Z, F, UW			☉				5
		Device address which saves the Dec ASCII data to be converted as BIN value							
		h30 to h39 per byte except sign bit (h2D, h28)							
D	WORD	Y, M, S, T, C, D, Z, F, UW							
		Device address to save converted data							
		-32768(h8000) to 32767(h7FFF)							

<Ladder>

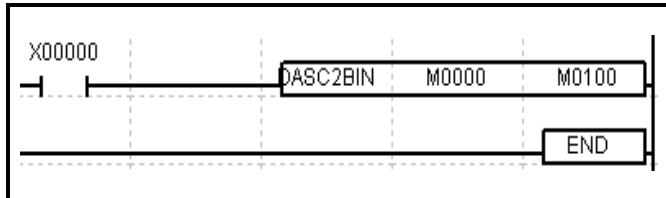

1. Recognizes the ASCII data stored in S word as decimal number, convert each digit into the BINARY value, and then stores them into the D word.
2. The lower order byte of the first source word determines the sign of the BINARY value.
3. The sign value is +(H2B), -(H2D).
4. If the sign value is positive, it can be omitted.
5. The D word is stored as Signed.
6. The operation range is -32768(h8000) to 32767(h7FFF).
7. If the S word is not in the valid ASCII(h30 to h39) range, corresponding to 0 to 9, error bit (F34) is SET.

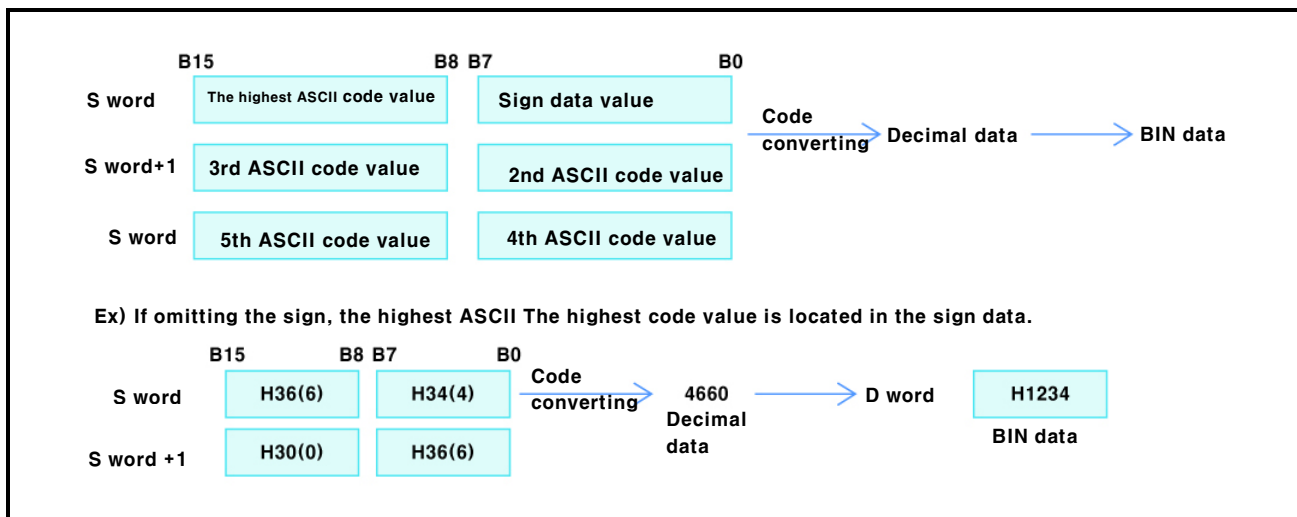

### 3.2.197 String conversion instruction(DDASC2BIN)

<p><b>String conversion instruction</b></p> <p><b>DDASC2BIN S D</b></p>			<p>Applicable model</p> <p>LP-S044, LP-S070</p>				
OP	DATA type	Available device / Description / Range	Error	Zero	Carry	Borrow	Step
S	WORD	X, Y, M, S, T, C, D, Z, F, UW, integer	☉				5
		Device address which saves the Dec ASCII data to be converted as BIN value					
		h30 to h39 per byte except sign bit (h2D, h28)					
D	DINT	Y, M, S, T, C, D, Z, F, UW					
		Device address to save converted data					
		-2147483648(h80000000) to 2147483647(h7FFFFFFF)					

<Ladder>

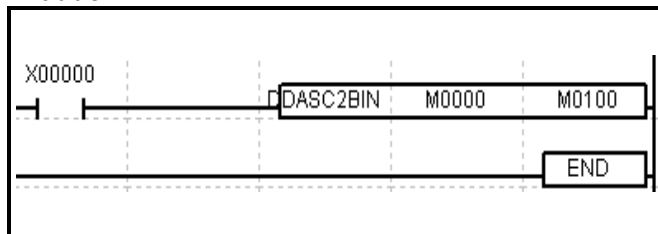

1. Recognizes the ASCII data stored in S word as decimal number and convert each digit into the BINARY value then stores them into the D word.
2. The lower order byte of the first source word determines the sign of the BINARY value.
3. The sign value is +(H2B), -(H2D).
4. If the sign value is positive, it can be omitted.
5. The D word is stored as Signed.
6. The operation range is -2147483648 (h80000000) to 2147483647 (h7FFFFFFF).
7. If the S word is not in the valid ASCII(h30 to h39) range, corresponding to 0 to 9, error bit (F34) is SET.

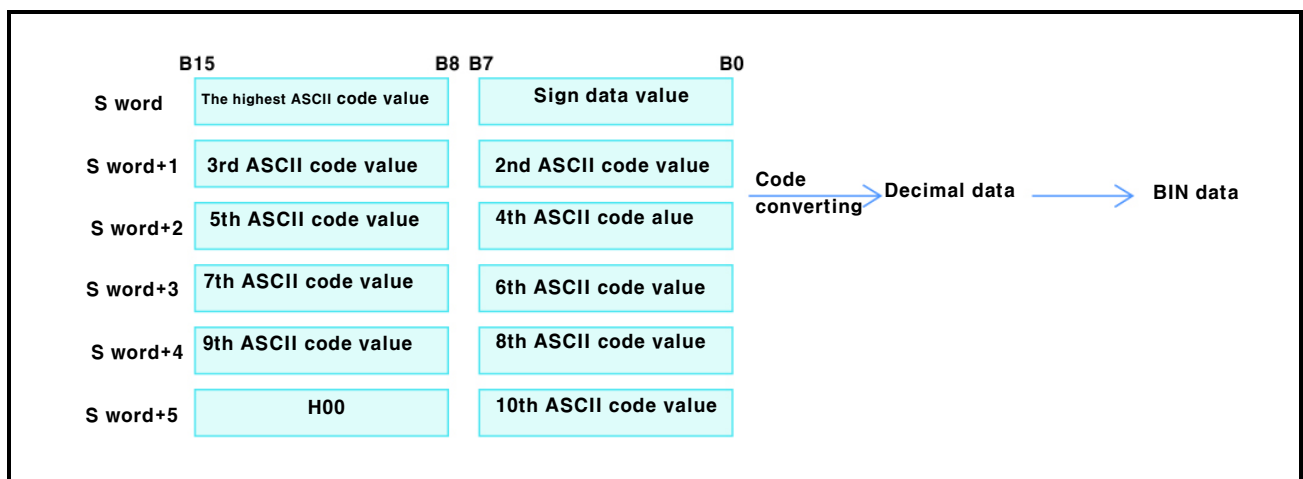

### 3.2.198 String conversion instruction(STR2ASC)

<p><b>String conversion instruction</b></p>			<p><b>STR2ASC</b></p>	<p><b>S</b></p>	<p><b>D</b></p>	<p>Applicable model</p> <p>LP-S044, LP-S070</p>				
OP	DATA type	Available device / Description / Range				Error	Zero	Carry	Borrow	Step
<b>S</b>	STRING	STRING								7
		STRING data to convert as ASCII value								
		String								
<b>D</b>	WORD	Y, M, S, T, C, D, Z, F, UW								
		Device address to save converted data								
		ASCII value								

<Ladder>

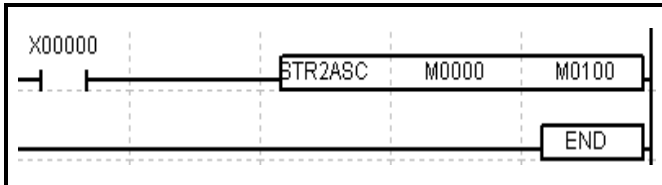

1. Converts STRING into the ASCII and then stores it sequentially into the D.
2. It is available to input up to 128 characters.

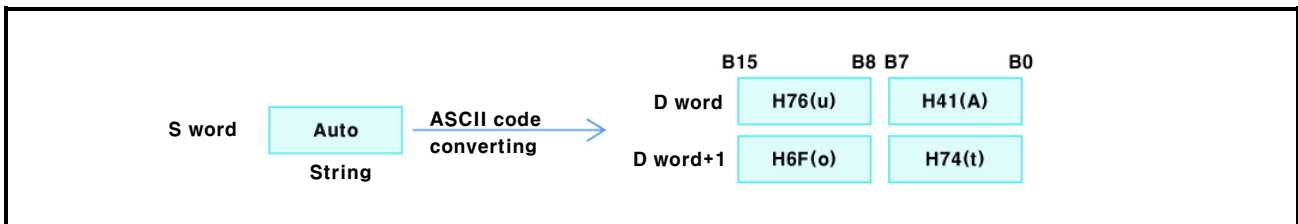



### 3.2.199 String conversion instruction(DASC2BCD)

<p>String conversion instruction</p> <p><b>DASC2BCD</b>    <b>S</b>    <b>D</b></p>			<p>Applicable model</p> <p>LP-S044, LP-S070</p>				
OP	DATA type	Available device / Description / Range	Error	Zero	Carry	Borrow	Step
<b>S</b>	WORD	X, Y, M, S, T, C, D, Z, F, UW, integer	☐	☐	☐	☐	5
		Device address which saves the Dec ASCII data to be converted as BCD value					
		h30 to h39 per byte except sign bit (h2D, h28)					
<b>D</b>	WORD	Y, M, S, T, C, D, Z, F, UW	☐	☐	☐	☐	5
		Device address to save converted data					
		h0000 to h9999					

<Ladder>

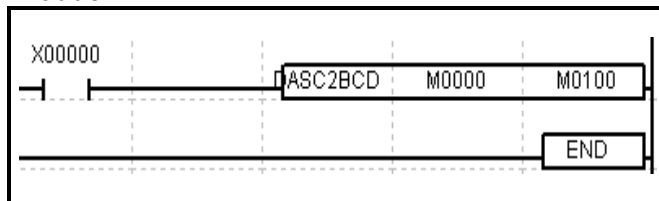

1. Recognizes the ASCII data stored in S word as decimal number and convert it into the BCD code then stores it into the D word.
2. The converted value is stored as Unsigned and the operation range is h0000 to h9999.
3. If the converted result is not in the valid ASCII range(h30 to h39), error flag is SET.

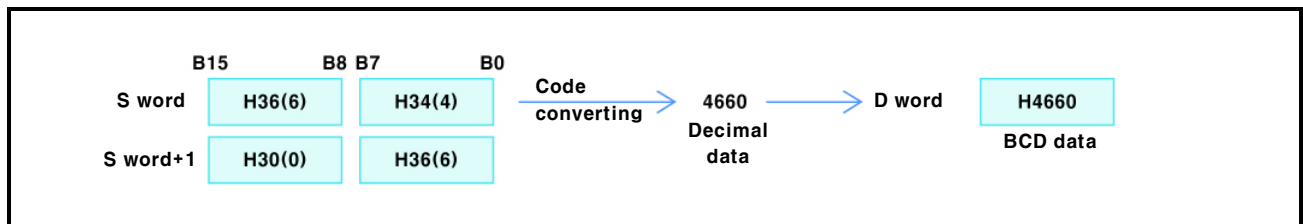

### 3.2.200 String conversion instruction(DDASC2BCD)

<p><b>String conversion instruction</b>    <b>DDASC2BCD</b>    <b>S</b>    <b>D</b></p>			<p>Applicable model LP-S044, LP-S070</p>				
OP	DATA type	Available device / Description / Range	Error	Zero	Carry	Borrow	Step
<b>S</b>	WORD	X, Y, M, S, T, C, D, Z, F, UW, integer	☉				5
		Device address which saves the Dec ASCII data to be converted as BCD value					
		Allowable range per byte (h30 to h39)					
<b>D</b>	DWORD	Y, M, S, T, C, D, Z, F, UW					
		Device address to save converted data					
		h00000000 to h99999999					

<Ladder>

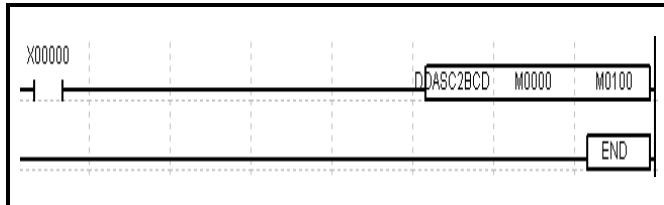

1. Recognizes the ASCII data stored in S word as decimal number and convert it into the BCD code, then stores it into the D word one by one.
2. The converted value is stored as Unsigned, and the operation range is 'h00000000 to h99999999'.
3. If the converted result is not in the valid ASCII range (h30 to h39), error flag is SET. (BCD range: 0 to 9)

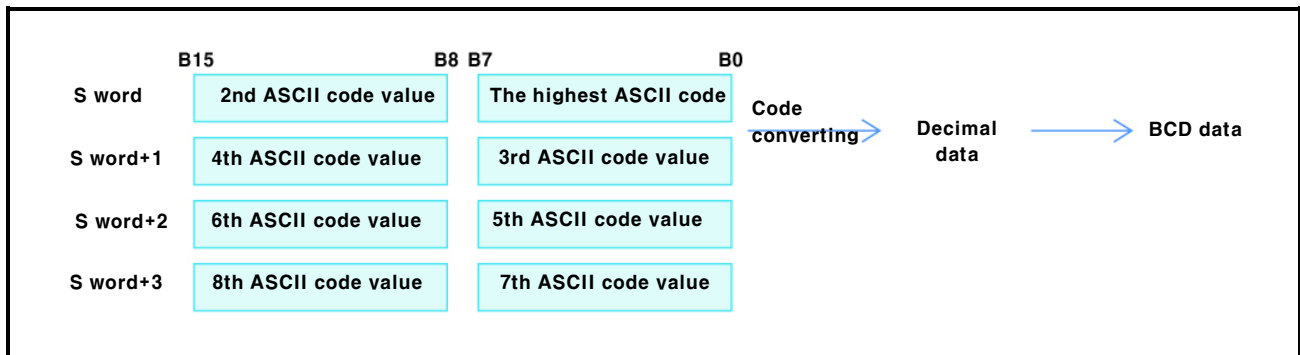

### 3.2.201 String conversion instruction(BIN2DASC)

<b>String conversion instruction</b>			<b>BIN2DASC</b>	<b>S</b>	<b>D</b>	Applicable model LP-S044, LP-S070				
OP	DATA type	Available device / Description / Range				Error	Zero	Carry	Borrow	Step
S	WORD	X, Y, M, S, T, C, D, Z, F, UW, integer								5
		Device address which saves the data to be converted as ASCII value -32768(h8000) to 32767(h7FFF)								
D	WORD	Y, M, S, T, C, D, Z, F, UW								
		Device address to save converted data h30 to h39 per byte except sign bit (h2D, h28)								

<Ladder>

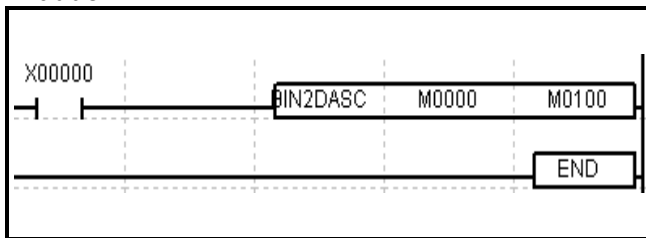

1. Recognizes the BIN data stored in S word as decimal number and converts it into the ASCII code, then stores it sequentially into the D, beginning with D word, by 2 digits per word.
2. If the word value of S is negative, the sign value '– (H2D)' will firstly be output on the first byte of D word.
3. Executes the Signed operation, and the operation range is -32768(h8000) to 32767(h7FFF).

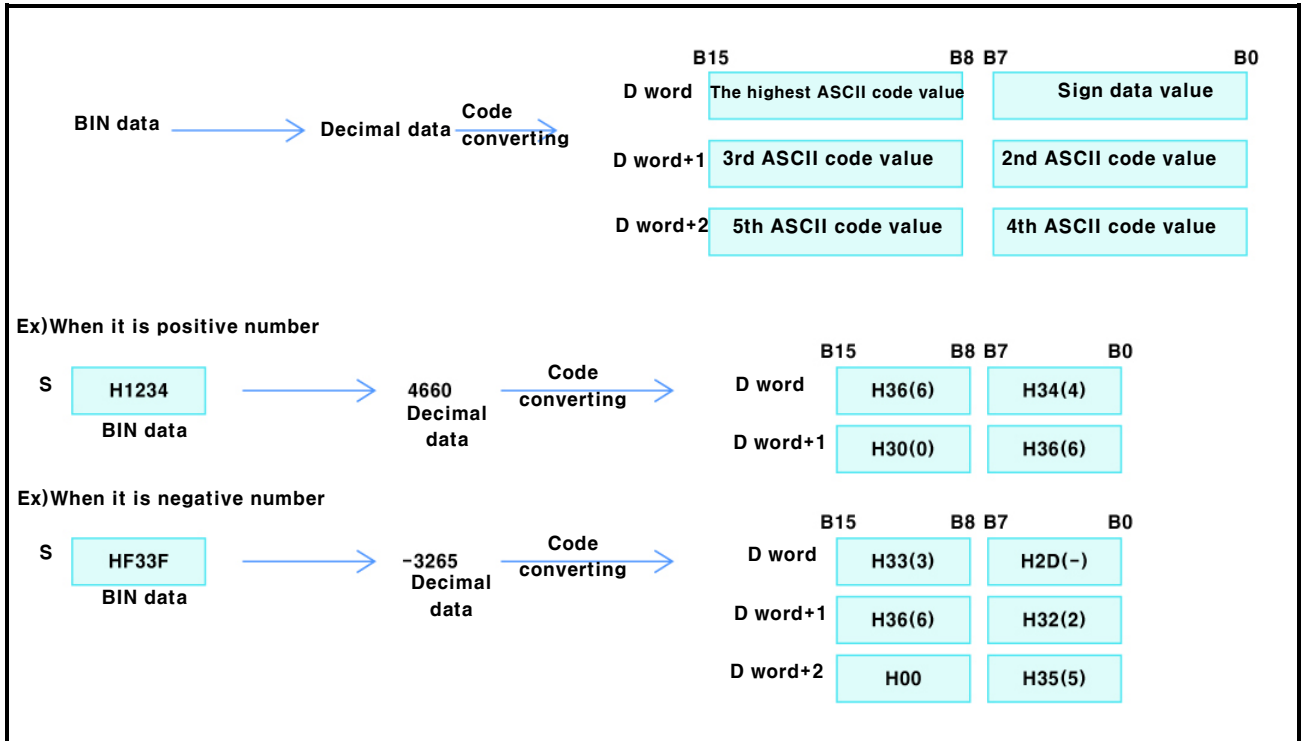

### 3.2.202 String conversion instruction(DBIN2DASC)

<p><b>String conversion instruction</b>    <b>DBIN2DASC</b>    <b>S</b>    <b>D</b></p>			<p>Applicable model LP-S044, LP-S070</p>				
OP	DATA type	Available device / Description / Range	Error	Zero	Carry	Borrow	Step
<b>S</b>	DINT	X, Y, M, S, T, C, D, Z, F, UW, integer	<input type="checkbox"/>	<input type="checkbox"/>	<input type="checkbox"/>	<input type="checkbox"/>	5
		Device address which saves the data to be converted as ASCII value -2147483648(h80000000) to 2147483647(hFFFFFFF)					
<b>D</b>	WORD	Y, M, S, T, C, D, Z, F, UW	<input type="checkbox"/>	<input type="checkbox"/>	<input type="checkbox"/>	<input type="checkbox"/>	5
		Device address to save converted data h30 to h39 per byte except sign bit (h2D, h28)					

<Ladder>

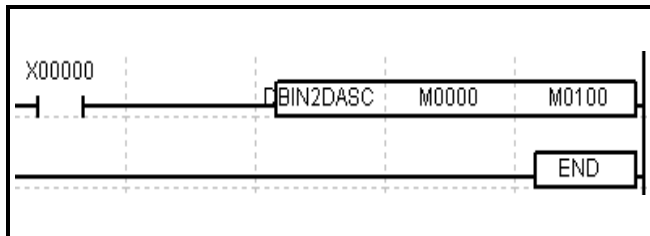

1. Recognizes the BIN data stored in S double word as decimal number and converts it into the ASCII, then stores it into the D word beginning with D, by 2 digits per word.
2. If the word value of S is negative, the sign value ‘- (H2D)’ will firstly be output on the first byte of D word.
3. Executes the Signed operation, and the operation range is -2147483648 (h80000000) to 2147483647(h7FFFFFFF).

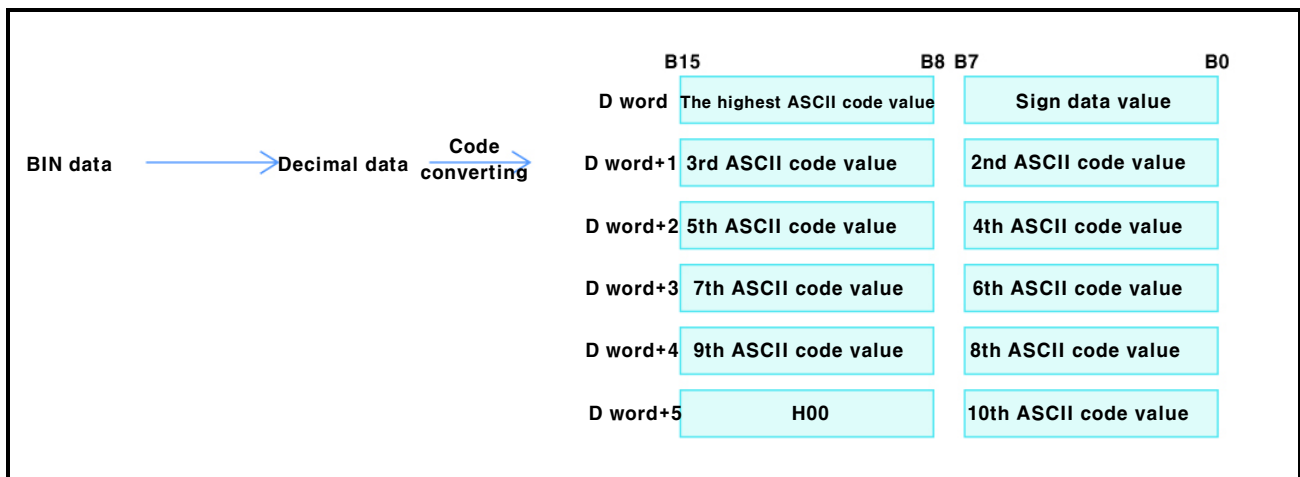



### 3.2.204 Code conversion instruction(DGRY2BIN)

Code conversion instruction			DGRY2BIN	S	D	Applicable model				
						LP-S044, LP-S070				
OP	DATA type	Available device / Description / Range				Error	Zero	Carry	Borrow	Step
S	DWORD	X, Y, M, S, T, C, D, Z, F, UW, integer								5
		Device address which saves the GRAY code data to be converted as BIN value								
		0(h00000000) to 4294967295(hFFFFFFFF)								
D	DWORD	Y, M, S, T, C, D, Z, F, UW								
		Device address to save converted data								
		0(h00000000) to 4294967295(hFFFFFFFF)								

<Ladder>

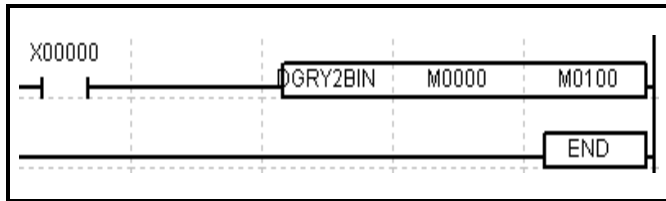

Converts the GRAY code data stored in S double word into the BINARY data and stores it into the D double word.

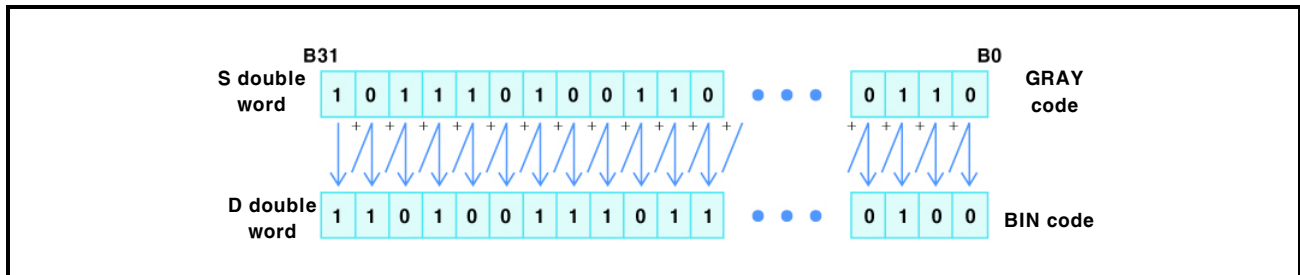

### 3.2.205 Code conversion instruction(BIN2GRY)

Code conversion instruction			BIN2GRY	S	D	Applicable model				
						LP-S044, LP-S070				
OP	DATA type	Available device / Description / Range				Error	Zero	Carry	Borrow	Step
S	WORD	X, Y, M, S, T, C, D, Z, F, UW, integer								5
		Device address which saves the data to be converted as GRAY code value								
		0(h0000) to 65535(hFFFF)								
D	WORD	Y, M, S, T, C, D, Z, F, UW								
		Device address to save converted data								
		0(h0000) to 65535(hFFFF)								

<Ladder>

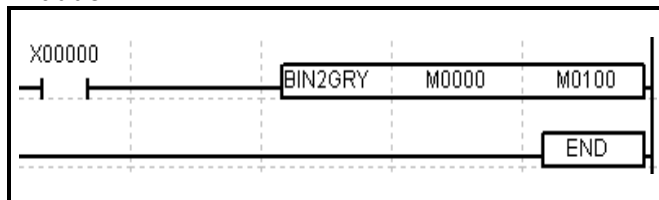

Converts the BINARY code data stored in S word into the GRAY code data and then stores it into the D word.

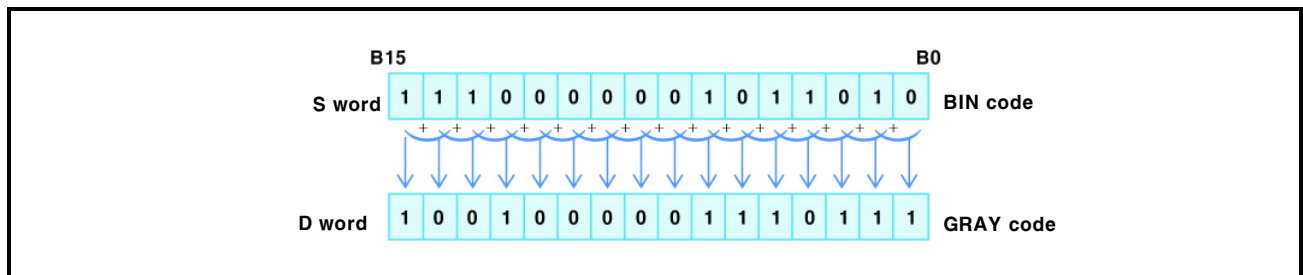

### 3.2.206 Code conversion instruction(DBIN2GRY)

Code conversion instruction			Applicable model				
OP	DATA type	Available device / Description / Range	Error	Zero	Carry	Borrow	Step
S	DWORD	X, Y, M, S, T, C, D, Z, F, UM, integer					5
		Device address which saves the data to be converted as GRAY code value 0(h00000000) to 4294967295(hFFFFFFFF)					
D	DWORD	Y, M, S, T, C, D, Z, F, UW					
		Device address to save converted data 0(h00000000) to 4294967295(hFFFFFFFF)					

<Ladder>

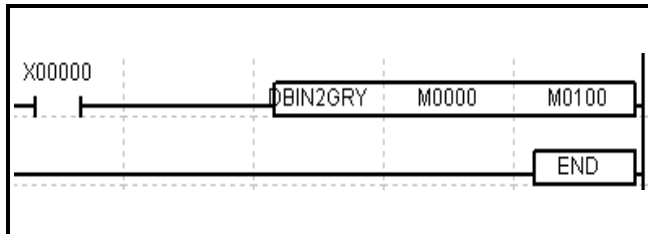

Converts the BINARY code data stored in S double word into the GRAY code data and then stores it into the D double word.

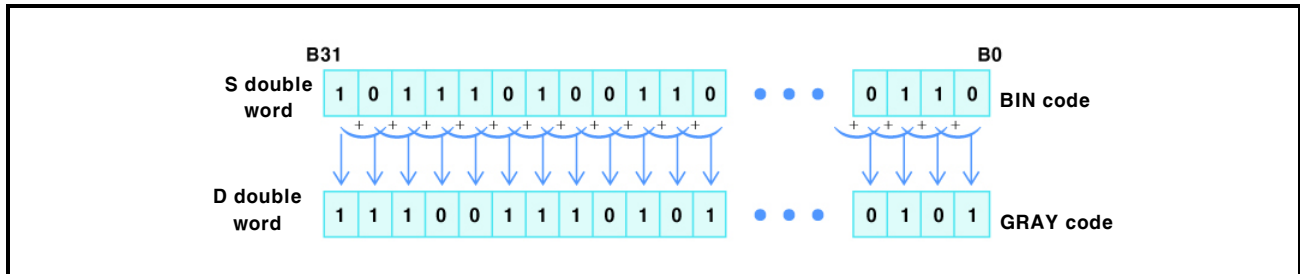



### 3.2.207 Sign reversal instruction(NEG)

<b>Sign reversal instruction</b>		<b>NEG</b>	<b>D</b>	Applicable model LP-S044, LP-S070					
OP	DATA type	Available device / Description / Range			Error	Zero	Carry	Borrow	Step
<b>D</b>	WORD	Y, M, S, T, C, D, Z, F, UW							3
		Device address to convert sign							
		0(h0000) to 65535(hFFFF)							

<Ladder>

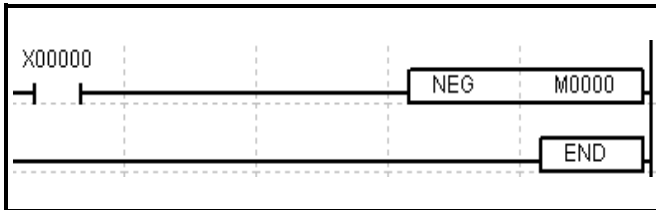

Reverses the sign of D word.

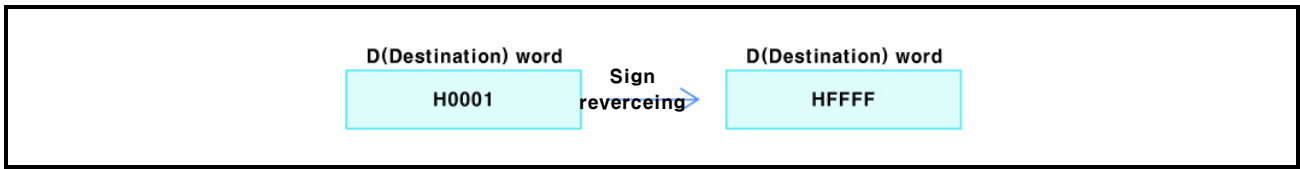

### 3.2.208 Sign reversal instruction(DNEG)

<b>Sign reversal instruction</b>		<b>DNEG</b>	<b>D</b>	Applicable model LP-S044, LP-S070					
OP	DATA type	Available device / Description / Range			Error	Zero	Carry	Borrow	Step
<b>D</b>	DWORD	Y, M, S, T, C, D, Z, F, UW							3
		Device address to convert sign							
		0(h00000000) to 4294967295(hFFFFFFF)							

<Ladder>

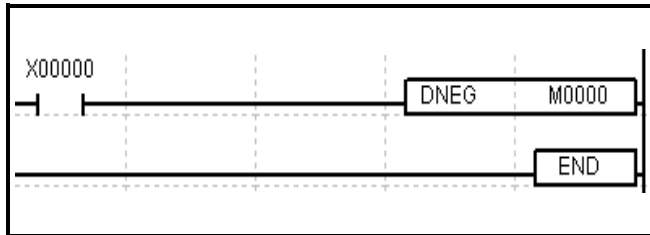

Reverses the sign of D double word.

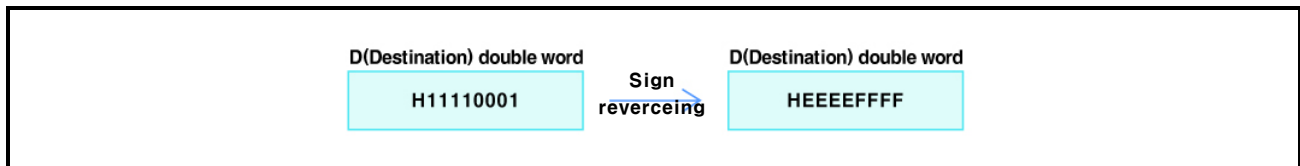

### 3.2.209 Data conversion instruction(DECO)

Data conversion Instruction			Applicable model				
OP	DATA type	Available device / Description / Range	Error	Zero	Carry	Borrow	Step
S	WORD	X, Y, M, S, T, C, D, Z, F, UW	☉				7
		Data address to execute the decoder operation					
		0(h0000) to 65535(hFFFF)					
D	WORD	Y, M, S, T, C, D, Z, F, UW					
		Address to save the operation result					
		0(h0000) to 65535(hFFFF)					
N	WORD	X, Y, M, S, T, C, D, Z, F, UW, integer					
		The number of bits to be decoded					
		0 to 8					

<Ladder>

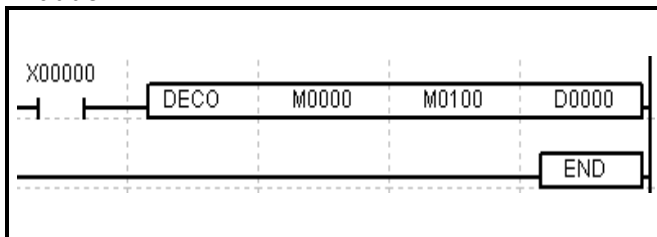

1. Decodes the number of B bits stored in S word from 0 to N and stores the result into the D word.
2. If the N is 0, it does not execute the instruction.
3. If the decoded value is not in the range from 0 to 8, error flag is SET.

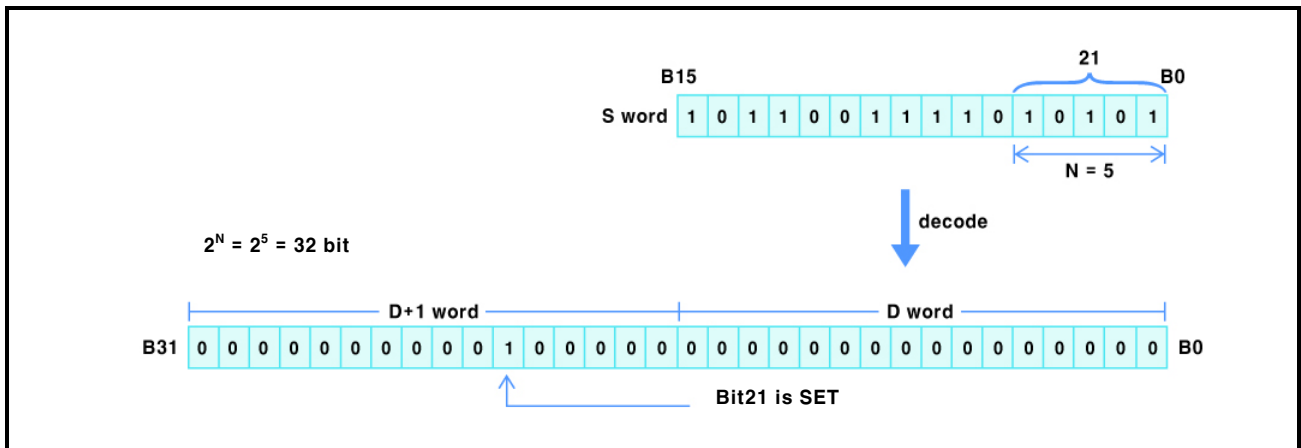

### 3.2.210 Data conversion instruction(ENCO)

Data conversion instruction			Applicable model				
OP	DATA type	Available device / Description / Range	Error	Zero	Carry	Borrow	Step
S	WORD	X, Y, M, S, T, C, D, Z, F, UW	☉	☉			7
		Data address to execute the encoder operation 0(h0000) to 65535(hFFFF)					
D	WORD	Y, M, S, T, C, D, Z, F, UW					
		Address to save the operation result 0(h0000) to 65535(hFFFF)					
N	WORD	X, Y, M, S, T, C, D, Z, F, UW, integer					
		The number of words to be encoded 0 to 8					

<Ladder>

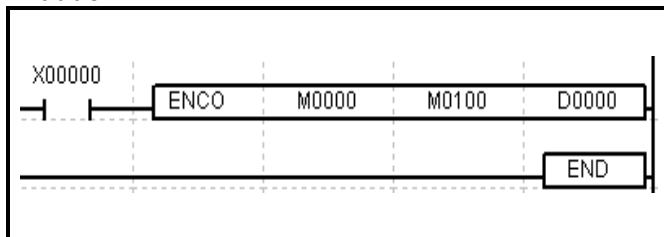

1. Encodes the number of N words from S to N and stores them into the D.
2. If the N is not in the range from 0 to 8, error flag is SET.
3. If the encoded value is 0, zero flag is SET.
4. If N is 0, it does not execute the instruction.

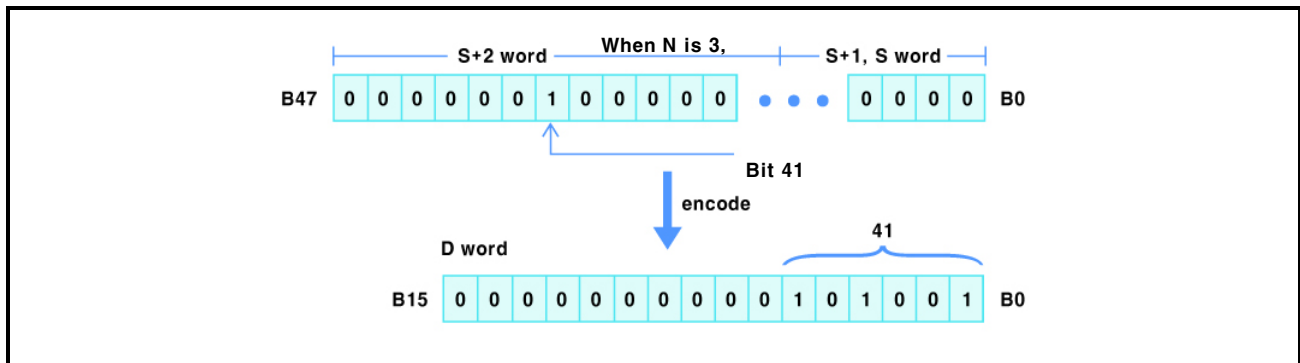

### 3.2.211 Data conversion instruction(EXT)

Data conversion instruction			EXT	D	Applicable model LP-S044, LP-S070				
OP	DATA type	Available device / Description / Range			Error	Zero	Carry	Borrow	Step
D	INT	Y, M, S, D, UW Data address to execute the operation -32768(h8000) to 32767(h7FFF)							3

<Ladder>

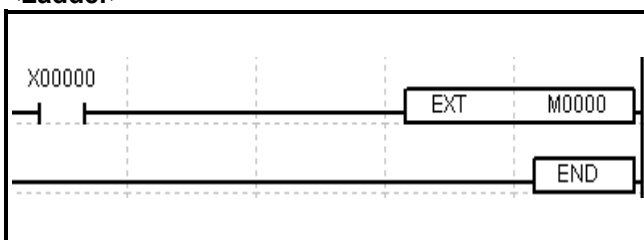

1. Extends the value of D word to 32bit.
2. Executes the Signed operation.

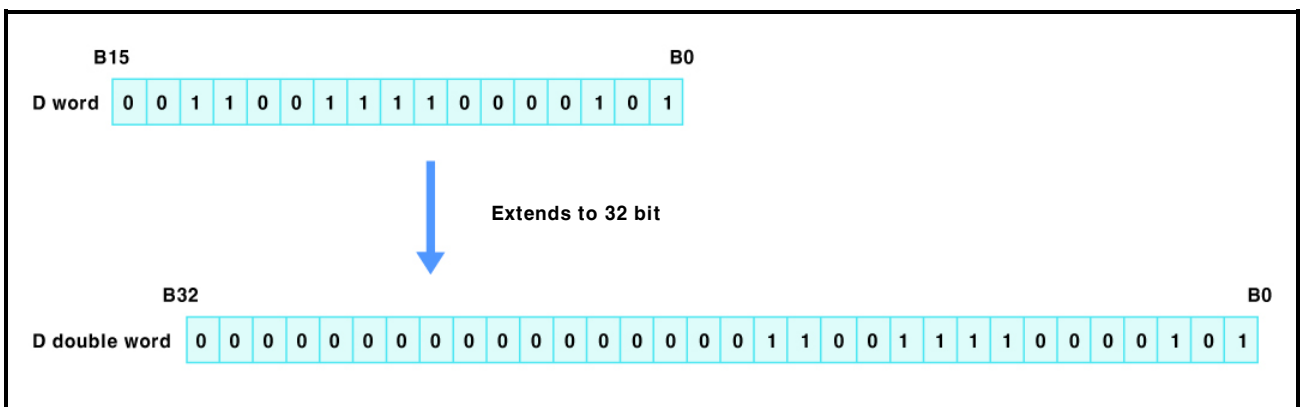

### 3.2.212 Refresh instruction(REF)

Refresh instruction			REF	D	N	Applicable model LP-S044, LP-S070				
OP	DATA type	Available device / Description / Range				Error	Zero	Carry	Borrow	Step
D	BIT	X, Y								5
		Input/Output bit device								
		Not applicable								
N	WORD	X, Y, M, S, T, C, D, Z, F, UW, integer								
		The number of bit devices to refresh from D bit								
		0 to 65535								

<Ladder>

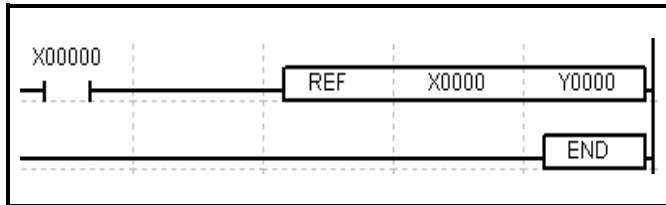

Refreshes the number of N bit devices beginning with I/O D bit device.

### 3.2.213 Display instruction(SEG)

Display instruction		SEG	S	D	N	Applicable model LP-S044, LP-S070				
OP	DATA type	Available device / Description / Range				Error	Zero	Carry	Borrow	Step
S	BIT	X, Y, M, UB								7
		Address which saves the data to be decoded as 7 segment								
		Not applicable								
D	BIT	Y, M, UB								
		Address to save the decoded data								
		Not applicable								
N	WORD	X, Y, M, S, T, C, D, Z, F, UW, integer\								
		The number of data to be decoded								

<Ladder>

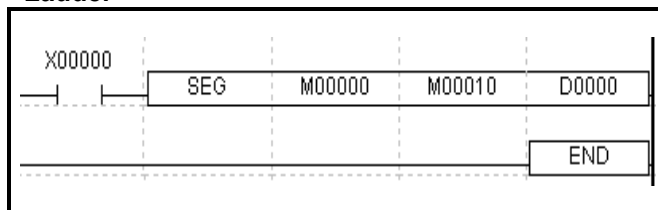

Decodes the number of N data composed of 4 bit per each to the 7 segment data, one by one, and stores it as the number of N data composed of 8 bit per each.

[Segment structure]

4 input bit		Segment structure	DECODE							Segment display	
Hex.	Bit		h	g	f	e	d	c	b		a
0	0000		0	0	1	1	1	1	1	1	0
1	0001		0	0	0	0	0	1	1	0	1
2	0010		0	1	0	1	1	0	1	1	2
3	0011		0	1	0	0	1	1	1	1	3
4	0100		0	1	1	0	0	1	1	0	4
5	0101		0	1	1	0	1	1	0	1	5
6	0110		0	1	1	1	1	1	0	1	6
7	0111		0	0	1	0	0	1	1	1	7
8	1000		0	1	1	1	1	1	1	1	8
9	1001		0	1	1	0	0	1	1	1	9
A	1010		0	1	1	1	0	1	1	1	A
B	1011		0	1	1	1	1	1	0	0	B
C	1100		0	0	1	1	1	0	0	1	C
D	1101		0	1	0	1	1	1	1	0	D
E	1110		0	1	1	1	1	0	0	1	E
F	1111		0	1	1	1	0	0	0	1	F

Ex) When N is 3

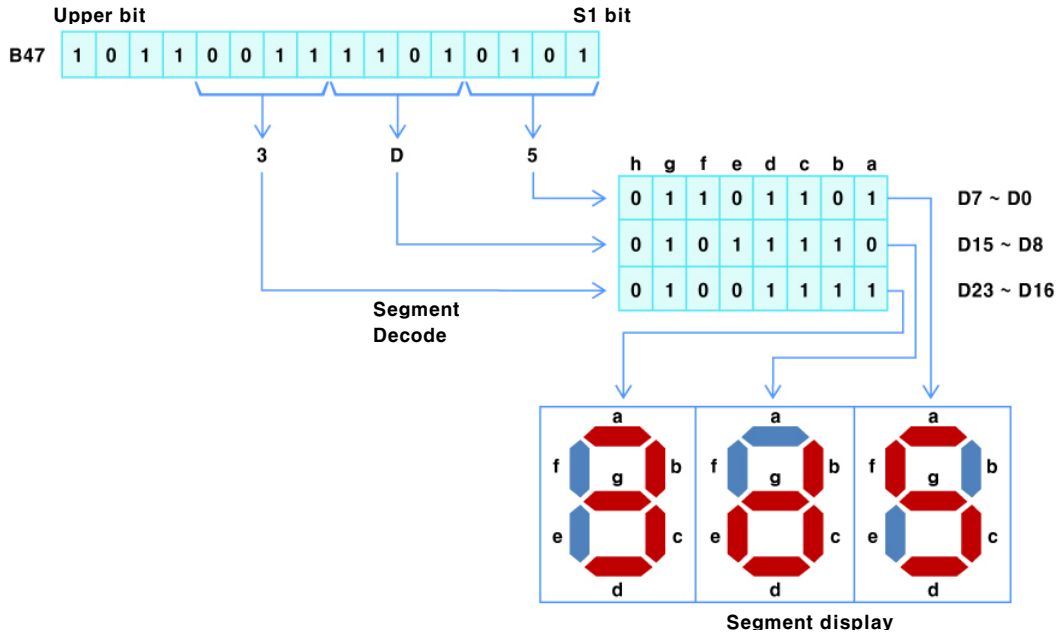

[The structure when connecting AUTONICS display unit]

Display		Negative logic input						Postive logic input					
Hex.	Dec.	S+3BIT	S+2BIT	S+1BIT	S BIT	BI	LATCH	S+3BIT	S+2BIT	S+1BIT	S BIT	BI	LATCH
Zero Blank	Zero Blank	1	1	1	1	1	1	0	0	0	0	1	0
0	0	1	1	1	1	0	1	0	0	0	0	0	0
1	1	1	1	1	0	x	1	0	0	0	1	x	0
2	2	1	1	0	1	x	1	0	0	1	0	x	0
3	3	1	1	0	0	x	1	0	0	1	1	x	0
4	4	1	0	1	1	x	1	0	1	0	0	x	0
5	5	1	0	1	0	x	1	0	1	0	1	x	0
6	6	1	0	0	1	x	1	0	1	1	0	x	0
7	7	1	0	0	0	x	1	0	1	1	1	x	0
8	8	0	1	1	1	x	1	1	0	0	0	x	0
9	9	0	1	1	0	x	1	1	0	0	1	x	0
A	Blank	0	1	0	1	x	1	1	0	1	0	x	0
B	Blank	0	1	0	0	x	1	1	0	1	1	x	0
C	Blank	0	0	1	1	x	1	1	1	0	0	x	0
D	Blank	0	0	1	0	x	1	1	1	0	1	x	0
E	Blank	0	0	0	1	x	1	1	1	1	0	x	0
F	Blank	0	0	0	0	x	1	1	1	1	1	x	0
HOLD		x	x	x	x	x	0	x	x	x	x	x	H

"X" : It does not matter whether you input HIGH or LOW level signal.

Blank: It does not display anything even if you input the signal by using input data.

If you connect BI terminal to the VCC(HIGH level)D, it executes the Zero blanking, and if you connect BI terminal to the GND(LOW level) terminal, it displays 0.

\*AUTONICS display unit has embedded DECODER DRIVER, therefore you can use S bit without D(Destination) bit.



### 3.2.214 Clock instruction(TCMP)

Clock instruction	TCMP	S1	S2	S3	S4	D	Applicable model				
							LP-S044, LP-S070				
OP	DATA type	Available device / Description / Range					Error	Zero	Carry	Borrow	Step
S1	WORD	X, Y, M, S, T, C, D, Z, F, UW, integer					☐	☐	☐	☐	7
		Device address which saves the data to be compared with 'hour' data of S4									
		0(h0000) to 23(h0017)									
S2	WORD	X, Y, M, S, T, C, D, Z, F, UW, integer					☐	☐	☐	☐	
		Device address which saves the data to be compared with 'minute' data of S4									
		0(h0000) to 59(h0038)									
S3	WORD	X, Y, M, S, T, C, D, Z, F, UW, integer					☐	☐	☐	☐	
		Device address which saves the data to be compared with 'second' data of S4									
		0(h0000) to 59(h0038)									
S4	WORD	X, Y, M, S, T, C, D, Z, F, UW					☐	☐	☐	☐	
		Device address which saves the data to be compared with the data of S1, S2 and S3.									
		Time data range									
D	BIT	Y, M, S, T, C, Z, F, UB					☐	☐	☐	☐	
		Bit device address to save the comparison result									
		Not applicable									

<Ladder>

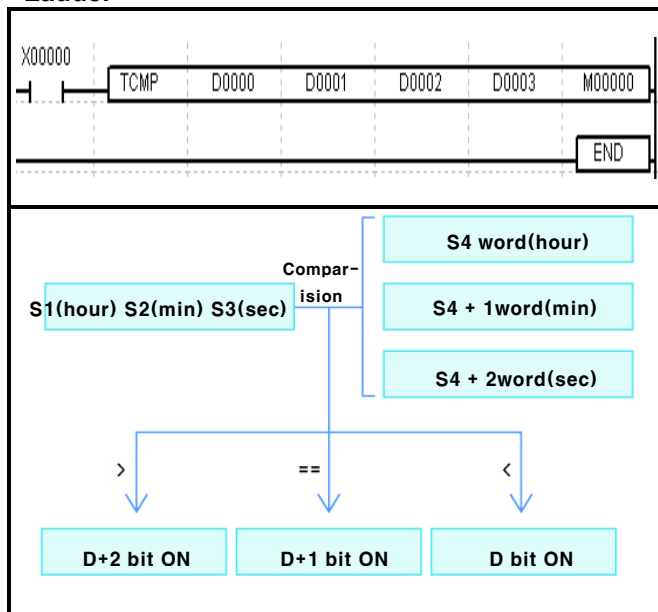

Compares a data composed of S1(hour), S2(minute), and S3(second) with a data composed of S4 to S4+2 word, and as a result;

1. If the two values are equal, D bit turns ON.
2. If S4 is less than the former, D+1 bit turns ON.
3. If S4 is larger than the former, D+2 bit turns ON.
4. If S4 value is read as TRD instruction and available.
5. If the input value is not time data (hour:0 to 23, minute:0 to 59, second:0 to 59) error flag is SET.

### 3.2.215 Clock instruction(TADD)

Clock instruction			TADD	S1	S2	D	Applicable model LP-S044, LP-S070				
OP	DATA type	Available device / Description / Range					Error	Zero	Carry	Borrow	Step
S1	WORD	X, Y, M, S, T, C, D, Z, F, UW					☉		☉		7
		Device address which saves the data to execute the time addition operation with S2									
		Time data range									
S2	WORD	X, Y, M, S, T, C, D, Z, F, UW									
		Device address which saves the data to execute the time addition operation with S1									
		Time data range									
D	WORD	Y, M, S, T, C, D, Z, F, UW									
		Address to save the operation result									
		Time data range									

<Ladder>

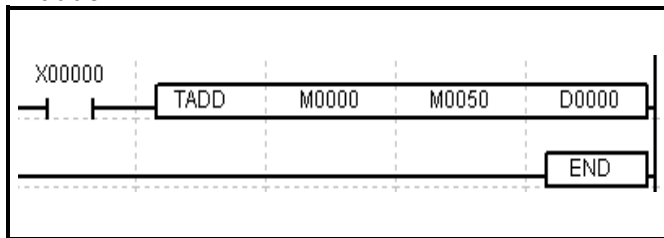

1. Executes the addition operation for each word of S1 device, in which S1(hour), S1+1(minute), or S1+2(second), is stored, and the corresponding word of S2 device, in which S2(hour), S2+1(minute), or S2+2(second) is stored, and store the result into the designated word of D device respectively.
  2. If the time exceeds 24 o'clock, carry flag occurs and the data is stored from 0 again.
  3. If the input value is not time data (hour:0 to 23, minute:0 to 59, second:0 to 59) error flag is SET.
- (Note) Recognizes and displays the data as binary value.

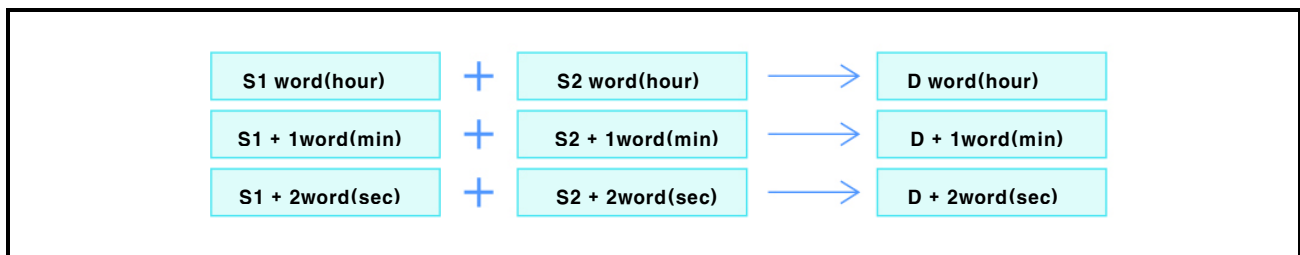

### 3.2.216 Clock instruction(TSUB)

Clock instruction			TSUB	S1	S2	D	Applicable model LP-S044, LP-S070				
OP	DATA type	Available device / Description / Range					Error	Zero	Carry	Borrow	Step
S1	WORD	X, Y, M, S, T, C, D, Z, F, UW					☐	☐	☐	☐	7
		Device address which saves the data to execute the time subtraction operation with S2									
		Time data range									
S2	WORD	X, Y, M, S, T, C, D, Z, F, UW					☐	☐	☐	☐	7
		Device address which saves the data to execute the time subtraction operation with S1									
		Time data range									
D	WORD	Y, M, S, T, C, D, Z, F, UW					☐	☐	☐	☐	7
		Address to save the operation result									
		Time data range									

<Ladder>

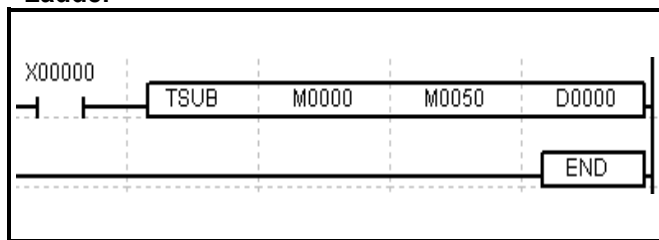

1. Executes the subtraction operation for each word of S1 device, in which S1(hour)/S1+1(minute)/S1+2(second) is stored, and the corresponding word of S2 in which S2(hour), S2+1(minute) or S2+2(second) is stored, and then stores the result into the designated word of D device.
2. If the time is less than 0 o'clock, borrow flag occurs and stores the result after converting into 24-hour data.
3. If the input value is not time data (hour:0 to 23, minute:0 to 59, second:0 to 59) error flag is SET.  
(Note) Recognizes and displays the data as binary value.

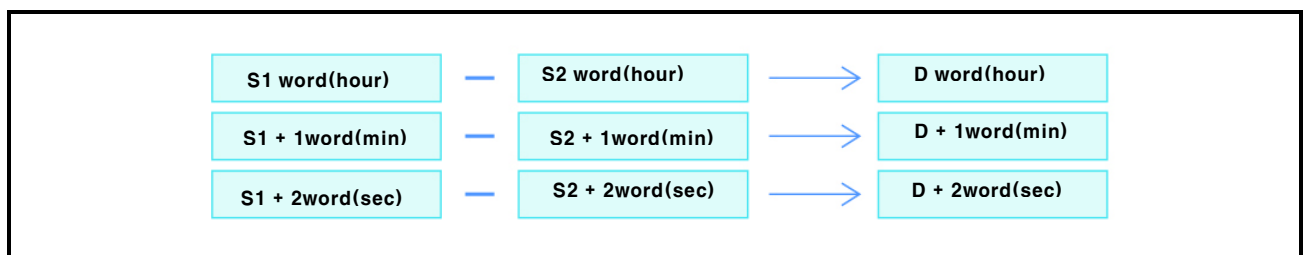

### 3.2.217 Clock instruction(TRD)

Clock instruction		TRD	D	Applicable model					
				LP-S044, LP-S070					
OP	DATA type	Available device / Description / Range			Error	Zero	Carry	Borrow	Step
D	WORD	Y, M, S, T, C, D, Z, F, UW							3
		Device address to save the real time value							
		Not applicable							

<Ladder>

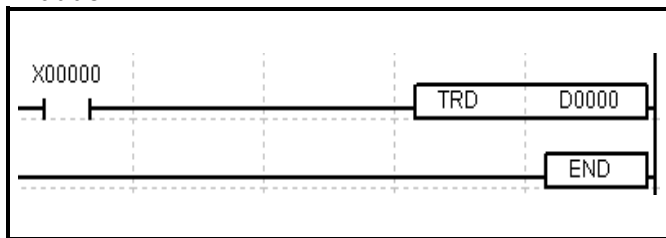

The real time value is stored as below.

1. Year in D word
2. Month in D+1 word
3. Date in D+2 word
4. Hour in D+3 word
5. Minute in D+4 word
6. Second in D+5 word
7. Day of week in D+6 word

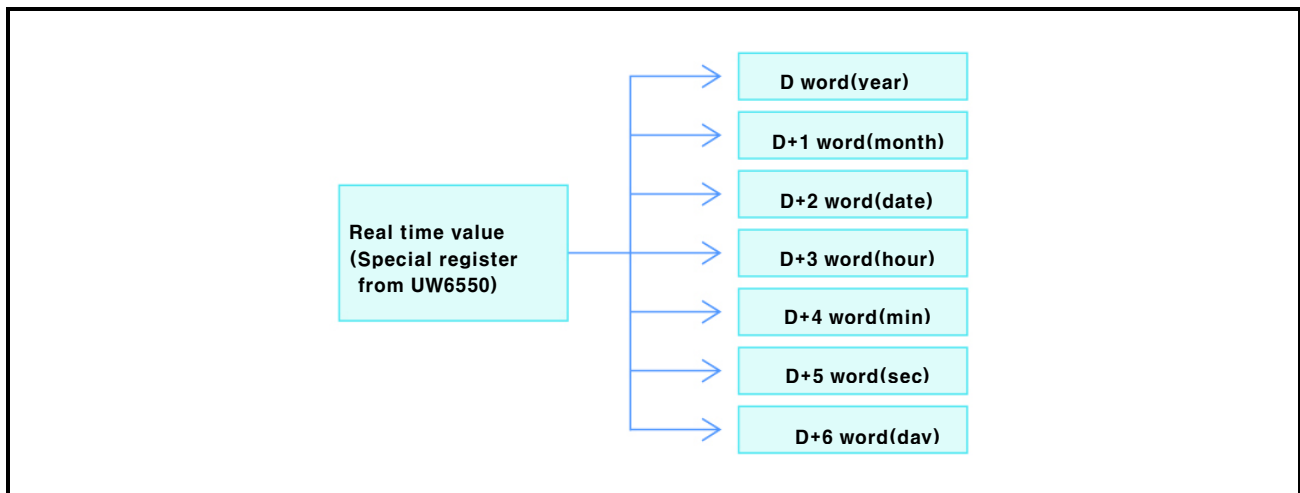

**3.2.218 Clock instruction(TWR)**

Clock instruction		TWR	D	Applicable model LP-S044, LP-S070					
OP	DATA type	Available device / Description / Range			Error	Zero	Carry	Borrow	Step
D	WORD	Y, M, S, T, C, D, Z, F, UW							
		Device address which saves the time data to write on special register							
		Time data range							3

<Ladder>

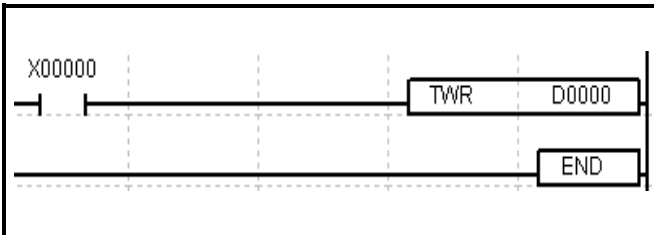

1. Year in D word
2. Month in D+1 word (1 to 12)
3. Date in D+2 word (1 to 31)
4. Hour in D+3 word (1 to 23)
5. Minute in D+4 word (1 to 59)
6. Second in D+5 word (1 to 59)
7. Day of week in D+6 word (0-sunday to 6-saturday) are stored respectively.
8. Stores the time value into the corresponding position of special register.
9. The special register (time setting) is also been running along with executing TWR instruction.
10. If the input data is out of the valid time range, error flag occurs.

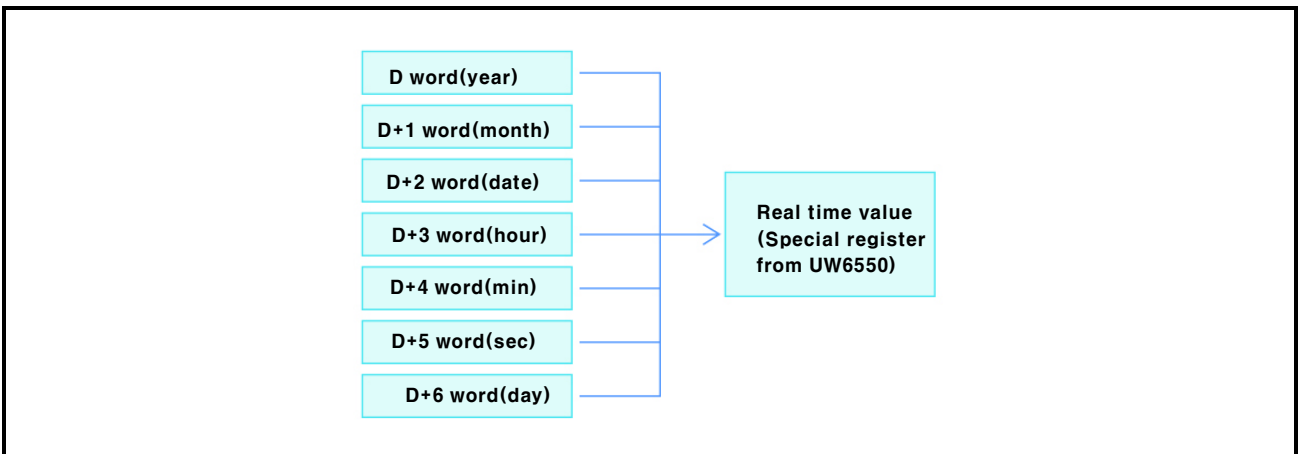

### 3.2.219 Clock instruction(HOUR)

Clock instruction			HOUR	S	D1	D2	Applicable model LP-S044, LP-S070				
OP	DATA type	Available device / Description / Range					Error	Zero	Carry	Borrow	Step
S	WORD	X, Y, M, S, T, C, D, Z, F, UW, integer									7
		Data device address to designate the accumulated time									
		0(h0000) to 65535(hFFFF)									
D1	WORD	Y, M, S, T, C, D, Z, F, UW									
		Data device address which saves the executed time value									
		0(h0000) to 65535(hFFFF)									
D2	BIT	Y, M, UB									
		The compared result between the executed time (D1) and the designated accumulated time(S)									
		Not applicable									

<Ladder>

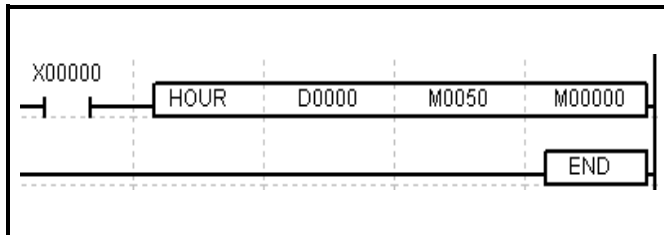

1. If the input contact retains ON status for the designated time (time unit) in S word device, D2 bit turns ON.
2. The ON time value in D1 word device
3. The current value of less then 1 hour is displayed in D1+1 word device at per one second.

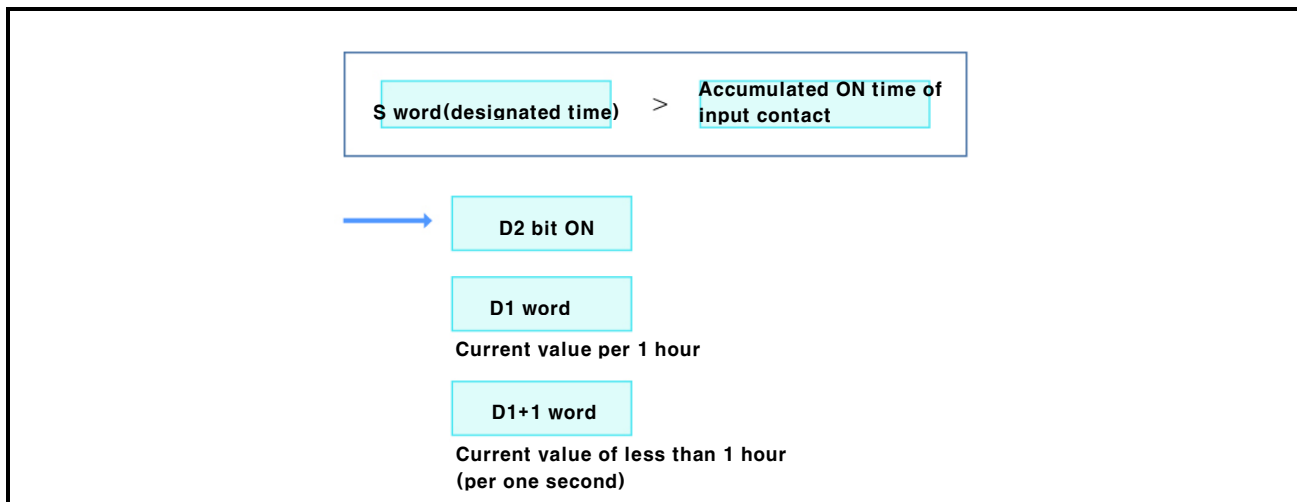

**3.2.220 Clock instruction(TZCP)**

Clock instruction		TZCP	S1	S2	S3	D	Applicable model LP-S044, LP-S070				
OP	DATA type	Available device / Description / Range					Error	Zero	Carry	Borrow	Step
S1	WORD	X, Y, M, S, T, C, D, Z, F, UW					☉				9
		Device address which saves the data to compare with S2 and S3 data									
		Time data range									
S2	WORD	X, Y, M, S, T, C, D, Z, F, UW									
		Device address which saves the data to compare with S1 and S3 data									
		Time data range									
S3	WORD	X, Y, M, S, T, C, D, Z, F, UW									
		Device address which saves the data to compare with S1 and S2 data									
		Time data range									
D	BIT	Y, M, S, T, C, Z, F, UB									
		Bit device address to save comparison result									
		Not applicable									

<Ladder>

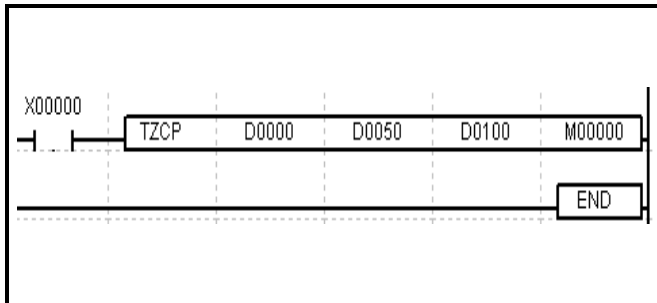

Hour in S1 word, minute in S1+1 word, second in S1+2 word,  
 hour in S2 word, minute in S2+1 word, second in S2+2 word,  
 hour in S3 word, minute in S3+1 word, second in S3+2 word,  
 are stored respectively and compares the S3 device value between S1 device and S2 device. As a result:

1. If S3 value is less than S1 and S2 value, D bit turns ON.
2. If S3 value is equal to the smaller value of S1 or S2, D+1 bit turns ON.
3. If S3 value is between the values of S1 value and S2 value, D+2 bit turns ON.
4. If S3 value is equal to the bigger value of S1 or S2, D+3 bit turns ON.
5. If S3 value is larger than S1 value and S2 value, D+4 bit turns ON.
6. If the source data is out of the time range (hour: 0 to 23, min: 0 to 59, sec: 0 to 59), error flag occurs.

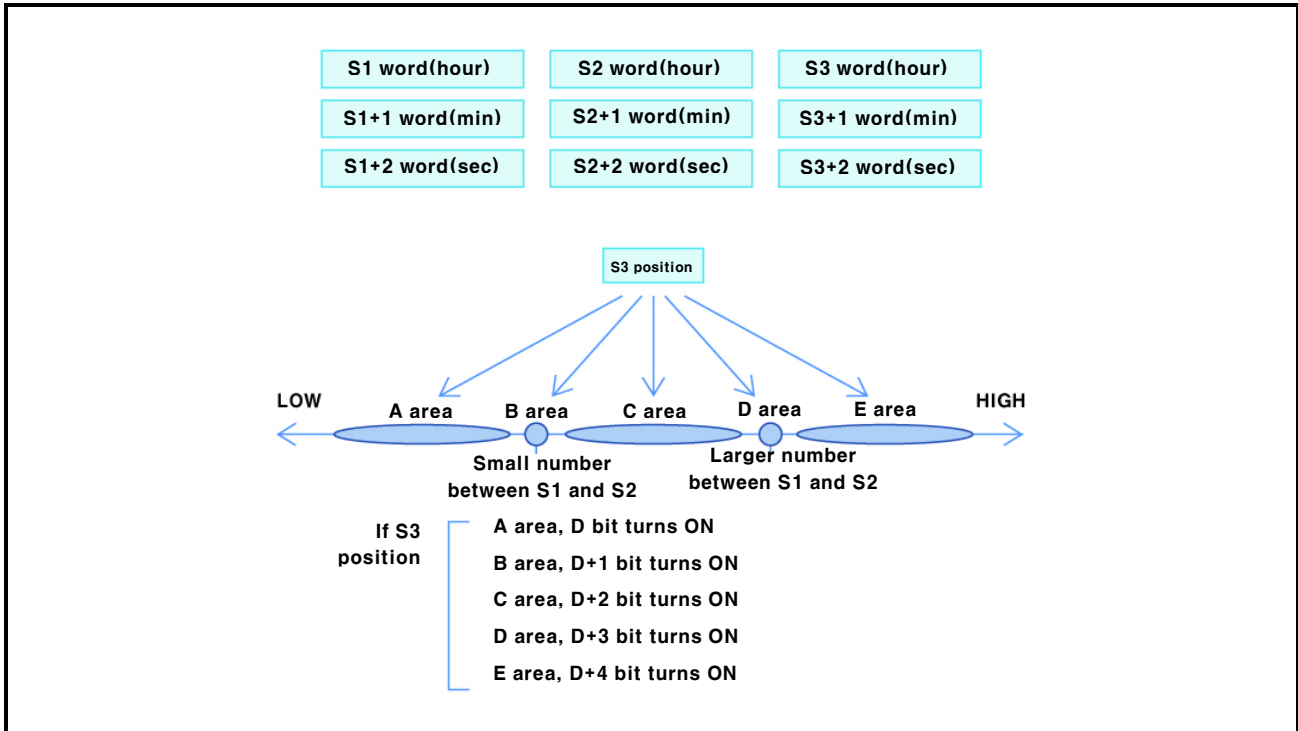



3.2.221 Motion instruction(MTVDM)

Motion instruction	MTVDM	S	S1	S2	S3	S4	S5	Applicable model				
								LP-S070				
OP	DATA type	Available device / Description / Range						Error	Zero	Carry	Borrow	Step
S	WORD	X, M, D, Z, UW, integer						Error	Zero	Carry	Borrow	Step
		Channel(Ch1, Ch2)										
		1 to 2										
S1	BIT	X, M, Z, UB						Error	Zero	Carry	Borrow	Step
		Motion drive direction										
		1: Forward, 0: Backword										
S2	DWORD	X, M, D, Z, UW, integer						Error	Zero	Carry	Borrow	Step
		Drive speed										
		0 to 100,000										
S3	WORD	X, M, D, Z, UW, integer						Error	Zero	Carry	Borrow	Step
		Dwell time										
		0 to 65536ms										
S4	WORD	X, M, D, Z, UW, integer						Error	Zero	Carry	Borrow	Step
		Acceleration time										
		Select acceleration time 1 to 5 in common configuration										
S5	WORD	X, M, D, Z, UW, integer						Error	Zero	Carry	Borrow	Step
		Deceleration time										
		Select deceleration time 1 to 5 in common configuration										

<Ladder>

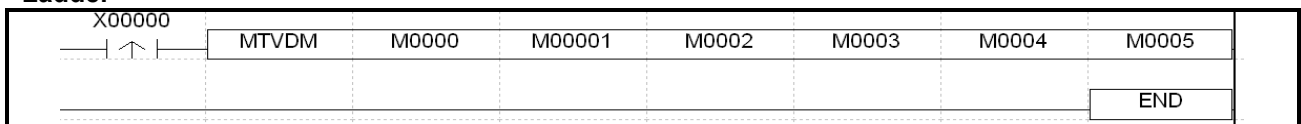

Speed direct drive instruction: You can designate direct drive data(drive speed, drive direction, etc) directly and it executes speed drive.

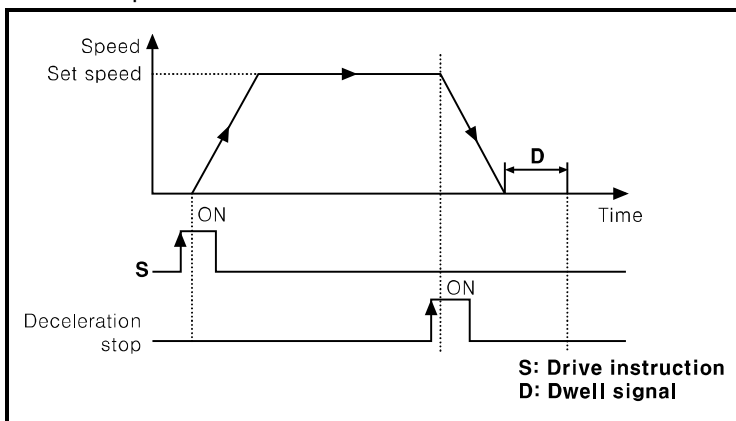

[Note]

1. For utilize direct instruction, set 'TRUE' at 'Enable Ch' of common configuration from [Parameter]-[MOTION]tab in SmartStudio.
2. Select accel/deceleration time 1 to 5 in common configuration from [Parameter]-[MOTION]tab in SmartStudio.
3. You should check whether the correspond channel is using or not before using direct drive instruction.
4. If using channel is input the other instruction, using channel error occurs.

※ For more information, refer to Motion of SmartStudio user manual.

### 3.2.222 Motion instruction(MTPDM)

Motion instruction	MTPDM	S	S1	S2	S3	S4	S5	Applicable model				
								LP-S070				
OP	DATA type	Available device / Description / Range						Error	Zero	Carry	Borrow	Step
S	WORD	X, M, D, Z, UW, integer						<input type="checkbox"/>	<input type="checkbox"/>	<input type="checkbox"/>	<input type="checkbox"/>	<input type="checkbox"/>
		Channel (Ch1, Ch2)										
		1 to 256										
S1	DWORD	X, M, D, Z, UW, integer						<input type="checkbox"/>	<input type="checkbox"/>	<input type="checkbox"/>	<input type="checkbox"/>	<input type="checkbox"/>
		Target position -2,147,483,648 to 2,147,483,647 (Enable to set the range)										
S2	DWORD	X, M, D, Z, UW, integer						<input type="checkbox"/>	<input type="checkbox"/>	<input type="checkbox"/>	<input type="checkbox"/>	<input type="checkbox"/>
		Drive speed 0 to 100,000										
S3	WORD	X, M, D, Z, UW, integer						<input type="checkbox"/>	<input type="checkbox"/>	<input type="checkbox"/>	<input type="checkbox"/>	<input type="checkbox"/>
		Dwell time 0 to 65536ms										
S4	WORD	X, M, D, Z, UW, integer						<input type="checkbox"/>	<input type="checkbox"/>	<input type="checkbox"/>	<input type="checkbox"/>	<input type="checkbox"/>
		Acceleration time Select acceleration time 1 to 5 in common configuration										
S5	WORD	X, M, D, Z, UW, integer						<input type="checkbox"/>	<input type="checkbox"/>	<input type="checkbox"/>	<input type="checkbox"/>	<input type="checkbox"/>
		Deceleration time Select deceleration time 1 to 5 in common configuration										

<Ladder>

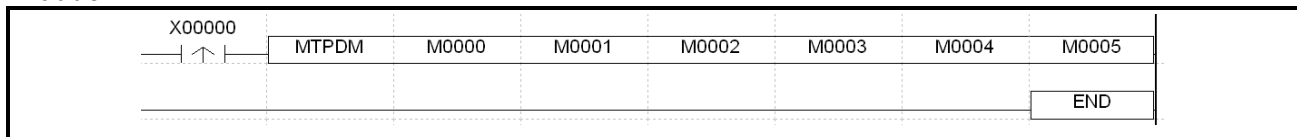

Position direct drive instruction: You can designate direct drive data(drive speed, drive direction, etc) directly and it executes position drive.

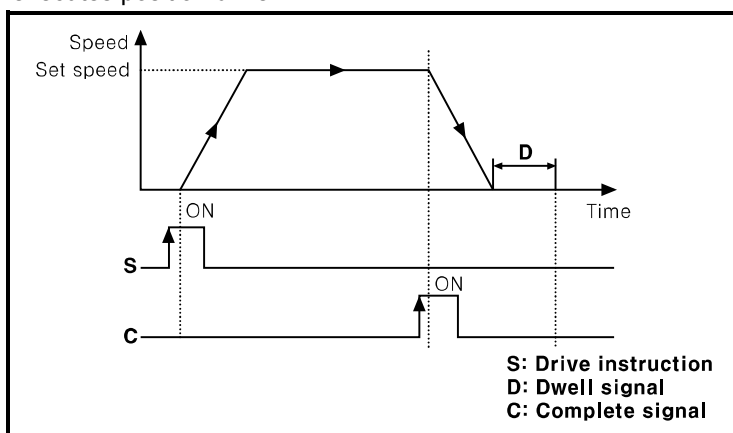

[Note]

1. For utilize direct instruction, set 'TRUE' at 'Enable Ch' of common configuration from [Parameter]-[MOTION]tab in SmartStudio.
2. Select accel/deceleration time 1 to 5 in common configuration from [Parameter]-[MOTION]tab in SmartStudio.
3. You should check whether the correspond channel is using or not before using direct drive instruction.
4. If using channel is input the other instruction, using channel error occurs.

※ For more information, refer to Motion of SmartStudio user manual.

### 3.2.223 Motion instruction(MTIDM)

Motion instruction		MTIDM	S	S1	Applicable model				
					LP-S070				
OP	DATA type	Available device / Description / Range			Error	Zero	Carry	Borrow	Step
S	WORD	X, M, D, Z, UW, integer			☉				5
		Channel(Ch1, Ch2)							
		1 to 2							
S1	WORD	X, M, D, Z, UW, integer							
		Step number							
		1 to 99							

**<Ladder>**

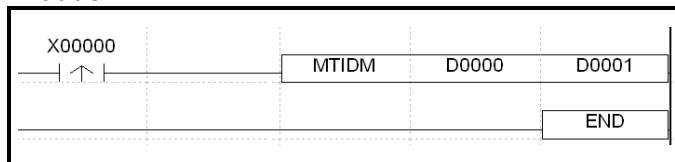

Indirect designate drive instruction: It operates with the number of scripted string in the specified pattern from pattern list.

**[Note]**

1. For utilize indirect drive instruction, set 'TRUE' at 'Enable Ch' of common configuration from [Parameter]-[MOTION]tab in SmartStudio.
2. There should be pattern number to execute of pattern list from from [Parameter]-[MOTION]tab in SmartStudio.
3. You should check whether the correspond channel is using or not before using drive instruction.

**[Pattern stop method]**

1) F400 or F402 (Action list stop) + MTSRS

: During pattern drive, if currently executed action list type is speed drive and this instruction is executed, speed drive is finish and it executes the next action list.

2) F401 or F403 (Group stop) + MTSRS

: During group drive, this instruction is executed, it escapes the group and executes the other action list following the group.

3) Not to set special flag

: Pattern drive is finish.

※ For more information, refer to Motion of SmartStudio user manual.

### 3.2.224 Motion instruction(MTMEC)

Motion instruction		MTMEC	S	Applicable model					
				LP-S070					
OP	DATA type	Available device / Description / Range			Error	Zero	Carry	Borrow	Step
S	WORD	X, M, D, Z, UW, integer			☉				5
		Channel(Ch1, Ch2)							
		1 to 2							

<Ladder>

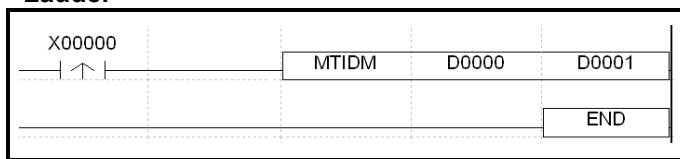

Error remove instruction: This instruction removes the error when error flag occurs by error during motion drive.

※ For more information, refer to Motion of SmartStudio user manual.

**3.2.225 Motion instruction(MTEMS)**

<b>Motion instruction</b>		<b>MTEMS</b>	<b>S</b>	Applicable model LP-S070					
OP	DATA type	Available device / Description / Range			Error	Zero	Carry	Borrow	Step
<b>S</b>	WORD	X, M, D, Z, UW, integer			☉				5
		Channel(Ch1, Ch2)							
		1 to 2							

**<Ladder>**

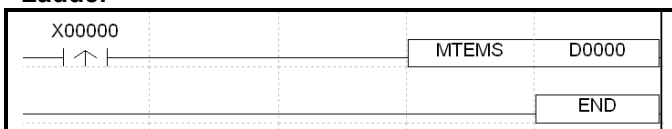

Emergency stop instruction: If there is emergency during motion position driving, you can stop all motion actions by emergency stop instruction.

[Note]

When executing emergency stop instruction, all currently executing motion instructions stop.

※ For more information, refer to Motion of SmartStudio user manual.

### 3.2.226 Motion instruction(MTCPP)

Motion instruction		MTCPP	S	S1	Applicable model				
					LP-S070				
OP	DATA type	Available device / Description / Range			Error	Zero	Carry	Borrow	Step
S	WORD	X, M, D, Z, UW, integer			<input type="checkbox"/>	<input type="checkbox"/>	<input type="checkbox"/>	<input type="checkbox"/>	5
		Channel(Ch1, Ch2)							
		1 to 2							
S1	DWORD	X, M, D, Z, UW, integer			<input checked="" type="checkbox"/>	<input type="checkbox"/>	<input type="checkbox"/>	<input type="checkbox"/>	
		Setting value of new position							
		-2,147,483,648 to 2,147,483,647							

<Ladder>

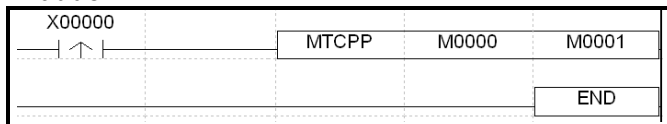

Current position preset instruction: This motion instruction is for re-set the current position.

[Note]

During motion driving, if this instruction is executed, error occurs.

※ For more information, refer to Motion of SmartStudio user manual.

### 3.2.227 Motion instruction(MTFOS)

Motion instruction		MTFOS	S	Applicable model					
				LP-S070					
OP	DATA type	Available device / Description / Range			Error	Zero	Carry	Borrow	Step
S	WORD	X, M, D, Z, UW, integer			☉				5
		Channel(Ch1, Ch2)							
		1 to 2							

<Ladder>

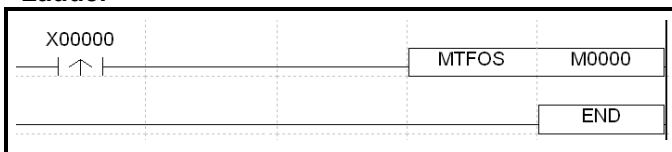

Forced home setting instruction: This instruction sets the specified position as the set home position value in SmartStudio.

※ For more information, refer to Motion of SmartStudio user manual.

### 3.2.228 Motion instruction(MTSRS)

Motion instruction		MTSRS	S	Applicable model					
				LP-S070					
OP	DATA type	Available device / Description / Range			Error	Zero	Carry	Borrow	Step
S	WORD	X, M, D, Z, UW, integer			☉				5
		Channel(Ch1, Ch2)							
		1 to 2							

<Ladder>

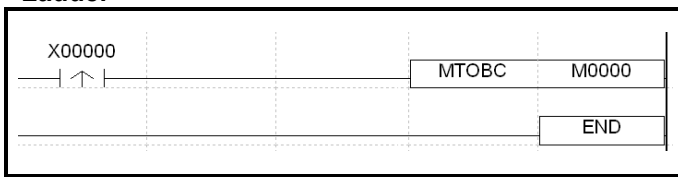

Normal stop instruction: It executes normal stop instruction to the currently motion driving channel.

**[Pattern stop method with combining special flag]**

1. F400 or F402 (Action list stop) + MTSRS  
: During pattern drive, if currently executed action list type is speed drive and this instruction is executed, speed drive is finish and it executes the next action list.
2. F401 or F403 (Group stop) + MTSRS  
: During group drive, this instruction is executed, it escapes the group and executes the other action list following the group.
3. Not to set special flag  
: Pattern drive is finish.
4. MTSRS during linear interpolation drive  
: Two axes decelerately stop at the same time.

※ For more information, refer to Motion of SmartStudio user manual.



### 3.2.229 Motion instruction(MTOBC)

Motion instruction		MTOBC	S	Applicable model					
				LP-S070					
OP	DATA type	Available device / Description / Range			Error	Zero	Carry	Borrow	Step
S	WORD	X, M, D, Z, UW, integer			⊙	□	□	□	5
		Channel(Ch1, Ch2)							
		1 to 2							

<Ladder>

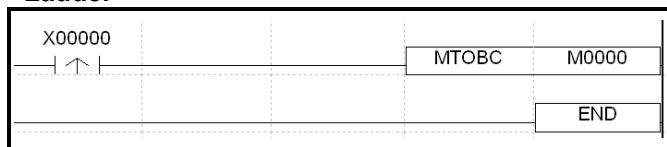

Origin back instruction: During motion position drive, if you want to return to origin, it goes back to the preset origin point.

LP-S070 has two methods for returning the origin.

- H/W origin back: It is the origin back method by home search direction, upper/lower H/W limit, and home sensing which are set in SmartStudio.
- S/W origin back: It is the origin back method to move directly to the known origin by S/W.

[Origin back type by home search direction during H/W origin back]

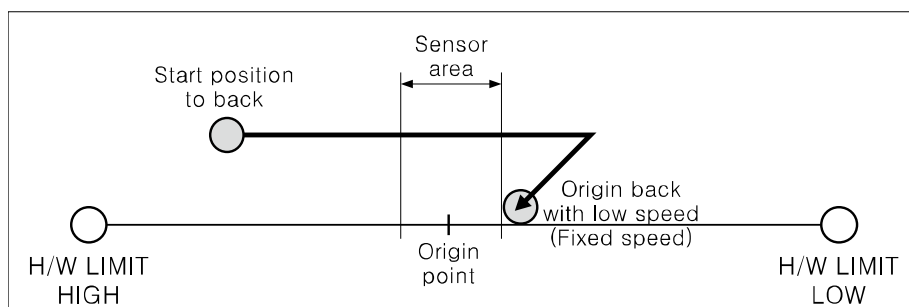
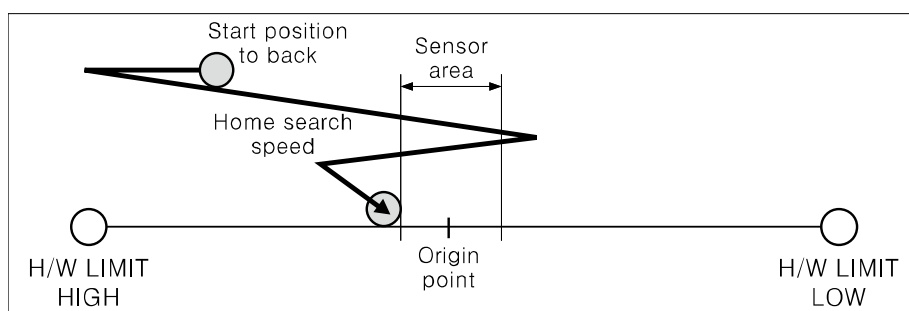
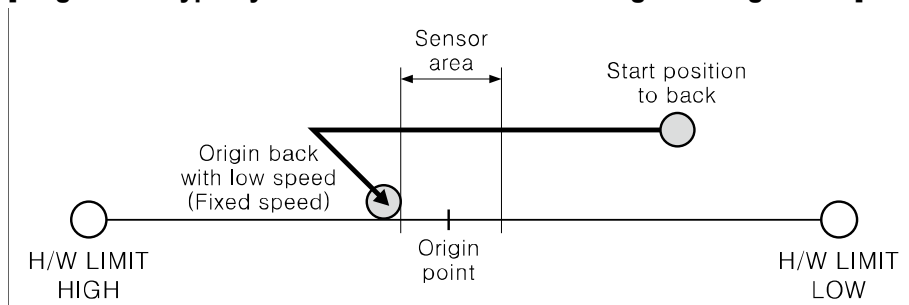

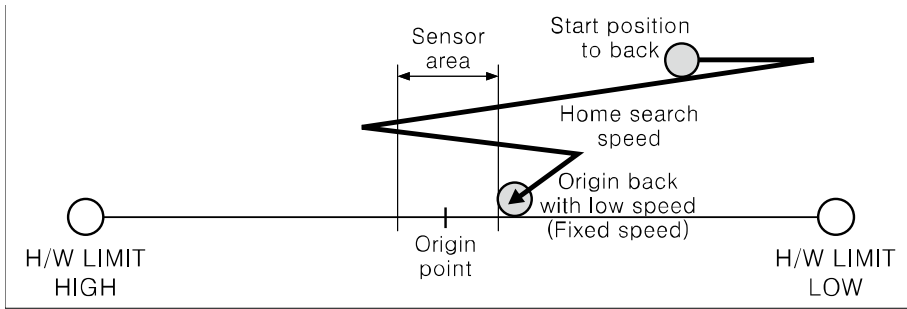

The position of the origin point is set in SmartStudio.

※ For more information, refer to Motion of SmartStudio user manual.

### 3.2.230 Motion instruction(MTOVV)

Motion instruction		MTOVV	S	S1	Applicable model				
					LP-S070				
OP	DATA type	Available device / Description / Range			Error	Zero	Carry	Borrow	Step
S	WORD	X, M, D, Z, UW, integer			☉				5
		Channel(Ch1, Ch2)							
		1 to 2							
S1	DWORD	X, M, D, Z, UW, integer							
		Drive speed							
		0 to 100kpps							

<Ladder>

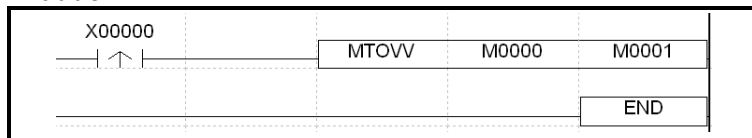

Speed override: It converts the currently operating speed set (unit set) to the other speed and operates with the converted speed.

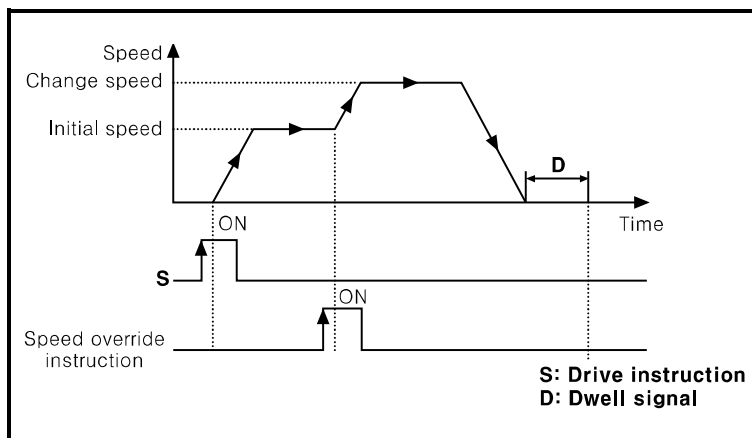

1. Operating speed  $\gg$  Chagned speed: It converts to changed speed and operates with the changed speed.
2. Operating speed  $\leq$  Changed speed: It converts to changed speed and operates with the changed speed.
3. Changed speed  $<$  Initial speed: When changing speed to the slower than initial speed, it operates constant speed drive without accel/deceleration.

[Note]

1. If the currently not operated channel is executed this instruction, position/speed override change error occurs.
2. If the currently operated channel is executed the other instruction, enable channel error occurs.
3. Be sure that rapid speed changing may cause the pull-out of motor.

※ For more information, refer to Motion of SmartStudio user manual.

### 3.2.231 Motion instruction(MTOVP)

OP	DATA type	Available device / Description / Range	Applicable model LP-S070				
<b>S</b>	WORD	X, M, D, Z, UW, integer	Error	Zero	Carry	Borrow	Step
		Channel(Ch1, Ch2)					
		1 to 2	⊙				5
<b>S1</b>	WORD	X, M, D, Z, UW, integer					
		Changed position					
		-2147483647 to 2147483647					

<Ladder>

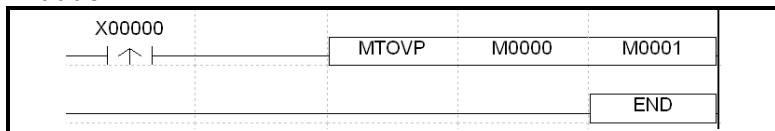

Position override: It changes the set target position to the designated position by the instruction.

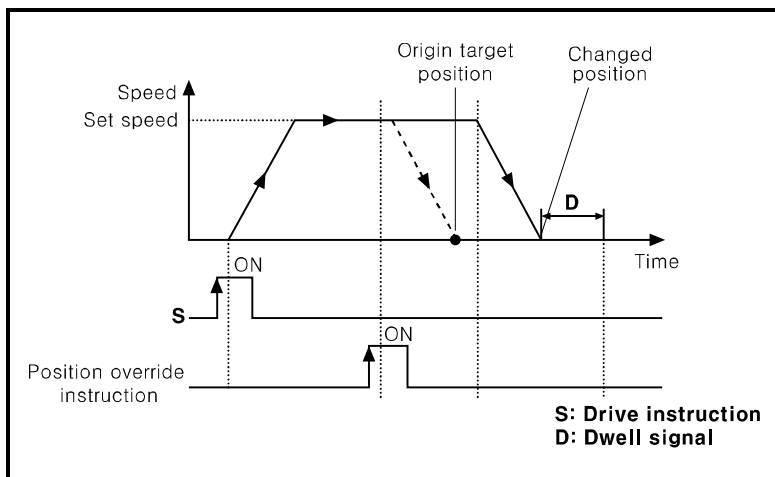

1. Current position  $\geq$  Changed position: It stops with deceleration.
2. Current position  $\ll$  Changed position: It stops with deceleration at the changed position.

[Note]

1. If the currently not operated channel is executed this instruction, position/speed override change error occurs.
2. If the currently operated channel is executed the other instruction, enable channel error occurs.

※ For more information, refer to Motion of SmartStudio user manual.

3.2.232 Motion instruction(MTIPT)

Motion instruction	MTIPT	S	S1	S4	S4	Applicable model				
						LP-S070				
OP	DATA type	Available device / Description / Range				Error	Zero	Carry	Borrow	Step
S	WORD	Integer				☉				7
		Channel number of the first axis(Ch1, Ch2)								
		1 to 2								
S1	WORD	X, M, D, Z, UW, integer								
		Action number of the first axis(it is not pattern number)								
		0 to 65535								
S3	WORD	Integer								
		Channel number of the second axis (Ch0, Ch1)								
		1 to 2								
S4	WORD	X, M, D, Z, UW, integer								
		Action number of the second axis(it is not pattern number)								
		0 to 65535								

<Ladder>

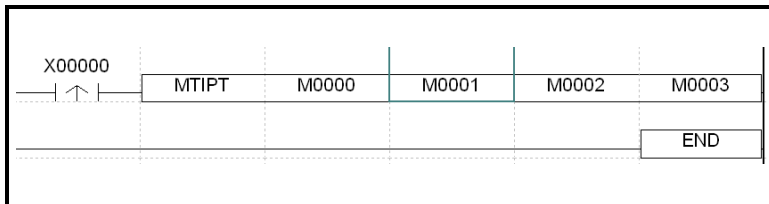

Line interpolation instruction: It executes line interpolation drive with two axes.

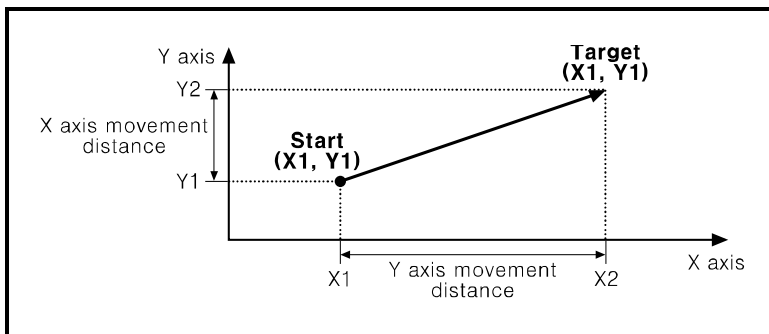

[Note]

1. The action list designated as speed drive is not available as the axis between line interpolation.
2. The axis which is more distance than the other is set as main axis.
3. Drive data of sub axis is decided by the calculating from the drive data of main axis.
4. If each distance of two axes is same, CH1 becomes main axis.

※ For more information, refer to Motion of SmartStudio user manual.

### 3.2.233 Motion instruction(MTUAI)

Motion instruction	MTUAI	S	S1	Applicable model LP-S070					
<b>OP</b>	<b>DATA type</b>	<b>Available device / Description / Range</b>			<b>Error</b>	<b>Zero</b>	<b>Carry</b>	<b>Borrow</b>	<b>Step</b>
<b>S</b>	WORD	X, M, D, Z, UW, integer			<input type="checkbox"/>	<input type="checkbox"/>	<input type="checkbox"/>	<input type="checkbox"/>	5
		Channel(Ch1, Ch2)							
		1 to 2							
<b>S1</b>	WORD	X, M, D, Z, UW, integer			<input checked="" type="checkbox"/>	<input type="checkbox"/>	<input type="checkbox"/>	<input type="checkbox"/>	
		Step number							
		1 to 99							

<Ladder>

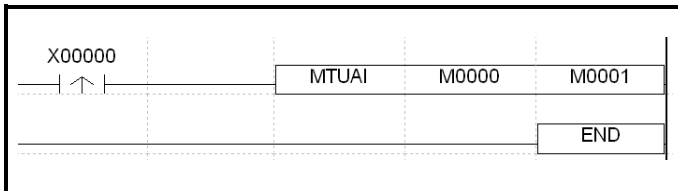

Action item drive instruction

: It operates one action of motion referring the number of action item.

[Note]

1. For utilize indirect drive instruction, set 'TRUE' at 'Enable Ch' of common configuration from [Parameter]-[MOTION]tab in SmartStudio.
  2. There should be pattern number to execute of pattern list from from [Parameter]-[MOTION]tab in SmartStudio.
  3. If the currently operated channel is executed the other instruction, enable channel error occurs..
- ※ For more information, refer to Motion of SmartStudio user manual.



# Autonics

Sensors & Controllers

www.autonics.com

## Distributor



### ■ Major Products

·Photoelectric Sensors·Fiber Optic Sensors·Door Sensors·Door Side Sensors·Area Sensors  
·Proximity Sensors·Pressure Sensors·Connectors/Sockets·Rotary Encoders·Panel Meters  
·Counters·Timers·Temperature Controllers·SSRs/Power Controllers·Sensor Controllers  
·Graphic/Logic Panels·Temperature/Humidity Transducers·Switching Mode Power Supplies  
·Stepper Motors/Drivers/Motion Controllers·I/O Terminal Blocks & Cables·Display Units  
·Control Switches·Lamps/Buzzers·Field Network Devices·Tachometer/Pulse(Rate) Meters  
·Laser Marking System(Fiber, CO<sub>2</sub>, Nd:YAG)·Laser Welding/Cutting System

■ Any proposal for a product improvement and development: [Product@autonics.com](mailto:Product@autonics.com)

### ■ Corporate Headquarters

18, Bansong-ro 513 Beon-gil, Haeundae-gu, Busan, South Korea 48002

### ■ Brazil - Autonics do Brasil Comercial Importadora e Exportadora LTDA

Tel: 55-11-2307-8480 / 3195-4610 / Fax: 55-11-2309-7784 / E-mail: [comercial@autonics.com.br](mailto:comercial@autonics.com.br)

### ■ China - Autonics electronic(Jiaxing) Corporation

Tel: 86-21-5422-5969 / Fax: 86-21-5422-5961 / E-mail: [china@autonics.com](mailto:china@autonics.com)

### ■ India - Autonics Automation India Private Limited

Tel: 91-22-2768-2570 / E-mail: [india@autonics.com](mailto:india@autonics.com)

### ■ Indonesia - PT. Autonics Indonesia

Tel: 62-21-8088-8814/5 / Fax: 62-21-8088-4442/0 / E-mail: [indonesia@autonics.com](mailto:indonesia@autonics.com)

### ■ Iran - Autonics Corp. Iran Representative Office

Tel: 98-21-8872-7251/2 / Fax: 98-21-8872-8556 / E-mail: [iran@autonics.com](mailto:iran@autonics.com)

### ■ Japan - Autonics Japan Corporation

Tel: 81-3-6435-8380 / Fax: 81-3-6435-8381 / E-mail: [ja@autonics.com](mailto:ja@autonics.com)

### ■ Malaysia - Mal-Autonics Sensor Sdn. Bhd.

Tel: 60-3-7805-7190 / Fax: 60-3-7805-7193 / E-mail: [malaysia@autonics.com](mailto:malaysia@autonics.com)

### ■ Mexico - Autonics Mexico S.A. DE C.V

Tel: 52-55-5207-0019 / Fax: 52-55-1663-0712 / E-mail: [ventas@autonics.com.mx](mailto:ventas@autonics.com.mx)

### ■ Russia - Autonics Rus LLC

Tel/Fax: 7-495-660-10-88 / E-mail: [russia@autonics.com](mailto:russia@autonics.com)

### ■ Turkey - Autonics Otomasyon Ticaret Ltd. Sti.

Tel: 90-216-365-9117/3/4 / Fax: 90-216-365-9112 / E-mail: [turkey@autonics.com](mailto:turkey@autonics.com)

### ■ USA - Autonics USA, Inc.

Tel: 1-847-680-8160 / Fax: 1-847-680-8155 / E-mail: [sales@autonicsusa.net](mailto:sales@autonicsusa.net)

### ■ Vietnam - Cong Ty TNHH Autonics Vina

Tel: 84-28-3771-2662 / Fax: 84-28-3771-2663 / E-mail: [vietnam@autonics.com](mailto:vietnam@autonics.com)