

Autonics

THIN TYPE AREA SENSOR BWP SERIES

INSTRUCTION MANUAL



Thank you for choosing Autonics product.
Please read the following safety considerations before use.

■ Safety Considerations

※Please observe all safety considerations for safe and proper product operation to avoid hazards.
※▲ symbol represents caution due to special circumstances in which hazards may occur.

- ▲Warning Failure to follow these instructions may result in serious injury or death.
- ▲Caution Failure to follow these instructions may result in personal injury or product damage.

▲ Warning

- Fail-safe device must be installed when using the unit with machinery that may cause serious injury or substantial economic loss. (e.g. nuclear power control, medical equipment, ships, vehicles, railways, aircraft, combustion apparatus, safety equipment, crime/disaster prevention devices, etc.)
Failure to follow this instruction may result in fire, personal injury, or economic loss.
- Do not connect, repair, or inspect the unit while connected to a power source.
Failure to follow this instruction may result in fire.
- Check 'Connections' before wiring.
Failure to follow this instruction may result in fire.
- Do not disassemble or modify the unit.
Failure to follow this instruction may result in fire.
- This product is not safety sensor and does not observe any domestic nor international safety standard.
Do not use this product with the purpose of injury prevention or life protection, as well as in the place where economic loss may be present.

▲ Caution

- Use the unit within the rated specifications.
Failure to follow this instruction may result in fire or product damage.
- Use dry cloth to clean the unit, and do not use water or organic solvent.
Failure to follow this instruction may result in fire.
- Do not use the unit in the place where flammable/explosive/corrosive gas, humidity, direct sunlight, radiant heat, vibration, impact, or salinity may be present.
Failure to follow this instruction may result in fire or explosion.
- Do not use a load over the range of rated relay specification.
Failure to follow this instruction may result in insulation failure, contact melt, contact failure, relay broken, or fire.

■ Structure

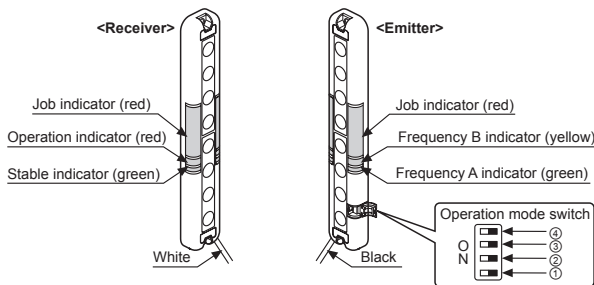

○ Operation mode switch

No.	Function	Switch OFF	Switch ON
①	Selection of transmission frequency	Frequency A	Frequency B
②	Light ON/Dark ON selection	Light ON operation	Dark ON operation
③	Selection light/flashing for Job indicator	Job indicator light	Job indicator flashing
④	Selection of JOB/TEST	NORMAL mode	TEST mode

■ Timing Diagram Operation

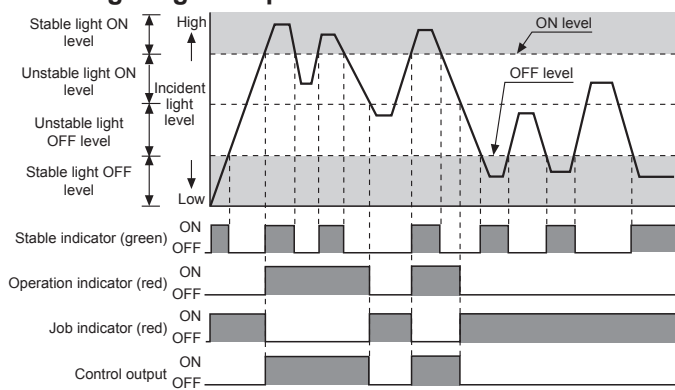

※The waveforms of operation indicator, job indicator, and control output are the state of operation for Light ON, but in case of Dark ON, it is opposite operation against Light ON mode.

■ Operation Indicator

Item	Emitter Indicator			Receiver Indicator			Control output
	Green	Yellow	Job indicator	Green	Red	Job indicator	
Power ON	●	●	—	—	—	—	—
FREQ. A operation	●	—	—	—	—	—	—
FREQ. B operation	—	●	—	—	—	—	—
TEST	●	●	●	●	●	●	OFF
Stable light ON	—	—	●	●	●	●	ON
Unstable light ON	—	—	●	●	●	●	ON
Unstable light OFF	—	—	●	●	●	●	OFF
Stable light OFF	—	—	●	●	●	●	OFF
Flashing function ON	—	—	●	●	●	●	OFF
Synchronous line malfunction	—	—	●	●	●	●	OFF
Over current	—	—	●	●	●	●	OFF

Display classification list	
●	Lighting
○	Light out
⬇	Flashing by 0.3 sec
⬇⬇	Flashing simultaneously by 0.3 sec
⬇⬇	Cross-flashing by 0.3 sec

※The operation of 'Operation indicator (red)', 'Job indicator (red)', 'Control output' is for Light ON, in case of Dark ON, it is opposite operation against Light ON.
(In case, malfunction of synchronous line and over current, control output is OFF regardless of the mode.)

※The above specifications are subject to change and some models may be discontinued without notice.
※Be sure to follow cautions written in the instruction manual and the technical descriptions (catalog, homepage).

■ Ordering Information

BWP 20 - 08 T P	Output	No-mark	NPN open collector output
	Emitter/Receiver	P	PNP open collector output
		T	Emitter
		R	Receiver
	Number of optical axis	08 to 20	8 to 20
	Optical axis pitch	20	20mm pitch
	Item	BWP	Plastic case area sensor

※ This information is intended for product management. (no need to refer when selecting a model)

■ Specifications

Model	NPN open collector output	BWP20-08	BWP20-12	BWP20-16	BWP20-20
	PNP open collector output	BWP20-08P	BWP20-12P	BWP20-16P	BWP20-20P
Sensing type	Through-beam type				
Sensing distance	0.1 to 5m				
Sensing target	Opaque materials of min. Ø30mm				
Optical axis pitch	20mm				
Number of optical axis	8	12	16	20	
Sensing width	140mm	220mm	300mm	380mm	
Power supply	12-24VDC ±10% (ripple P-P: max. 10%)				
Current consumption	Emitter: max. 80mA, receiver: max. 80mA				
Control output	NPN or PNP open collector output • Load voltage: max. 30VDC • Residual voltage - NPN: max. 1VDC, PNP: max. 2.5VDC • Load current: max. 150mA				
Protection circuit	Reverse polarity protection circuit, output short over current protection circuit				
Operation mode	Switching of Light ON/Dark ON by switch				
Response time	Max. 6ms (frequency B selection is max. 7ms)				
Light source	Infrared LED (850nm modulated)				
Synchronization type	Timing method by synchronous line				
Interference protection	Interference protection by transmission frequency selection				
Environment	Ambient illumination	Ambient light: max. 10,000lx (received light side illumination)			
	Ambient temperature	-10 to 55°C, storage: -20 to 60°C			
	Ambient humidity	35 to 85%RH, storage: 35 to 85%RH			
Noise immunity	±240V the square wave noise (pulse width 1µs) by the noise simulator				
Dielectric strength	1,000VAC 50/60Hz for 1 minute				
Insulation resistance	Over 20MΩ (at 500VDC megger)				
Vibration	1.5mm amplitude at frequency of 10 to 55Hz in each X, Y, Z direction for 2 hours				
Shock	500m/s ² (approx. 50G) in each X, Y, Z direction for 3 times				
Protection structure	IP40 (IEC standard)				
Material	Case: Polycarbonate/Acrylonitrile-Butadiene-Styrene, Sensing part: Polymethyl methacrylate				
Cable	Ø3.5mm, 4-wire, 3m (AWG24, core diameter: 0.08mm, number of cores: 40, insulator diameter: Ø1mm)				
Approval	CE				
Weight ^{※1}	Approx. 480g (approx. 280g)	Approx. 520g (approx. 320g)	Approx. 620g (approx. 360g)	Approx. 680g (approx. 430g)	

※1: The weight includes packaging. The weight in parenthesis is for unit only.
※The temperature or humidity mentioned in Environment indicates a non freezing or condensation.

■ Dimensions

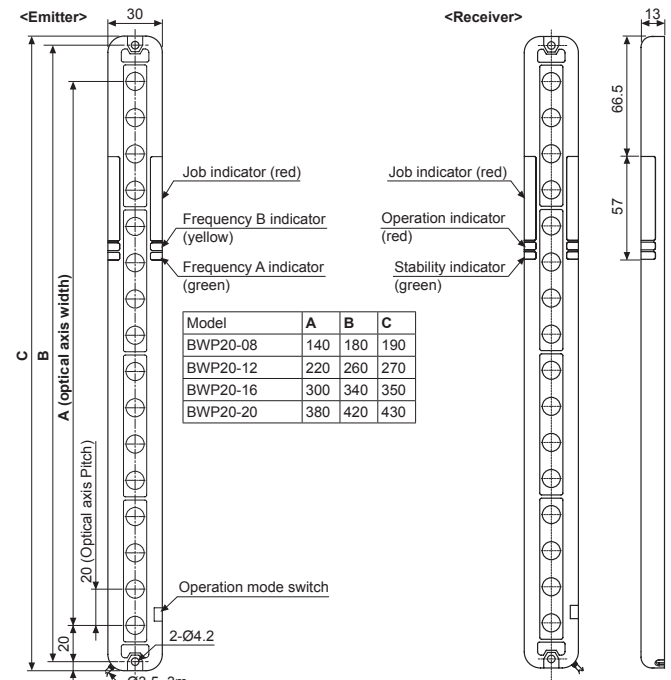

※Please use bolt M4 for mounting of sensor, set the tightening torque under 2N·m.

■ Bracket: sold separately

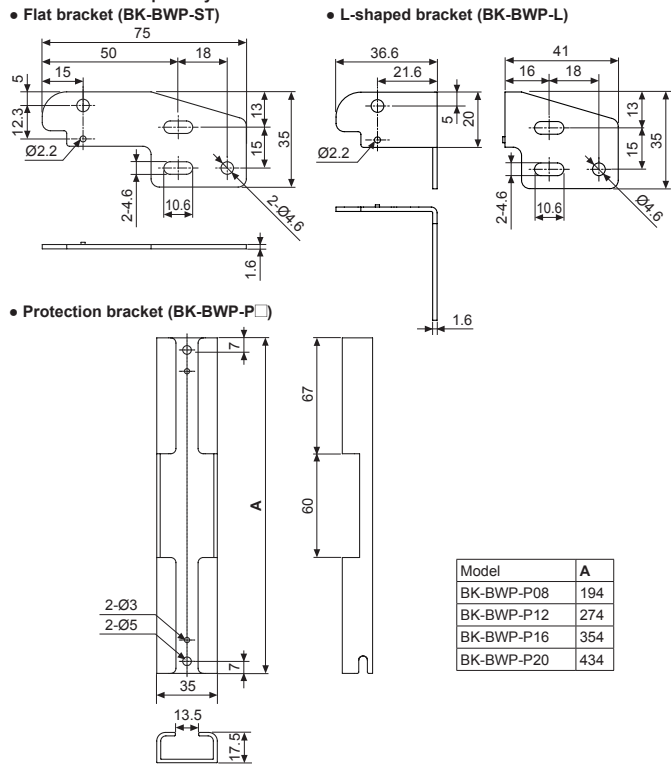

■ Input/Output Circuit and Connection Diagram

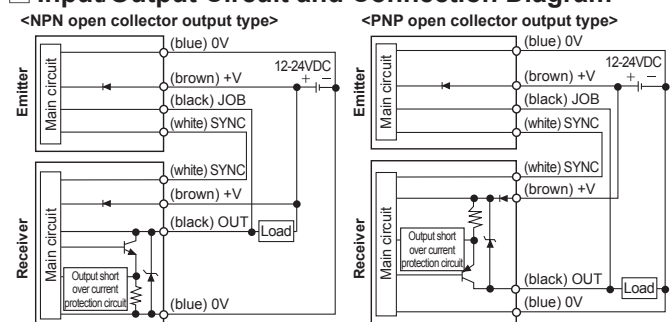

※If the receiver OUT (black) line and the emitter JOB (black) line are not connected each other, the job indicator of the emitter is not operated and maintains the light status.

■ Installations

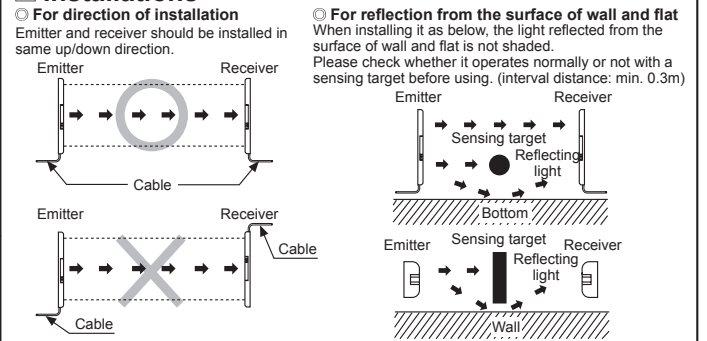

○ For direction of installation
Emitter and receiver should be installed in same up/down direction.

○ For reflection from the surface of wall and flat
When installing it as below, the light reflected from the surface of wall and flat is not shaded. Please check whether it operates normally or not with a sensing target before using. (interval distance: min. 0.3m)

○ For protection of interference
It may cause interference when installing more than 2 sets of the sensor. In order to avoid the interference of the sensor, please install as following figures and use the interference protection function.

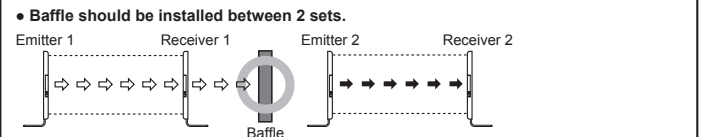
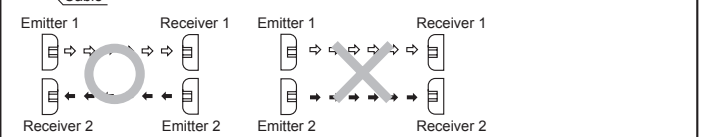
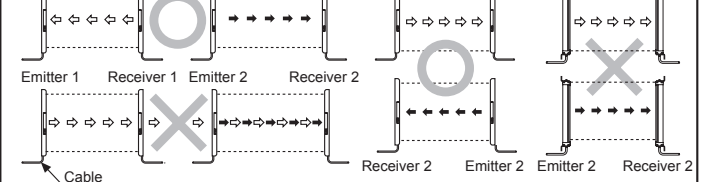

※It may be a little different based on installation environment.
※Avoid using the unit in the place where the sensor is exposed directly to the fluorescent light with high speed start or high frequency.

○ Interference protection
In case of using 2 of sensor in serial or parallel in order to extend sensing width, it may cause sensing error because of light interference. This function is operating a sensor in transmission frequency A and another sensor in transmission frequency B to avoid these sensing errors by the light interference.

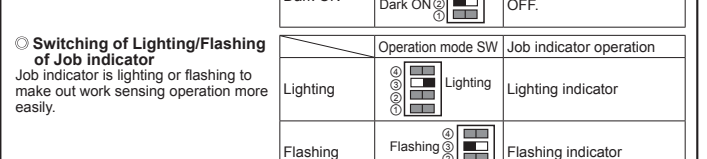
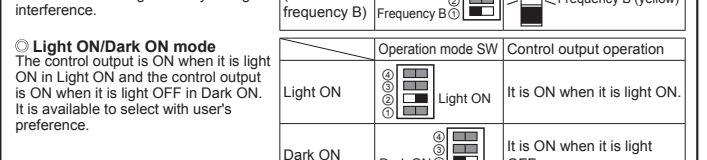
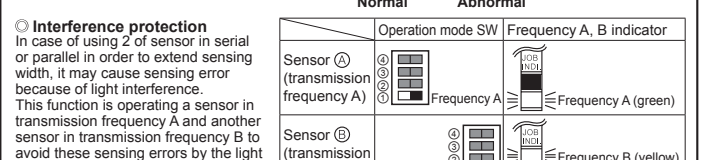
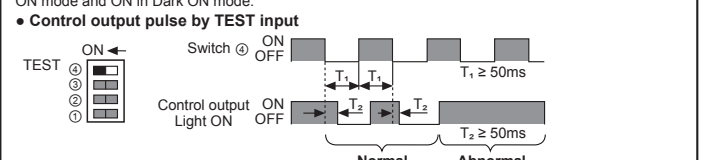
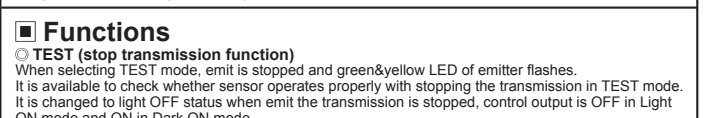

■ Troubleshooting

Malfunction	Cause	Troubleshooting
Non-operation	Power supply Cable incorrect connection or disconnection Rated connection failure	Supply rated power. Check the wiring. Use it within rated sensing distance.
Non-operation in sometimes	Pollution by dirt of sensor cover Cable connection failure	Remove dirt by soft brush or cloth. Check the assembled part of the cable.
Control output is OFF even though there is not a target object.	Out of rated sensing distance There is an obstacle to cut off the light emitted between emitter and receiver There is a strong electric wave or noise generator such as motor, electric generator, high voltage line etc.	Remove the obstacle. Put away the strong electric wave or noise generator.
LED displays for synchronous line malfunction	Synchronous line incorrect connection or disconnection Break of synchronous circuit of emitter or receiver	Check the wiring. Contact our company.
LED displays for over current	Control output line is shorten Over load	Check the wiring. Check the rated load capacity.

■ Cautions during Use

- Follow instructions in 'Cautions during Use'. Otherwise, it may cause unexpected accidents.
- 12-24VDC power supply should be insulated and limited voltage/current or Class 2, SELV power supply device.
- Use the product, 1 sec after supplying power.
When using separate power supply for the sensor and load, supply power to sensor first.
- When using switching mode power supply to supply the power, ground F.G. terminal and connect a condenser between 0V and F.G. terminal to remove noise.
- When connecting a DC relay or other inductive load, remove surge by using diodes or varistors.
- Wire as short as possible and keep away from high voltage lines or power lines, to prevent surge and inductive noise.
- This unit may be used in the following environments.
①Indoors (in the environment condition rated in 'Specifications')
②Altitude max. 2,000m
③Pollution degree 2
④Installation category II

■ Major Products

■ Photoelectric Sensors	■ Temperature Controllers
■ Fiber Optic Sensors	■ Temperature/Humidity Transducers
■ Door Sensors	■ SSR/Power Controllers
■ Door Side Sensors	■ Counters
■ Area Sensors	■ Timers
■ Proximity Sensors	■ Panel Meters
■ Pressure Sensors	■ Tachometer/Pulse (Rate) Meters
■ Rotary Encoders	■ Display Units
■ Connector/Sockets	■ Sensor Controllers
■ Switching Mode Power Supplies	
■ Control Switches/Lamps/Buzzers	
■ I/O Terminal Blocks & Cables	
■ Stepper Motors/Drivers/Motion Controllers	
■ Graphic/Logic Panels	
■ Field Network Devices	
■ Laser Marking System (Fiber, Co., Nd: YAG)	
■ Laser Welding/Cutting System	

Autonics Corporation
http://www.autonics.com

■ HEADQUARTERS:
18, Bansong-ro 513 beon-gil, Haundae-gu, Busan, South Korea, 48002
TEL: 82-51-519-3232
E-mail: sales@autonics.com