

Autonics

Photoelectric Sensor BM SERIES

INSTRUCTION MANUAL



Thank you for choosing our Autonics product.
Please read the following safety considerations before use.

■ Safety Considerations

- ⚠ Please observe all safety considerations for safe and proper product operation to avoid hazards.
- ⚠ symbol represents caution due to special circumstances in which hazards may occur.
- Warning** Failure to follow these instructions may result in serious injury or death.
- Caution** Failure to follow these instructions may result in personal injury or product damage.

⚠ Warning

- Fail-safe device must be installed when using the unit with machinery that may cause serious injury or substantial economic loss.** (e.g. nuclear power control, medical equipment, ships, vehicles, railways, aircraft, combustion apparatus, safety equipment, crime/disaster prevention devices, etc.)
Failure to follow this instruction may result in personal injury, economic loss or fire.
- Do not use the unit in the place where flammable/explosive/corrosive gas, high humidity, direct sunlight, radiant heat, vibration, impact, or salinity may be present.**
Failure to follow this instruction may result in explosion or fire.
- Do not disassemble or modify the unit.**
Failure to follow this instruction may result in fire.
- Do not connect, repair, or inspect the unit while connected to a power source.**
Failure to follow this instruction may result in fire.
- Check 'Connections' before wiring.**
Failure to follow this instruction may result in fire.

⚠ Caution

- Use the unit within the rated specifications.**
Failure to follow this instruction may result in fire or product damage.
- Use a dry cloth to clean the unit, and do not use water or organic solvent.**
Failure to follow this instruction may result in fire.

■ Ordering Information

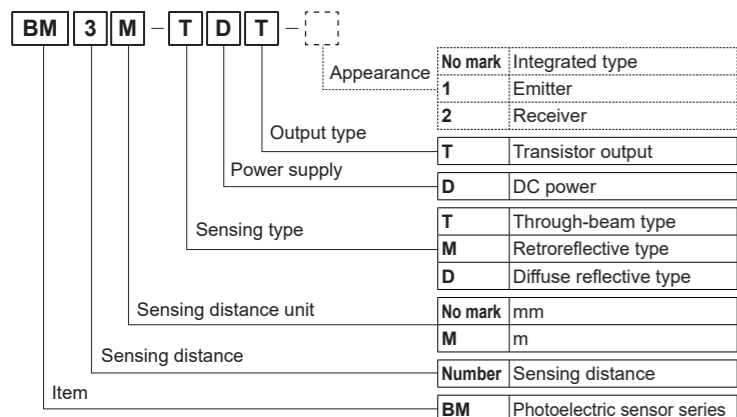

⚠ The above specifications are subject to change and some models may be discontinued without notice.
⚠ Be sure to follow cautions written in the instruction manual and the technical descriptions (catalog, homepage).

■ Specifications

Model	BM3M-TDT	BM1M-MDT	BM200-DDT
Sensing type	Through-beam	Retroreflective	Diffuse reflective
Sensing distance	3m	1m*1	200mm*2
Sensing target	Opaque materials over Ø8mm	Opaque materials of over Ø60mm	Transparent, translucent, opaque materials
Hysteresis	—	—	Max. 10% at sensing distance
Response time	Max. 3ms	—	—
Power supply	12-24VDC±10% (ripple P-P: max. 10%)		
Current consumption	Max. 45mA	Max. 40mA	—
Light source	Infrared LED (940nm)		
Sensitivity adjustment	Fixed	—	Sensitivity adjuster
Operation mode	Dark ON	—	Light ON (Dark ON: option)
Control output	NPN open collector output Load voltage: max. 30VDC, load current: max. 100mA, residual voltage: max. 1VDC		
Protection circuit	Power reverse polarity protection circuit		
Indication	Operation indicator: red LED		
Connection	Cable type		
Insulation resistance	Over 20MΩ (at 500VDC megger)		
Noise immunity	±240V the square wave noise (pulse width: 1μs) by the noise simulator		
Dielectric strength	1,000VAC 50/60Hz for 1 minute		
Vibration	1.5mm amplitude at frequency of 10 to 55Hz in each X, Y, Z direction for 2 hours		
Shock	500m/s ² (approx. 50G) in each X, Y, Z direction for 3 times		
Environment	Ambient illumination	Sunlight: max. 11,000lx, incandescent lamp: max. 3,000lx (receiver illumination)	
	Ambient temperature	-10 to 60°C, storage: -25 to 70°C	
	Ambient humidity	35 to 85%RH, storage: 35 to 85%RH	
Material	Case	acrylonitrile butadiene styrene, sensing part: polycarbonate, bracket: steel plate cold commercial, bolt, nut: steel chromium molybdenum	Case: acrylonitrile butadiene styrene, sensing part: acrylic, bracket: steel plate cold commercial, bolt, nut: steel chromium molybdenum
	Cable	Ø4mm, 3-wire, 2m (emitter of through-beam type: Ø4mm, 2-wire, 2m) (AWG22, core diameter: 0.08mm, number of cores: 60, insulator out diameter: Ø1.25mm)	
Accessories	Individual	—	Reflector (MS-2) Adjuster driver
	Common	Fixing bracket, M4 bolt: 4, M4 nut: 4	Fixing bracket, M4 bolt: 2, M4 nut: 2
Approval	CE		
Weight*3	Approx. 240g (approx. 170g)	Approx. 188g (approx. 105g)	Approx. 156g (approx. 88g)

- *1: The sensing distance is specified with using the MS-2 reflector, and it is the same when using MS-5 (sold separately). The distance between the sensor and the reflector should be set over 0.1m. When using reflective tapes, the reflectivity will vary by size of the tape. Please refer to the catalog or web site.
- *2: Non-glossy white paper 200×200mm.
- *3: The weight includes packaging. The weight in parenthesis is for unit only.
- *The temperature or humidity mentioned in Environment indicates a non freezing or condensation.

■ Dimension

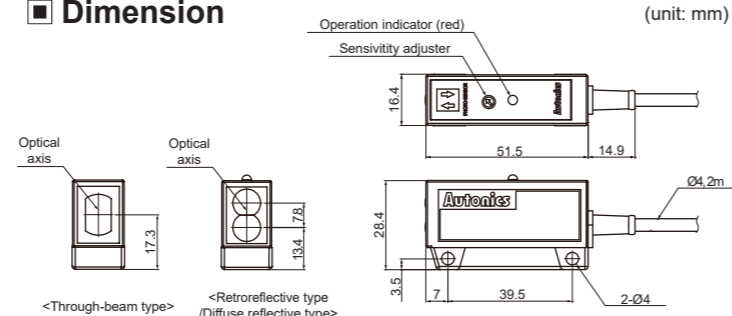

○ Bracket

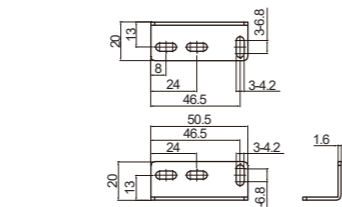

○ Reflector (MS-2)

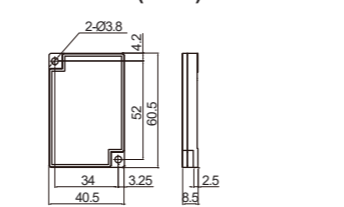

■ Connection

○ Through-beam type

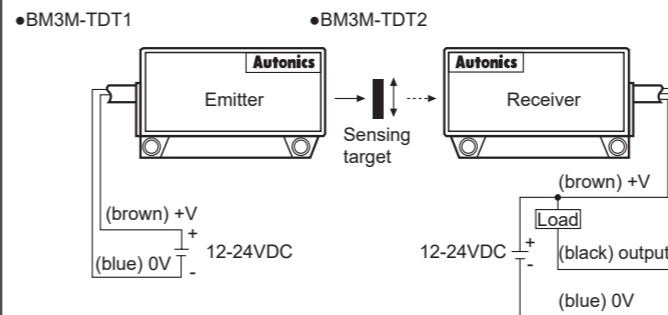

○ Retroreflective type

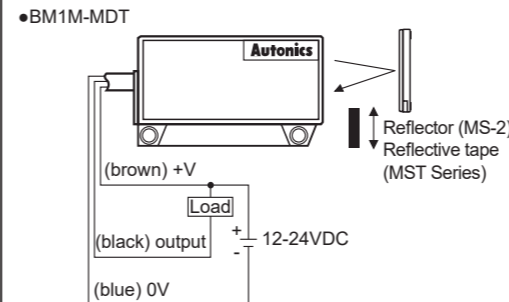

○ Diffuse reflective type

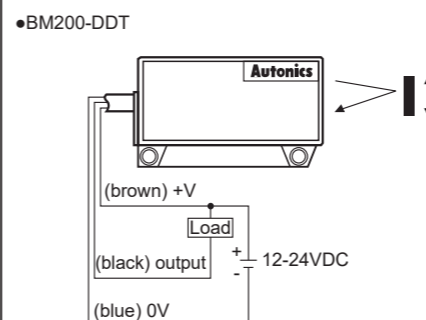

■ Operation Mode

Operation mode	Light ON	Dark ON
Receiver operation	Received light Interrupted light	
Operation indicator (red LED)	ON OFF	ON OFF
Transistor output	ON OFF	ON OFF

■ Control Output Circuit Diagram

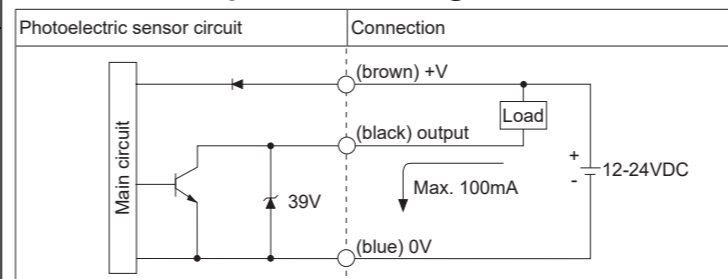

⚠ The product is not equipped with the output short over current protection circuit. If short-circuit the control output terminal or supply current over the rated specification, it may result in product damage.

○ Reflector (MS-5, sold separately)

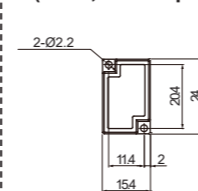

○ Reflective tape (MST Series, sold separately)

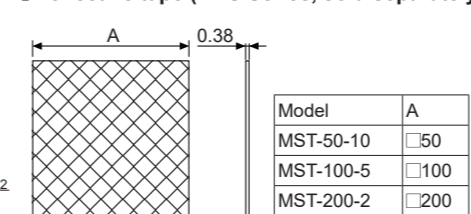

Model	A
MST-50-10	□50
MST-100-5	□100
MST-200-2	□200

■ Installation and Adjustment

○ For installation

When using photoelectric sensors closely over two units, it may result in malfunction due to mutual interference. When installing the product, tighten the screw with a tightening torque of 0.8 N.m. Do not impact on the unit with the hard object or bend the cable with excessive power. Otherwise, it may result in damage to the waterproof function.

○ For optical axis adjustment

- Through-beam type
 - Supply the power to the photoelectric sensor, after setting the emitter and the receiver facing each other.
 - Set the receiver in center of position in the middle of the operation range of indicator by adjusting the receiver or the emitter right and left, up and down.
 - After the adjustment, check the stability of operation by putting the object at the optical axis.
- ⚠ If the sensing target is translucent body or smaller than Ø8mm, it can be missed by sensor because light penetrate it.

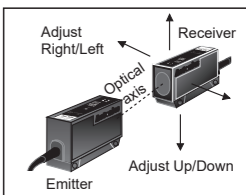

● Retroreflective type

- Supply the power to the photoelectric sensor, after setting the photoelectric sensor and the reflector (MS-2) or reflective tape face to face.
 - Set the photoelectric sensor in the position which indicator turns on, by adjusting the reflector, reflective tape or the sensor right and left, up and down.
 - Fix both units tightly after checking that the unit detects the target.
- ⚠ If using more than 2 photoelectric sensors in parallel, the space between each of them should be more than 30cm.
 - ⚠ If reflectance of target is higher than non-glossy white paper, it might cause malfunction by reflection from the target when the target is near to photoelectric sensor. Therefore put enough space between the target and the photoelectric sensor or the surface of the target should be installed at angle of 30° to 45° against optical axis.
 - ⚠ If the mounting place is too narrow, please use the reflector (MS-5) instead of the reflector (MS-2).
 - ⚠ Please use reflective tape (MST series) for the place where the reflector cannot be installed.

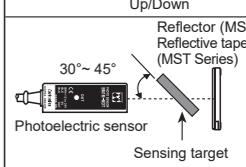
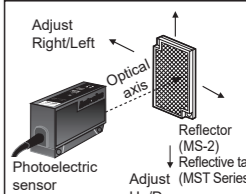

● Diffuse reflective type

- The sensitivity should be adjusted depending on a sensing target or mounting place.
 - Set the target at a position to be detected by the beam, then turn the sensitivity adjuster until position ① where the operation indicator turns ON from MIN position of the sensitivity adjuster.
 - Take the target out of the sensing area, then turn the sensitivity adjuster until position ② where the operation indicator turns ON. If the indicator does not turn ON, MAX position is ③.
 - Set the sensitivity adjuster at the center of two switching position ①, ②.
- ⚠ The sensing distance indicated on specification chart is for 200×200mm of non-glossy white paper. Be sure that it can be different by size, surface and gloss of target.

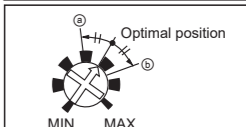
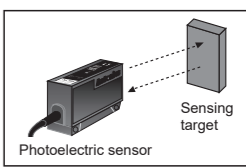

■ Cautions during Use

- Follow instructions in 'Cautions during Use'. Otherwise, It may cause unexpected accidents.
- When connecting a DC relay or other inductive load to the output, remove surge by using diodes or varistors.
- Use the product, 0.5 sec after supplying power. When using separate power supply for the sensor and load, supply power to sensor first.
- Power supply should be insulated and limited voltage/current or Class 2, SELV power supply device.
- Wire as short as possible and keep away from high voltage lines or power lines, to prevent inductive noise.
- When using switching mode power supply to supply the power, ground F.G. terminal and connect a condenser between 0V and F.G. terminal to remove noise.
- When using sensor with the equipment which generates noise (switching regulator, inverter, servo motor, etc.), ground F.G. terminal of the equipment.
- This unit may be used in the following environments.
 - ①Indoors (in the environment condition rated in 'Specifications')
 - ②Altitude max. 2,000m
 - ③Pollution degree 3
 - ④Installation category II

■ Major Products

- Photoelectric Sensors
- Fiber Optic Sensors
- Door Sensors
- Area Sensors
- Proximity Sensors
- Pressure Sensors
- Rotary Encoders
- Connectors/Sockets
- Switching Mode Power Supplies
- Control Switches/Lamps/Buzzers
- I/O Terminal Blocks & Cables
- Stepper Motors/Drivers/Motion Controllers
- Graphic/Logic Panels
- Field Network Devices
- Laser Marking System (Fiber, CO₂, Nd: YAG)
- Laser Welding/Cutting System
- Temperature Controllers
- Temperature/Humidity Transducers
- SSRs/Power Controllers
- Counters
- Timers
- Panel Meters
- Tachometer/Pulse (Rate) Meters
- Display Units
- Sensor Controllers

Autonics Corporation
http://www.autonics.com

HEADQUARTERS:
18, Bansong-ro 513 beon-gil, Haeundae-gu, Busan, South Korea, 48002
TEL: 82-51-519-3232
E-mail: sales@autonics.com