

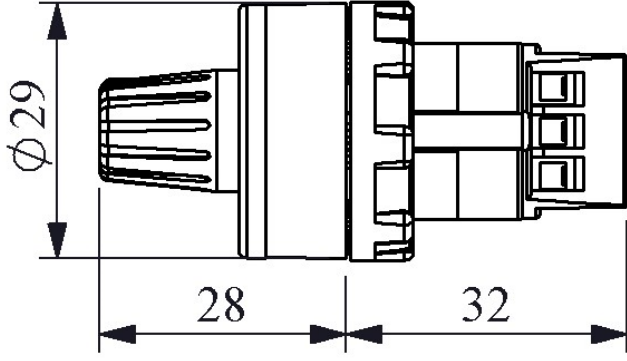

BPR05K

Product	Potentiometer
Dia	22 mm
Dielectric Strength (Contact-Contact)	1750 Vrms
Isolation Resistance	10 MΩ min. (500V DC)
Operating Temperature	-15 / + 80 °C
Pollution Degree	3
Protection Degree	IP65
Cable Section	0.75-1.5 mm ²
Screw Torque	1,5 Nm
Maximum Current	17,30 mA
Maximum Power	1,5 W (70°C)
Resistive Value	5 kΩ
Spin Angle	270°
Production Time	31.12.1899 00:00:00
Serial	B Series Plastic
Specifications	Non-flammable V0 PA6.6
	Variety of impedances
	IP65 protection from front side
Standards / Certificates	IEC 60393-1



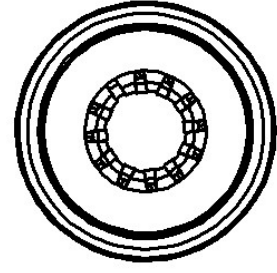

Montaj Ölçüsü $\phi 22.4 \pm 0.2$ mm



Devre Şeması

