

Table of Contents

1. Statement	1
2. Safety statement	1
3. Safety information	2
4. Safety symbols.....	2
5. Cautions for Operation.....	3
6. General information.....	4
7. Functional features:	5
8. Description of the meter's panel	6
9. LCD interface.....	8
10. Measurement method.....	9
10.1 Pre-measurement considerations.....	9
10.2 Working principle	10
10.3 Typical operations.....	10
11. Specific applications.....	12
11.1 Measuring range manual switchover mode	12
11.2 Relative value/peak value measurement mode	14
11.3 Max/min value query mode.....	16
11.4 Data hold/zero calibration mode.....	17
11.5 Light source selection mode.....	18

12. Other functions available.....	20
12.1 Mute	20
12.2 Auto shutdown	20
13 Technical data	20
14. Repair & Maintenance.....	21
14.1 Repair	21
14.2 Cleaning	22
14.3 Battery replacement	23
14.4 Calibration interval	23
15. Reference illuminance values for various locations.....	24

1. Statement

Unless otherwise permitted and agreed in writing, no part of this Operation Manual shall be copied in any form in accordance with International Copyright Law.

This Operation Manual is subject to change without notice from time to time in the future versions.

2. Safety statement



The symbol "Caution" implies that the current condition and operation may damage the meter or equipment.

It requires the operator to operate the meter or device with great care. Any misoperation or any inconformity with these operational steps may lead to the damaged meter or equipment. The operator shall not continue to implement any operations indicated by the symbol "Caution" if he fails to meet all these conditions or understand fully the operational guidelines.



The symbol "Warning" implies that the current condition and operation will place the operator in danger.

It requires the operator to operate the meter or device with great care. Any misoperation or any inconformity with these operational steps may lead to personal injuries or deaths. The operator shall not continue to implement any operations indicated by the symbol "Warning" if he fails to meet all these conditions or understand fully the operational guidelines.

Please read carefully this Operation Manual and pay attention to warning information before operating this meter.

3. Safety information



Do not attempt to operate this meter in an environment with explosive gas substances, combustible vapor substances and full of dust!

4. Safety symbols

This Operation Manual contains the basic information on safe operation and maintenance. Please read the safety information below before operating this meter.

Table 1: Safety information

	Important information that must be read before operating this meter.
	Compliant with European CE safety directive

Table 2: Warning information

Warning	The operations marked by this symbol will lead to serious injuries and even deaths.
Caution	It implies that misoperation or neglect in operation will lead to the damaged meter or incorrect measurement results.
Prompt	Operational suggestion or prompt

5. Cautions for Operation

The operator shall obey the cautions below to ensure operational safety and maximum performance.

- ⇒ Before the first operation, check whether the Illuminance meter works properly and confirm that the meter is not damaged during storage and transportation.
- ⇒ Operating environment: temperature: $-10^{\circ}\text{C} \sim 50^{\circ}\text{C}$; humidity $< 80\% \text{RH}$ (without condensation)
- ⇒ Storage environment: temperature: $-10^{\circ}\text{C} \sim 50^{\circ}\text{C}$; humidity $< 70\% \text{RH}$ (without condensation)
- ⇒ To avoid defaults, do not place the illuminance meter in an environment with high temperature or humidity, corrosive or explosive gases, strong electromagnetic pulse or strong vibrating force and dust.
- ⇒ To avoid damage to the meter, do avoid strong mechanical vibration, especially falling accidents, during the handling and operating processes.
- ⇒ The illuminance meter is calibrated, repaired and maintained by professionals alone.
- ⇒ Before each operation, check whether the optical sensor of the illuminance meter is free of abrasion or dust. Make sure that the optical sensor of the illuminance meter is smooth, intact and clean. Do not attempt a measurement with the illuminance meter, if one or multiple functions of the illuminance meter are abnormal or if no preparation is made.
- ⇒ Do not permanently keep the measured value in OL status while operating the illuminance meter.

- ⇒ Prevent the meter from exposure to sunshine. Only in this way can the proper functioning and service life of the meter be guaranteed.
- ⇒ The meter's function may be affected if the meter is subject to very strong electromagnetic field.
- ⇒ Batteries must not be exposed to dampness. Replace batteries if Battery Low indication appears on the LED screen.
- ⇒ The sensitivity of the meter's optical detector will be reduced over time or as a result of operating conditions. To ensure its accuracy, the meter is recommended to be calibrated on a regular basis.
- ⇒ Please properly maintain the original package to facilitate the mailing of this meter (for timely calibration of illuminance).

6. General information

If you is a professional photographer or is a photography lover, and hope to capture the ideal scene, then what you first consider is the illuminance rather than the scene. Although human eyes can estimate the illuminance of light, it still lags behind special photography device in offsetting illuminance. Therefore the photo taken with the aid of human eyes will show a comparatively large departure from the intended effect. Now do you want to possess a device for measuring illuminance? When you purchase a new apartment, you hope your apartment to be geologically advantageous and bright enough in the day. At this moment, do you hope to have an illuminance-measuring device

that is able to detect the illuminance of different corners of the apartment?

The multi-functional illuminance meter is characterized by a user-friendly man-machine interface, operator-friendly keys/buttons, and ability to visually present images. More importantly, the user has various light sources to choose from, and feels free to configure the needed parameters for the light sources.

7. Functional features:

- ① Automatic and manual switchover of measuring range;
- ② Max/Min value query;
- ③ Data hold;
- ④ Peak value measurement;
- ⑤ Relative value measurement;
- ⑥ Zero-scale calibration;
- ⑦ 3 1/2 digit LCD display, with analogue bar graph
- ⑧ Unit conversion Fc/Lux
- ⑨ "OL" appears to remind the value of outrange;
- ⑩ Battery Low indication;
- ⑪ Auto power off (this function will occur if there is no pressing on the key within 10 minutes)
- ⑫ Structural compactness, durability, and portability

8. Description of the meter's panel

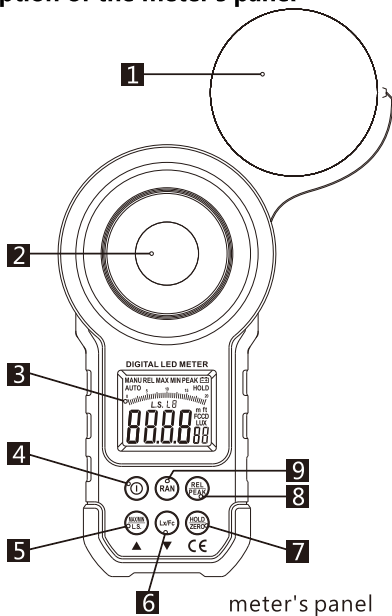

1 Optical sensor cover

2 Optical sensor

3 LCD screen

4 Power source/key tone button;

On/off power: a short press to power on, a long (1 second) press to power off;

On/off key tone: work mode, short press on Turn On/Off
Key tone

5 Max/Min value query mode button

6 Unit conversion button:

Lux/Footcandle(Lux/Fc)

7 Data hold/Zero-scale calibration button :

Data hold: a short press to enter/exit data hold mode

Zero-scale calibration: a long (1 second) press to execute zero-scale calibration function

8 Relative value/peak value measurement button :

Relative value measurement: a short press to enter/exit relative measurement mode

Peak value measurement: a long (1 second) press to enter/exit peak measurement mode

9 Manual switchover of measuring range :

Give a short press to enter the status of manual measurement and with another press, jump to the next measuring range.

Give a long press for over 1 second to exit the manual range mode.

9. LCD interface

- 1 Manual switchover mode prompt
- 2 Relative value measurement mode prompt
- 3 Maximum value query mode prompt
- 4 Minimum value query mode prompt
- 5 Peak value measurement mode prompt
- 6 Battery Low prompt
- 7 Data hold mode prompt
- 8 Light source set value symbol
- 9 Fc unit symbol
- 10 Lux unit symbol
- 11 Auto measurement mode prompt
- 12 Analogue bar graph mode for displaying the current measured value
- 13 Light source selection prompt
- 14 Digital display mode for showing current measured value

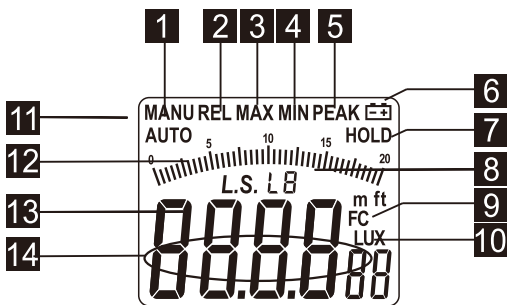

10. Measurement method

10.1 Pre-measurement considerations

Warning



- ◆ Do not attempt to operate this meter in an environment with explosive gas substances, combustible vapor substances and full of dust!
- ◆ Do not attempt a measurement when the meter is in a place of high temperature and humidity.
- ◆ Do not attempt to operate this meter when the meter is in an environment featuring a high level of infrared or ultraviolet rays.

Prompts



- ◆ The meter's light sensor is designed by the curve of the sensitivity of human eyes to light, with the spectral range of 320~730nm. If measurement is taken within the infrared range, the data will show greater deviations.
- ◆ Light sensor is calibrated at the color temperature of 2854 ° k color temperature and in accordance with CIE requirements on standard incandescent lamps. The reading provided may vary, depending on the spectra of other types of lamps.
- ◆ The reference level for a light source test is at the front end of the sphere illuminated by light.
- ◆ Don't attempt a measurement unless the optical detector has been exposed to light for 2 minutes.
- ◆ The operator shall prevent the optical detector from being affected by his silhouette and other factors.

10.2 Working principle

Concepts of illumination scales

1 Lux (lx) refers to the illuminance of a lamp (equivalent to a candle in light intensity and 1m away from one 1-s.q.m surface) on the aforesaid surface.

1 Fc (Fc) refers to the illuminance of a lamp (equivalent to a candle in light intensity and 1m away from one 1-s.q.foot surface) on the aforesaid surface.

Illuminance scale unit conversion:

1 foot-candle = 10.764 Lux;

1 Lux = 0.09290 foot candle.

10.3 Typical operations

In the operations below, you shall stand in a light source and take off the protective cover of the sensor of multi-function illuminance meter, and make it perpendicular to the light source, as shown in the figure.

Give a short press on the key **4** to enable the device and then the LCD will show (for approximately 5 seconds). At the same time, the beeper sounds twice. The word "AUTO" appears in the middle of the LCD screen and the meter enters the mode of auto measurement. Give a short press on the key measuring range manual switchover **9**, and the word "MANU" will appear at the upper left of LCD screen. This means that the meter has entered the mode for manually switching measuring range. In this mode, each short press of the key will mean the switchover cycle 20.00Lux—>200.0Lux—>2000Lux—>20000Lux—>200000Lux (or 20.00Fc—>200.0 Fc—>2000 Fc—>20000 Fc). Give a long (1 second) press and the word "MANU" will appear at the upper left

of the LCD screen. At this moment, exit the MANU mode to enter the "AUTO" mode. Give a short press on the composite key Relative Value/Peak Value Measurement **8** and the word "REL" will appear at the upper left of the LCD screen. This means the meter has entered the relative value measurement mode. With another short press on the same key, the meter will exit the relative value measurement mode, and the word "REL" at the upper left of the screen will disappear and the meter returns to its original measurement mode. Give a long (1 second) press on Relative Value/Peak Value Measurement Key **8**, and the meter will enter the peak value measurement mode and the words "PEAK" and "MANU" appear at the upper right of LCD screen. With another long (1 second) press on the key, the word "Peak" at the upper right of the screen will disappear and the word "AUTO" will appear in the middle of the screen. At this moment, the meter enters the AUTO Measurement Mode. **8** Give a short press on the key Max/Min value Query **5**, the word "MAX" will appear at the upper front of the LCD screen. At this moment, the meter enters the Max/Min value Query Mode. Within this mode, each short press on the aforesaid key, the meter will enter the switchover cycle of MAX<—>MIN. Give a long press (1 second) on the key MAX/MIN, the word "MAX/MIN" at the upper front of the screen will disappear and the meter will exit Max/Min value Query Mode. Give a short press on the composite key Hold/Zero Calibration **7**, the word "HOLD" will appear at the upper left of LCD screen. At this moment, the meter enters the Hold mode. With another short press on the key, the word "HOLD" at the upper left of the screen will disappear and the meter will exit the Hold Mode. **In any mode, cover the sensor and give a long (1 second) press on the key**

Hold/Zero Calibration ⑦. Then the word "ADJ" appears on the LCD screen and the meter enters the zero-scale calibration mode. Several seconds later, the word "ADJ" will disappear and the meter will exit zero-scale calibration mode and return to AUTO measurement mode.



Prompts

1. The reference level for a light source test is at the front end of the sphere illuminated by light.
2. In various measurement modes, the analog bar in the middle of the LCD screen will vary in accordance with the digital changes shown on digital tubes.
3. Give a short press on "Hold/Zero" to lock the current data when capturing the reading.
4. Be sure to protect optical sensor with its protective cover before attempting a zero-scale calibration.
5. When the test is completed, protect optical filter and sensor by remounting the protective cover for the sensor.



11. Specific applications

11.1 Measuring range manual switchover mode

1. Give a short press on the key RAN (the key for manually

switching measuring range) to enter the aforesaid mode. At this moment, the word "MANU" will appear at the upper left of the LCD screen (as shown in the figure below);

- In the measuring range manual switchover mode, give a short press on the key RAN and enter the switchover cycle of 20.00Lux—>200.0Lux—>2000Lux—>20000Lux—>200000Lux (or 20.00Fc—>200.0 Fc—>2000 Fc—>20000 Fc);
- Give a long press (1 second) on the key RAN and the word "MANU" at the upper left of the LCD screen will disappear and the word "AUTO" will appear in the middle of the screen. Then the meter will exit the mode for measuring range manual switchover and return to the mode for measuring range manual switchover;

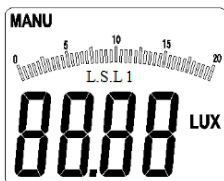
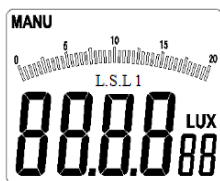
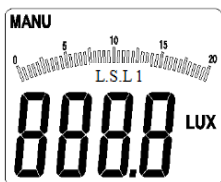

Figure 3-1-1



20.00Lux interface



200.0Lux interface

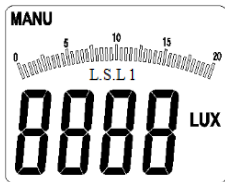

2000Lux interface

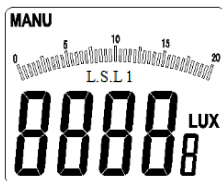

20000Lux interface

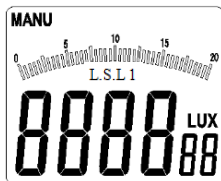

200000Lux

Prompts



- ◆ A short press on the key RAN is valid for peak value/relative value measurement mode and Max/Min Value Query mode.
- ◆ In the relative value measurement mode and max/min value measurement mode, give a long (1 second) press on the key and the meter will return to the measuring range manual switchover mode.
- ◆ In the peak value measurement mode, data hold mode and zero-scale calibration mode, a long press on the key RAN will be invalid.
- ◆ In this mode, when the measured value is over the current measuring range, the word "OL" will appear on the LCD screen to remind the operator of such outrange. At this moment, the operator shall switch to another measuring range.

11.2 Relative value/peak value measurement mode

1. Give a short press on the key REL/PEAK (the composite key for relative value/peak value measurement), the word "REL" will appear at the upper left of the LCD screen (as shown in Fig. 3-1-2A) and the meter will enter the mode for relative value measurement;

2. Give another short press on the key REL/PEAK to exit the mode for relative value measurement. At his moment, the word "REL" at the upper left of the LCD screen will disappear and the meter will return to the previous measurement mode;
3. Give a long (1 second) press on the key "REL/PEAK" to enter the peak value measurement mode. Then the word "PEAK" appears on the upper right of the screen while the word "MENU" appears on the upper left of the LCD screen (as shown in Fig.3-1-2B);
4. Give another long press (1 second) on the key and the word "PEAK" at the upper right of the LCD screen will disappear and the word "AUTO" appears in the middle of the screen. At this moment, the meter returns to the auto measurement mode (as shown in Fig.3-1-2C).

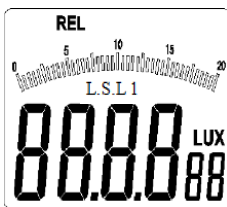

Fig. 3-1-2A

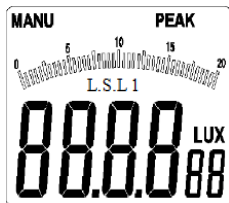

Fig. 3-1-2B

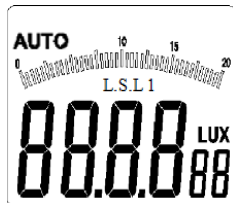

Fig. 3-1-2C

Prompts



- ◆ The Key "REL/PEAK" is valid in auto measurement mode, peak value measurement mode, max/min value query mode, and data hold mode.
- ◆ Give a long (1 second) press on the key "REL/PEAK" in the non-zero calibration mode and enter peak value measurement mode.

11.3 Max/min value query mode

1. Give a short press on the key "MAX/MIN/LS" and the word "MAX" appears on the upper front of the LCD screen (as shown in Fig.3-1-3). At this moment, the meter enters the max/min value query mode;
2. In max/min value query mode, each short press on Key "Max/Min" will realize the switchover cycle of MAX \longleftrightarrow MIN;
3. Give a long (1 second) press on the key "MAX/MIN" and the word "Max/Min" at the upper front of the LCD screen disappears. At this moment, the meter will exit the max/min value query mode.

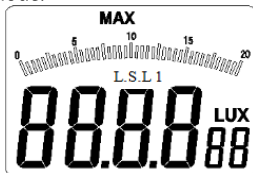

Fig. 3-1-3

Prompts



A short press on the key "Max/Min" is valid in non-zero calibration mode. It enables the function of max/min value;

11.4 Data hold/zero calibration mode

1. Give a short press on the key "HOLD/ZERO" and the word "HOLD" appears on the upper left of the LCD screen (as shown in Fig.3-1-4A). At this moment, the meter will enter data hold mode;
2. Give another short press on the aforesaid key and the word "HOLD" at the upper left of the LCD screen will disappear. At this moment, the meter will exit data hold mode;
3. Use the protective cover to cover the optical sensor and give a long (1 second) press on the key "HOLD/ZERO" . Then the word "ADJ" appears on the LCD screen (as shown in Fig.3-1-4B) to enter the zero calibration mode. Several seconds later, the word "ADJ" on the screen will disappear and the meter will automatically exit zero calibration mode and return to auto measurement mode.

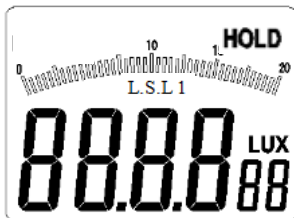

Fig. 3-1-4A

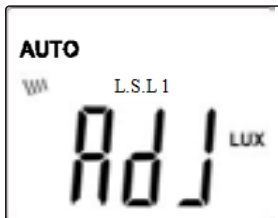

Fig.3-1-4B

 Caution



Be sure to protect optical sensor with its protective cover before attempting a zero-scale calibration.

 Prompts

- ◆ A short press on the key "HOLD/ZERO" is valid in the non-zero calibration mode. Give the short press on the aforesaid key and the meter will enter data hold mode.
- ◆ Zero-scale calibration is valid in any mode.

11.5 Light source selection mode

1. Light source selecting

Give a long (1 second) press on the key "MAX/MIN/L.S." and the letter "N" in the word "L.S.LN" on the LCD screen will jump to indicate that the meter has entered the light source selection mode. At this moment, give a short press on the key "MAX/MIN/L.S." or "Lx/Fc" and the light source will vary from L0 to L9; Press the key "HOLD/ZERO" for confirmation and enter the normal measuring mode. Then the measurement will start.

2. Light source parameter Setting

2.1 Give a long (1 second) press on the key "MAX/MIN/L.S." and the letter "N" in the word "L.S.LN" on the LCD screen will jump to indicate that the meter has entered

2.2 Light source selection mode ,

At this moment , give a short press on the key "MAX/MIN/L.S" or "Lx/Fc" key , and the light source will vary from L0 to L9; Select the light source code L0-L9 needed to be set

2.3 Give a short press on the key "RAN", then the letter "N" will stop jumping and parameters jump to indicate that the

meter has entered the parameter configuration mode. At this moment, give a short press on the key "MAX/MIN/L.S." or "Lx/Fc" to configure parameters;

2.4 Give another short press on the key "RAN" to enter the light source selection mode. At this moment, the letter "N" jumps and parameters stop jumping. Then switch back and forth sequentially.

2.5 Give a long (1 second) press on the key "MAX/MIN/L.S." to save the configured parameters of light source and enter the mode for normal measurement.

L0—> standard light source A : 1.000

L1—>LED white light : 0.990

L2—>LED red light : 0.516

L3—>LED amber (yellow) right : 0.815

L4—>LED green light : 1.216

L5—>LED blue light : 1.475

L6—>LED purple light : 1.148

L7--L9-> default standard light source A: 1.000

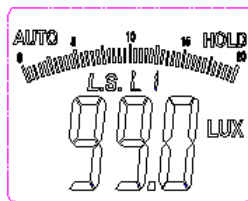
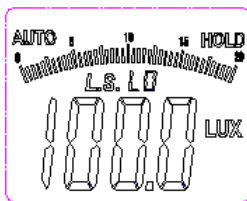

12. Other functions available

12.1 Mute

Give a short press on the composite button "Power/Key Tone" (4) to enable or disable the key tone.

12.2 Auto shutdown

The meter will be automatically shut down if there is no operations within 10 minutes.

13 Technical data

- Temperature range:
Operating temperature: -10~50 OC, maximum 80% relative humidity (no condensation).
Storage temperature: -10~50 OC, maximum 80% relative humidity (no condensation) (Remove battery).
- Sampling rate: ≥ 2 revolutions/second.
- Display screen: 3½ digits, max reading: 1999, with analogue bar graph;
- Sensor: silicon photodiode
- Spectral range: 320 ~ 730nm
- Measuring range: 20, 200, 2000, 20000, and 200000 Lux
20, 200, 2000, 20000 FC
- Operating environment: for indoor use
- Altitude: 2000m at most
- Cell service life: approximately 200 hrs
- Power source: 1×9 V, IEC 6LR61
- Dimensions (height x width x depth): 170 mm x 89 mm x 43mm

- Weight: approximately 177g, exclusive of battery
- Precision: $\pm 3\%$ (calibrated in accordance with CIE requirements on standard incandescent lamp and at 2854K)
 $\pm 6\%$ other visible light source

Deviation characteristics of cosine angle	
Cosine angle	Deviation
30°	$\pm 2\%$
60°	$\pm 6\%$

Note: the cosine angles calibrated in accordance with JIS C 1609:1993 and CNS 5119 general specifications.

14. Features of luminous sensitivity:

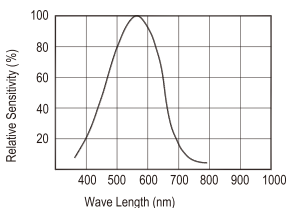

14. Repair & Maintenance

14.1 Repair



If any faults seem to exist in operating process, the operator shall try to identify sources of such faults by taking the steps below:

- ◆ Check batteries. Replace batteries immediately when the



symbol “” appears on the LCD screen.

- ◆ Read operation instructions to check whether operational steps are incorrect.
- ◆ Before mailing the damaged illuminance meter, please remove batteries, describe in detail the aforesaid faults, and pack the meter in a way that can prevent it from being damaged during transportation. Our company will not be responsible for any damages that arise in the transportation.
- ◆ The meter must be repaired and maintained by the specialists assigned by the service centers authorized by our company or any other specialists with sufficient qualifications.

14.2 Cleaning

First clean the detector with a soft cloth dampened with clear water or a mild detergent and then clean the detector with a piece of dry cloth.



- ◆ Please make sure that the meter has been powered off before cleaning starts.
- ◆ Don't attempt a cleaning work with such materials as benzene, alcohol, acetone, ether, alkone, diluent and petrol, because the aforesaid materials will result in deformation or discoloring of the meter.
- ◆ Do not attempt to resume the operation unless the meter has been cleaned and dried entirely.

14.3 Battery replacement

Replace batteries immediately after battery symbol flickers on LCD screen^⑨. Batteries are replaced by the steps below:

- ① Power off the meter;
- ② Unscrew the bolts on the meter's back and take off the battery cover;
- ③ Remove the exhausted battery;
- ④ Mount new batteries in the way that polarities are kept correct.

Caution



- ◆ Do not attempt a battery replacement unless the meter has been disenabled.
- ◆ Only use the batteries clearly specified in technical specification.
- ◆ Do not attempt to remove batteries if such batteries are left idle for a long period of time.
- ◆ The removed batteries must be disposed of in accordance with the currently applicable regulations on battery recycling, reuse and disposal.

14.4 Calibration interval

To ensure its measurement accuracy, the meter must be calibrated regularly by qualified technicians. We recommend that the meter shall be calibrated annually. The meter must be calibrated at a shorter interval, if it is used constantly or in adverse conditions. The meter can be calibrated at a longer interval if it is used infrequently.

15. Reference illuminance values for various locations

The F_c illuminance can be figured out by dividing the Lux illuminance by 10.76.

Schools:

Illuminance (Lux)	Location
1500~300	mechanical drawing labs, sewing classrooms and computer rooms
750~200	Classrooms, laboratories, training workshops, research rooms, library reading rooms, stack rooms, offices, faculty lounges, meeting rooms, health centers, dining rooms, kitchens, diet preparation rooms, radio broadcasting rooms, printing rooms, switchboard rooms, guardrooms, and indoor stadiums
300~150	Large classrooms, auditoriums, storage rooms, lounges, and stairways
150~75	Corridors, elevator lobbies, toilets, duty rooms, overpasses, and outdoor stadiums
75~30	Warehouse, garage and safe ladder

Office:

Illuminance(Lux)	Location
2000~1500	Design room, and office
1500~750	Hall routes(in daytime) 、 business rooms, drawing rooms, check-in rooms, and typing rooms

750~300	Calculator room, conference room, printing room, switchboard room, control room, entertainment room, recreation room and restaurant
300~150	Stack rooms, entertainment rooms, restaurants, classrooms, guard rooms, elevator (lobbies),bathrooms and toilets
150~75	Tea rooms, changing rooms, warehouses, and duty rooms(entrance)
75~30	Fire escape stair

Factory

Illuminance (Lux)	Location
3000~1500	Ultra precision work, design, drawing, and precision inspection
1500~750	Design room, analysis, assembly line, and coating
750~300	Packaging rooms, measurement rooms, surface treatment workshops, and warehouses
300~150	Dyeing workshops, casting workshops, and electrical workshops
150~75	Entrances and exits, corridors, channels, stairways, dressing rooms, toilets, and warehouses with operation yards

75~30	Fire escape stairways, warehouses, outdoor power consumers(for goods handling and inventory movement)
-------	---

Hospital

Illuminance (Lux)	Location
10000~5000	Visual function inspection rooms(Ophthalmology room)
1500~750	Operating room
750~300	Consulting rooms, treatment rooms, pharmacy rooms, dispensary rooms, pharmaceutical labs, autopsy rooms, pathological bacteriology rooms, first-aid rooms, delivery rooms, superintendent offices, administration offices, nurse offices and meeting rooms
300~150	Wards, medicine storage rooms, reading, dressing changing and plaster dressing at wards, infant rooms, recording rooms, waiting rooms, consulting room, and clinic corridors
150~75	Changing rooms, treatment rooms-ray rooms, corridors outside wards, medicine storage rooms, sterilization rooms, wards, staircases, and endoscopy rooms
75~30	Animals rooms, dark rooms(photography) and emergency staircases

Hair parlor

Illuminance (Lux)	Location
1500~750	hair cutting, perm, hair dyeing, and makeup
750~300	Shaving, hair washing, reception desk and dressing
300~150	In-shop toilets
150~75	Corridors and stairways

Hotels, restaurants, and casinos

Illuminance (Lux)	Location
1500~750	Counter
750~300	Entrances, banquet halls, affairs rooms, parking lots, and kitchens
300~150	Restaurants, toilets, and Japanese-style rooms
150~75	Entertainment rooms, corridors, staircases, guest rooms, bathrooms, key lighting for yards, and changing rooms
75~30	Fire escape stair

Shops and department stores

Illuminance (Lux)	Location
3000~750	Indoor furnishings, decorative window, demonstration venue for performance, checkout counters and packing table
750~300	Elevator lobbies and escalators
300~150	Negotiation rooms, dressing rooms, toilets, staircases, and aisles
150~75	General lighting for lounges and shops

Household:

Illuminance (Lux)	Location
2000~750	Crafts and sewing
1000~500	Writing and working
750~300	Reading, makeup, kitchen table, conditioning, and telephone
300~150	Kitchen sinks, entertainment rooms, drawing rooms, reunion, and mirror at the entrance (interior)
150~70	Wardrobe, bedroom, toilet, staircase and corridor
75~30	Door plate, mailbox doorbell button, and balcony