

Instruction manual

Field Network Devices

ARIO Series

MOO-ARIOS-V1.2-2103US

Thank you for purchasing an Autonics product.
This user manual contains information about the product and its proper use,
and should be kept in a place where it will be easy to access.

Preface

Thank you for purchasing Autonics product.





Please familiarize yourself with the information contained **in the Safety Considerations section** before using this product.

This user manual contains information about the product and its proper use, and should be kept in a place where it will be easy to access.

Instruction Manual Guide

- Please familiarize yourself with the information in this manual before using the product.
- This manual provides detailed information on the product's features.
- It does not offer any guarantee concerning matters beyond the scope of this manual.
- This manual may not be edited or reproduced in either part or whole without permission.
- This manual is not provided as part of the product package.
Please visit our website (www.autonics.com) to download a copy.
- The manual's content may vary depending on changes to the product's software and other unforeseen developments within Autonics, and is subject to change without prior notice. Upgrade notice is provided through our homepage.
- We contrived to describe this manual more easily and correctly. However, if there are any corrections or questions, please notify us these on our website

Instruction Manual Symbols

Symbol	Description
 Note	Supplementary information for a particular feature.
 Warning	Failure to follow instructions can result in serious injury or death.
 Caution	Failure to follow instructions can lead to a minor injury or product damage.
 Ex.	An example of the concerned feature's use.
※1	Annotation mark.

Safety Considerations

- Please observe all safety considerations for safe and proper product operation to avoid hazards.
- Safety considerations consist of 'warning' and 'caution'. The following symbols represent caution due to particular circumstances in which hazards may occur.

	Warning	Warning	Failure to follow instructions can result in serious injury or death.
---	----------------	----------------	---

	Caution	Caution	Failure to follow instructions can lead to a minor injury or product damage.
---	----------------	----------------	--

Warning

- Fail-safe device must be installed when using the unit with machinery that may cause serious injury or substantial economic loss. (e.g. nuclear power control, medical equipment, ships, vehicles, railways, aircraft, combustion apparatus, safety equipment, crime/disaster prevention devices, etc.)
Failure to follow this instruction may result in personal injury, economic loss or fire.
- Do not use the unit in the place where flammable/explosive/corrosive gas, high humidity, direct sunlight, radiant heat, vibration, impact, or salinity may be present.
Failure to follow this instruction may result in explosion or fire.
- Do not disassemble or modify the unit.
Failure to follow this instruction may result in fire.
- Do not connect, repair, or inspect the unit while connected to a power source.
Failure to follow this instruction may result in fire.
- Check 'Connections' before wiring.
Failure to follow this instruction may result in fire.

Caution

- Use the unit within the rated specifications.
Failure to follow this instruction may result in fire or shortening the life cycle of the product.
- Use a dry cloth to clean the unit, and do not use water or organic solvent.
Failure to follow this instruction may result in fire or electric shock.
- When connecting the power input and I/O wiring, use AWG 22~16 cable.
- After checking the connecting and removing the wire, use the crimp terminal.
- Failure to follow this instruction may result in fire or malfunction due to contact failure.
- Keep the product away from metal chip, dust, and wire residue which flow into the unit.
Failure to follow this instruction may result in fire or product damage.
- Do not cut off power or disconnect connectors (or terminals) while operating the unit.
Failure to follow this instruction may result in fire or product damage.

The specifications and dimensions of this manual are subject to change without any notice

Caution during Use

- Follow instructions in 'Caution during Use'. Otherwise, it may cause unexpected accidents.
- ABUS power and I/O power should be insulated by the individually insulated power device.
- Power supply should be insulated and limited voltage/current or Class 2, SELV power supply device.
- Use the rated standard cables and connectors. Do not apply excessive power when connecting or disconnecting the connectors of the product.
- Keep away from high voltage lines or power lines to prevent inductive noise.
- In case installing power line and input signal line closely, use line filter or varistor at power line and shielded wire at input signal line. For the stable operation, use shield wire and ferrite core, when wiring communication wire, power wire, or signal wire.
- Do not use near the equipment which generates strong magnetic force or high frequency noise.
- Do not touch the module communication connector part of the base.
- Do not connect or remove the base while connected to a power source.
- For removing the terminal, body or base, do not operate units for a long time without it.
- This unit may be used in the following environments.
 - ① Indoors
 - ② Altitude max. 2,000m
 - ③ Pollution degree 2
 - ④ Installation category II

Table of Contents

Preface	iii
Instruction Manual Guide	iv
Instruction Manual Symbols	v
Safety Considerations	vi
Caution during Use	vii
Table of Contents	viii
1 Reference manuals	10
2 Overview	11
3 ARIO system	12
3.1 Unit configuration	12
3.2 System power supply and distribution	13
3.3 Insulation	13
4 Installation	14
4.1 Environmental condition	14
4.2 Installation positions	15
4.3 Unit configuration	15
4.4 DIN rail mounting & removing	15
5 Wiring	19
5.1 Cautions for communication cable	19
5.2 Install ferrite core	20
5.3 Connector specifications	20
5.4 Wire ferrule specifications	21
5.5 Connecting & removing	21
6 Earthing and shielding	22
6.1 Earthing	22
6.2 Shield connecting system	23
6.3 Possible shielding connection	23
7 Maintenance	24
7.1 Component part of the module	24
7.2 Body-Terminal disassembly & assembly	25
7.3 Base-Body disassembly & assembly	25
7.4 DIN rail-Base disassembly & assembly	25

8 Operation26

8.1 Workflow.....26

8.2 Monitoring.....27

9 DAQMaster functions.....28

10 Appendix29

10.1 Glossary29

1 Reference manuals

Refer to the following manuals to use the ARIO system stably and safely.

Instruction manual	It describes an overview of ARIO system, installation environment, and maintenance, etc.
Coupler manual	It describes the overview of each communication, specifications, dimensions, memory map and troubleshooting.
Module manual	It describes the dimensions, specifications, and connections of each module.
DAQMaster user manual	You can use module setting, real-time control of input/output signal, and monitoring/diagnosis function (except ARIO-C-PN and ARIO-C-PB) via DAQMaster. Also, the virtual mode and recommended sorting provides an arrangement the coupler and modules.

2 Overview

- Support I/O based on the industrial Ethernet/Fieldbus serial communication for Smart Factory
- Sequential multiple I/O distribution control via PLC, Industrial PC, etc
- Coupler: Supports various communications. (EtherCAT, CC-Link, ProfiNet, Profibus, Ethernet/IP, DeviceNet, Modbus TCP compatible, Modbus RTU compatible)
- Module: Various input/output modules, power modules:
BUS and I/O power, digital input/output (4/8CH), analog input/output (2/4CH), TC/RTD input (4CH)
Up to 64 modules can be extended (depending on communication and user configuration)
- Hot-swap function: The settings can be restored automatically by replacing terminal and body during operation, and easy maintenance
- Push-in connection: Easy wire connection without tools, helping to reduce the workload
- Improved user convenience with DAQMaster, a device integration management program
 - Module settings, real-time control of input/output signal, monitoring, and diagnosis function
 - Product selection and placement through virtual mode, offering recommended sorting

3 ARIO system

3.1 Unit configuration

1. Coupler (ARIO - C)

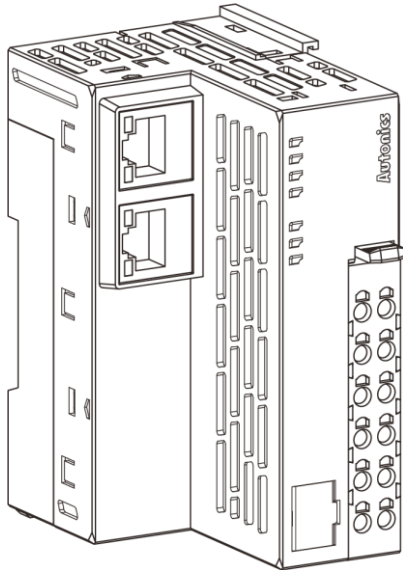

Main features

- Field network communication (Slave) as insulated
- Manages memory map and sets modules
- 24VDC coupler power as external non-insulated

2. Module (ARIO - S, ARIO - P)

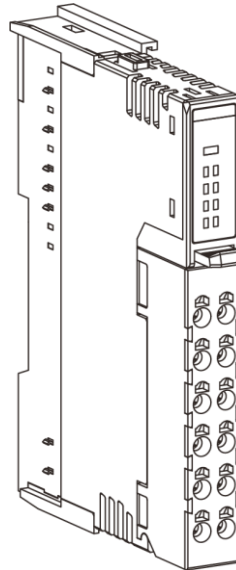

Main features

- I/O module: Digital and Analog signals
- Power module: Providing BUS and I/O power
- Special module: Temperature/Counter/Pulse input and more
- Hot-swap available
- ※ The base of I/O and power module has a different shape. Beware of that when you install the product or the Hot-swap condition.

3. End module

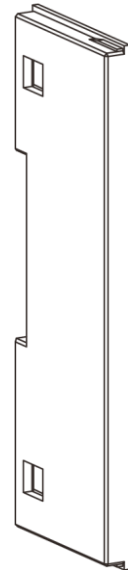

Main features

- The last module of system
- Prevents base from the system exposure

■ End plate (sold separately)

Main features: Fixing the unit mounted on the DIN rail (recommended installation height: ≤ 15 mm)

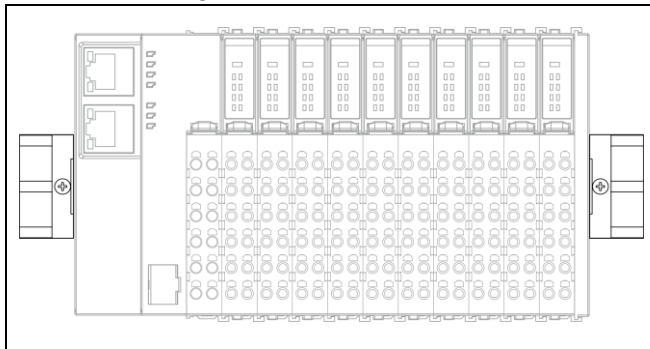

3.2 System power supply and distribution

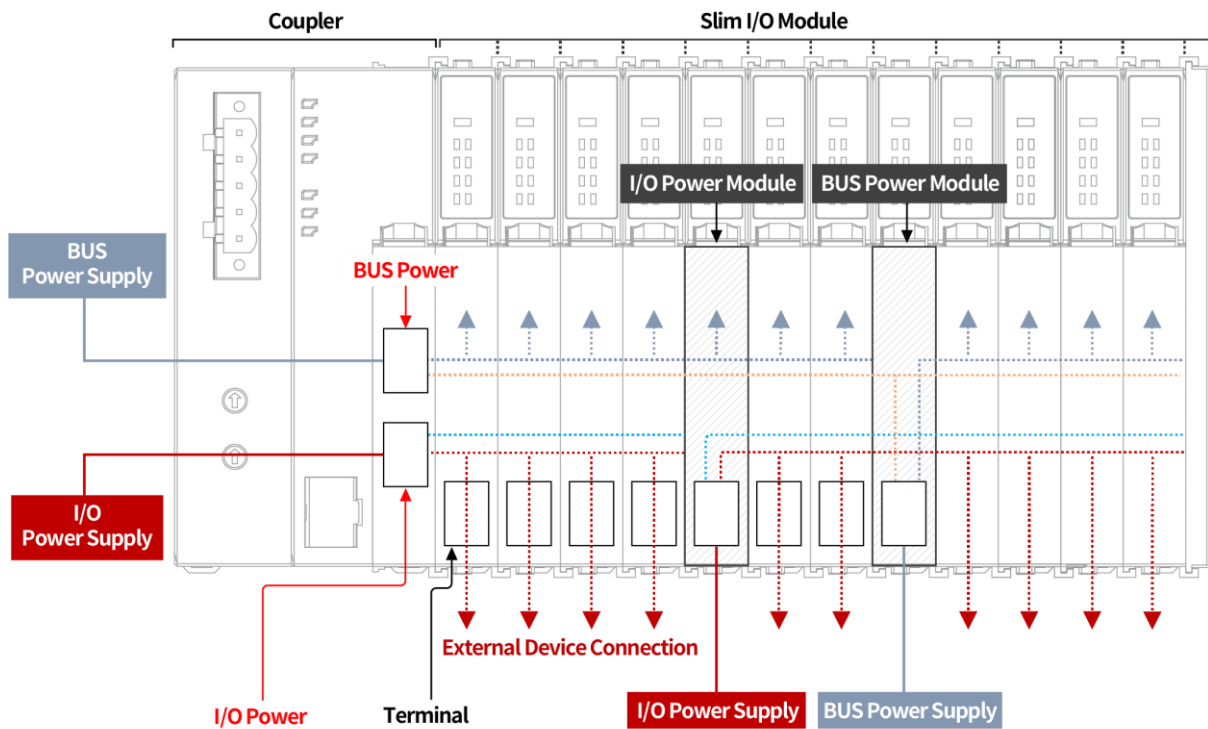

Name	Terminal input (external)	Base distribution (internal, ABUS)		
	Supply Power	Bypass Power	Cut-Off Power	Power Type
Coupler	ABUS Power, I/O Power	do not care	ABUS Power, I/O Power	VDC
Power module (BUS power)	ABUS Power	I/O Power	ABUS Power	VDC
Power module (I/O power)	I/O Power	ABUS Power	I/O Power	VDC, VAC

※ The affecting power range when removing the body and terminal of the module.

3.3 Insulation

Insulation	Circuit	Description
Insulated	Inner and external communication circuits	Communication terminal for Field network – Inner control circuit
	External ABUS power circuit – External Field power circuit	Between power circuits with external input
Non-insulated	External ABUS power circuit – Inner control circuit	ABUS power supply with external input – (internal) control circuit
	External ABUS power circuit – External control circuit	I/O power supply with external input – (external) control circuit
	Inner BUS power circuit – Inner control circuit	(internal) BUS power supply – (internal) control circuit

4 Installation



Caution

- The functions that the product provides can be limited depending on the installation environment. Be sure to read each manual carefully before you start the installation.
- There is possible to generate heat while the product is operating. It doesn't have any impact on the operation if a particular case does not occur.

4.1 Environmental condition

- Be sure to follow the climatic environmental conditions listed on the specifications from the coupler and module user manual.
- Install the temperature input module in a place out of the direct wind.
- Consider the installation positions and design for sufficient ventilation. It has to pull the heat from the lower part to the upper part of the product. Install an air exhaust fan in the top.

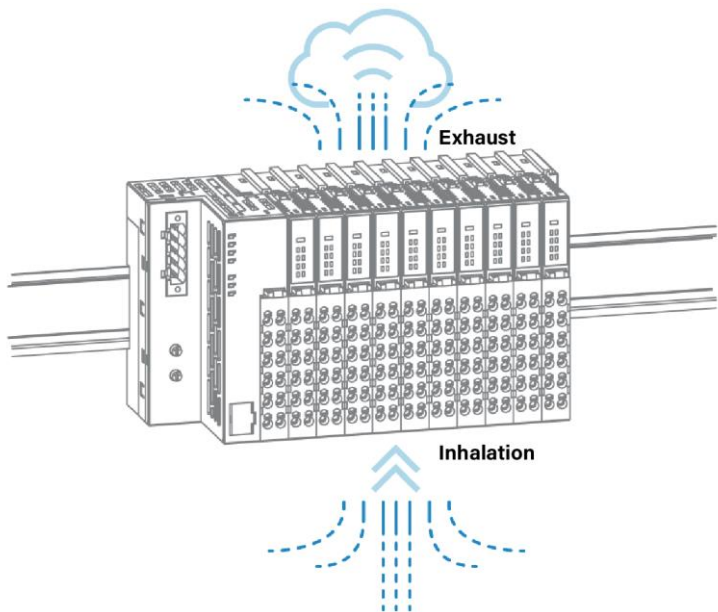

- To minimize the interference and impact of products, wire, and peripheral devices, be sure to install the ARIO to meet installation distance.

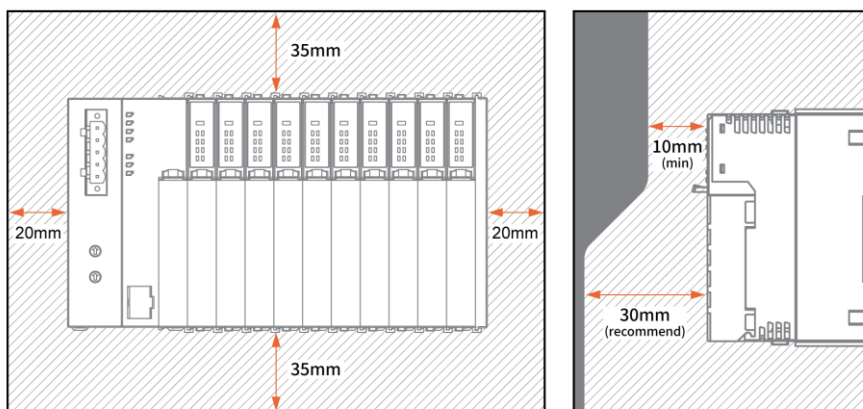

4.2 Installation positions

- The horizontal, vertical, top, and bottom positions are available.
- We recommend that install the temperature input module to be the top or bottom position.

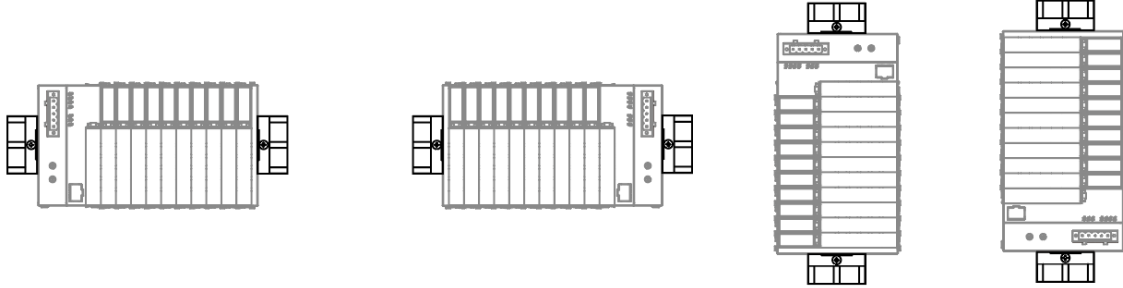

4.3 Unit configuration

- You can use the virtual mode via DAQMaster for the connection method.
- Follow the regulations below to configure the modules.
 - The number of connected modules: up to 32 or 64 modules
 - The Length of connection: 768 mm (include the power module and except the coupler/end modules)
 - 8 digital I/O modules and 4 analog/special modules can be connected to ARIO-P-B or ARIO-P-F1.
 - Do not connect the temperature input module at the left and right side of the power module.
 - If you have difficulty with this configuration, place the I/O module (word type) first. And then put a bit or 1-byte type module next to it.

4.4 DIN rail mounting & removing

(1) Preparations for mounting

Prepare a non-conductive flat head (-) screw driver (tip width: ≤ 3 mm) and the layout of the unit with an intended configuration.

Unit: mm, install the DIN rail that meets the sizes below.

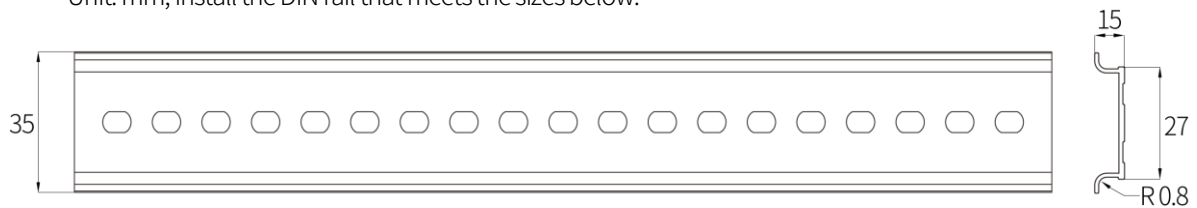

(2) Mounting

Inset the products from left to right, in order from the coupler to the module.

When inserting the module, be sure to engage the tongue and groove joints of adjacent modules.

The position of the DIN rail fixing device (Rail Lock) is like the figure below.

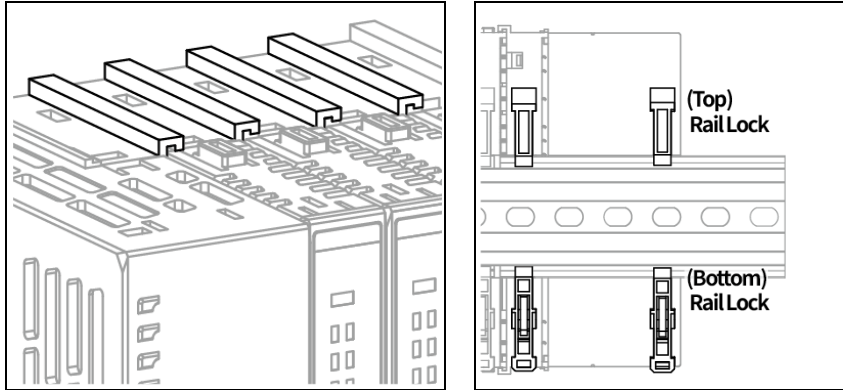

1st Hook the prepared screwdriver to the bottom Rail Lock of the coupler and pull it down.

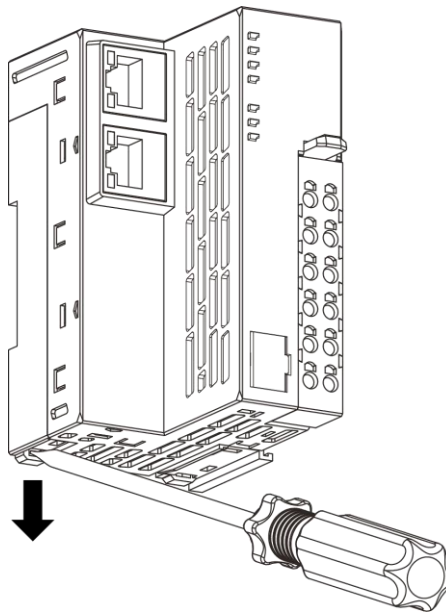

2nd Place the top Rail Lock of the coupler on the DIN rail.

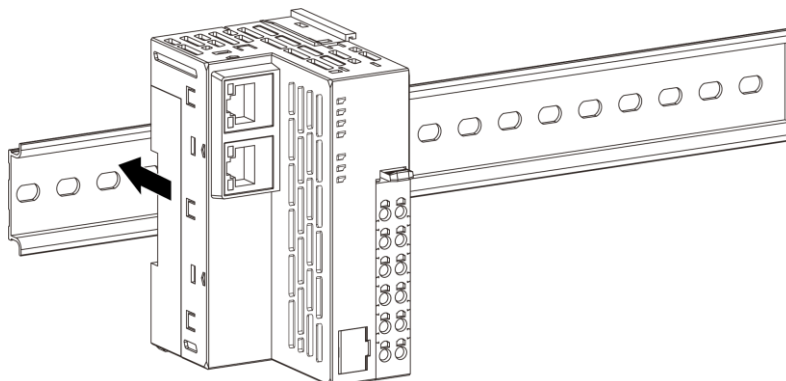

- 3rd** Place the module on the DIN rail in the same way as the coupler and slide it to the direction of the coupler.

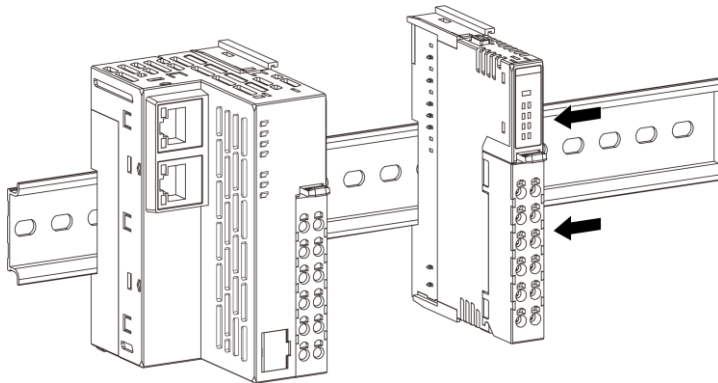

- 4th** Mount the end module on the side of the last module.

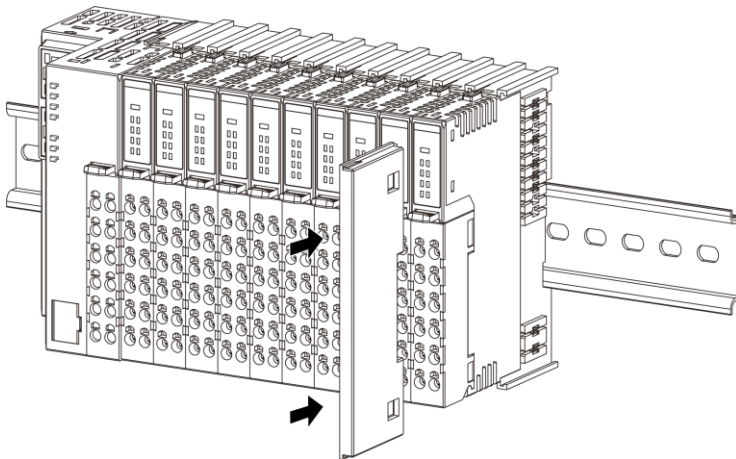

- 5th** Push up all Rail Locks using the screwdriver to mount the unit.
※ You can attach the End plate (sold separately) to the unit's left and right side to fix it firmly.

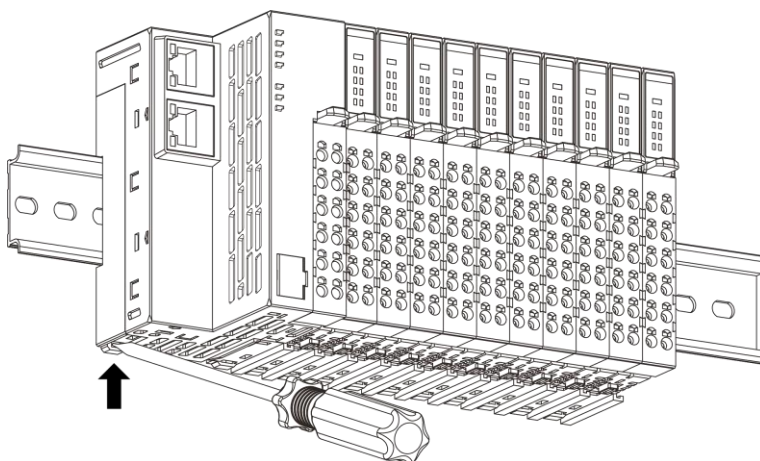

(3) Removing

If another module is connected at the right side of the module to be removed, the base may not be removed.

ARIO series must be removed as the reverse of installation order:

End plate → End module → Module → Coupler.

1st Hook the screwdriver to the Rail Lock and pull it down.

2nd Lift the product and remove it from the DIN rail.

5 Wiring

 Caution	<ul style="list-style-type: none"> • Use the UL and KC certified or each field network association certified cables. • Use the copper-conductor wire with the temperature class 60°C. • Do not connect or disconnect cables from the terminal while the product is operating. • Beware of the safety accidents when the hot-swap is activated. It may result in serious personal injury and economic loss. • For wiring, use only tools made of non-conductive materials except for pinhole terminals. Depending on the product's connection and operating conditions, it may result in serious personal injury and economic loss. • Carefully organize and arrange the cables to minimize stress.
--	--

5.1 Cautions for communication cable

Requirements	Description
Use standardized products	Use accessories, such as connectors and cables, that are certified by the field network associations.
Comply with node space (The length of communication cable)	Install the cables in accordance with the minimum and maximum distances in each transfer rate allowed by the field network associations. Observe the minimum cable connection intervals defined by the field network associations. (It normally has 1m apart.)
Do not T-shaped branch	Do not use T-shaped branch or cable extension, which may cause communication noise. In case of a daisy chain, incorrect coupling can cause line breaks and make noise.
Do not annular arrangement	Make the cable arrangement in smooth way. (In case of 1m cable, the first 1/4 point and the last 1/4 point should contact with each other.) Do not arrange the cables in the form of annular, 8 type and 0 type.
Detach segment	Separate segments by function. Separate the control area of the product to limit the propagation when problems occur. When connecting the maximum node of a single trunk defined by the field network associations, separate the segment (16 nodes or 32 nodes units, different from each field network) by considering the noise on communication lines. Be sure to install one repeater per segment in the serial communication.
Use a hub	It is recommended to use a hub or switch hub (available for collision, load balancing, etc.) when extending the communication cable.
Install ferrite cores	Install ferrite cores approx. 10cm away from the power, I/O terminals and communication connectors to protect against environmental noise.

5.2 Install ferrite core

- Install ferrite core approx. 10cm away from the power, I/O terminals and communication connectors to protect against environmental noise.
- Use the Laird's 28A5776-0A2 or the product that meets the following performance

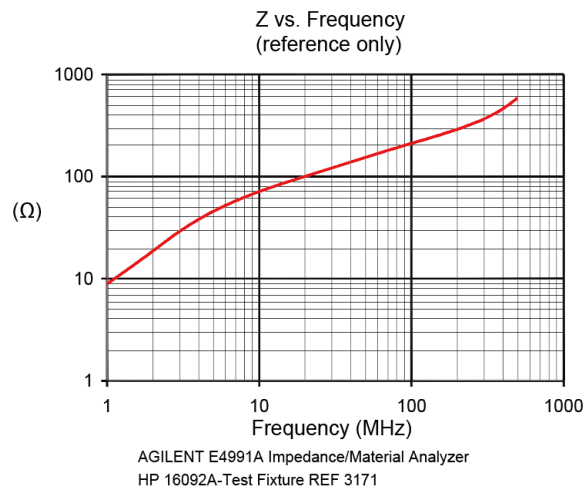

※ Impedance (Z)

Frequency	25MHz	100MHz	300MHz
Normal (REF)	115Ω	210Ω	360Ω
Minimum	-	168Ω	-

5.3 Connector specifications



Caution

- Based on the user's environment, nonrated (e.g., solid wire) wire can be used. However, it may result in personal injury or economic loss.

- Wiring method: Screwless
- Connection type: Pin connector, pin terminal
- Length of connection: 8 to 12 mm (rated length: 10 mm)
- Wire gauge: AWG 22 - 16 (rated gauge: AWG 18)
- Current: Max. 2,000mA (1 terminal)
- Voltage: Max. 230VAC (1 terminal)

5.4 Wire ferrule specifications

- Use the UL approved wire ferrule.
- When installing the temperature input module, use wires, and ferrule terminal suitable for the temperature sensor.

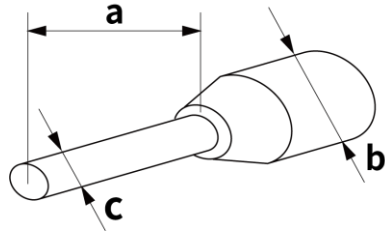

	a	b	c	Certified spec.
Range	8 to 12 mm	≤ 3 mm	0.6 to 1.3 mm	AWG22-16
Recommended	10 mm		1 mm	AWG18

5.5 Connecting & removing

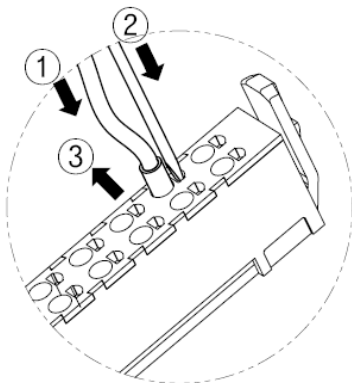

- Connecting: Push the wire ferrule to the direction ①.
- Removing: Put a non-conductive flat head (–) screwdriver (tip width: ≤ 3 mm) to the direction ② at the groove on the terminal. Pull the cable to the direction ③.

6 Earthing and shielding

6.1 Earthing

- Ground the product through the housing frame (e.g., case) when the DIN rail mounting.
- The grounding structure is provided by the spring contacts with metal elastic structure located on the bottom of the base. The grounding structure is shown in the figure below.

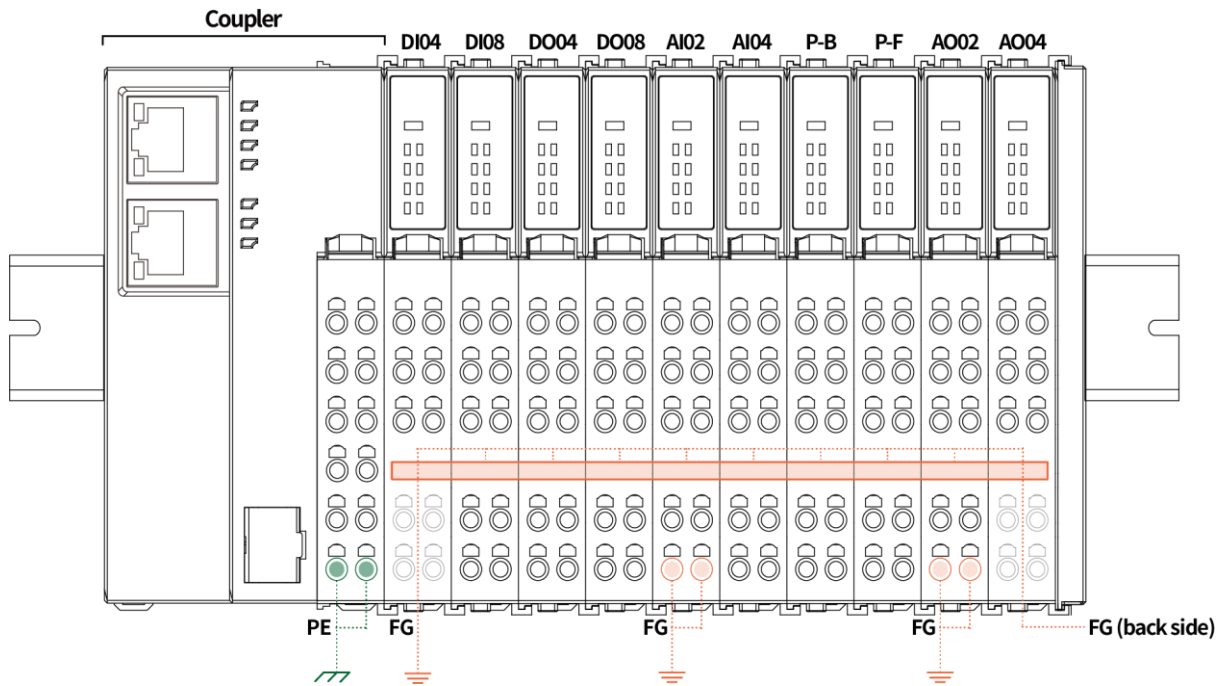

- Side view

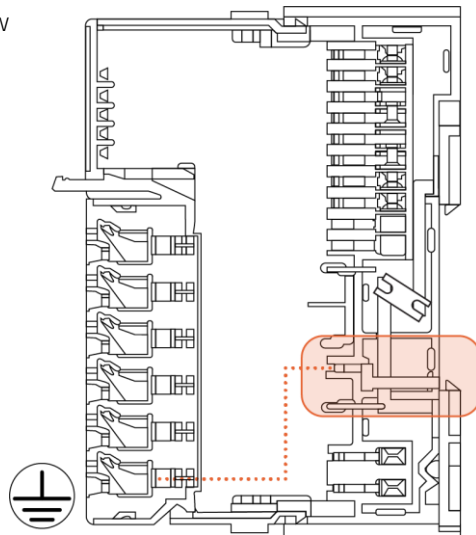

6.2 Shield connecting system

- You can use a shield connecting system to reduce input noise of sensors and more. Shield work is recommendation.
 - Communication cable: Use shielded cables and clamps for improving the signal quality of the communication lines
 - Power cable: Use shield clamp for removing noise that may be generated when power is supplied
 - I/O cable: Use shield clamp for the digital, analog and special modules

6.3 Possible shielding connection

- Take the effective shielding as follows. Be sure not to configure the closed circuit. Improper shielding connection may cause noise.

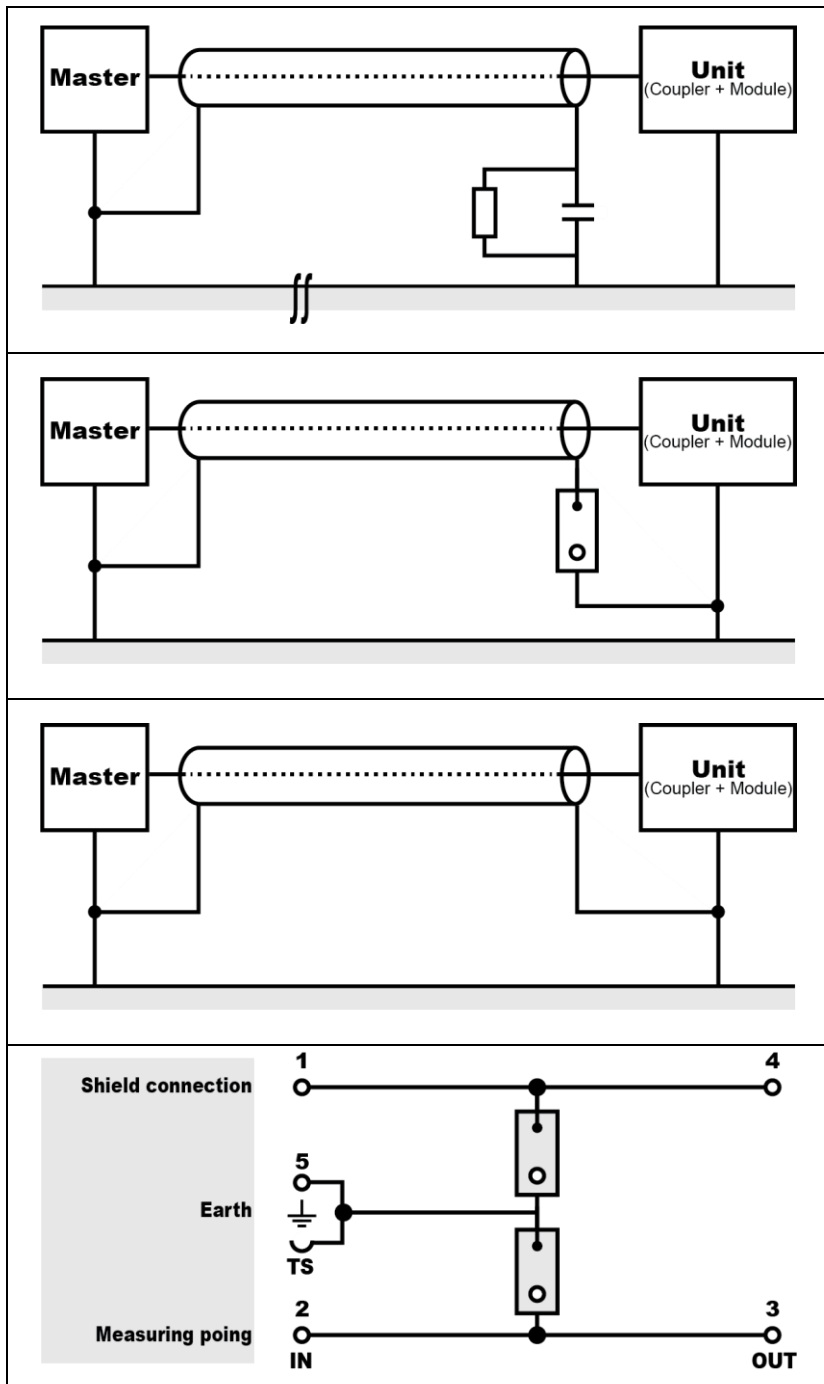

7 Maintenance



Warning

- In case of failure / fault / error situation, if the module does not cause malfunction to the whole system, do not remove the product until the maintenance module comes. If you replace the module with settings, it can be initialized when the coupler is turned off.
- Do not operate the product for a long time under disassembled condition.
- Be sure to replace in the same parts and components that used before. Incorrect combinations may cause damage to the product or system and may result in personal injuries.
- With the terminal / body / base are removed, the internal circuits are vulnerable to the external environment. It may cause damage to the product and system, and personal injuries.
- Do not touch the connector part of the base.
- Do not connect and disconnect the base while power is on.

7.1 Component part of the module

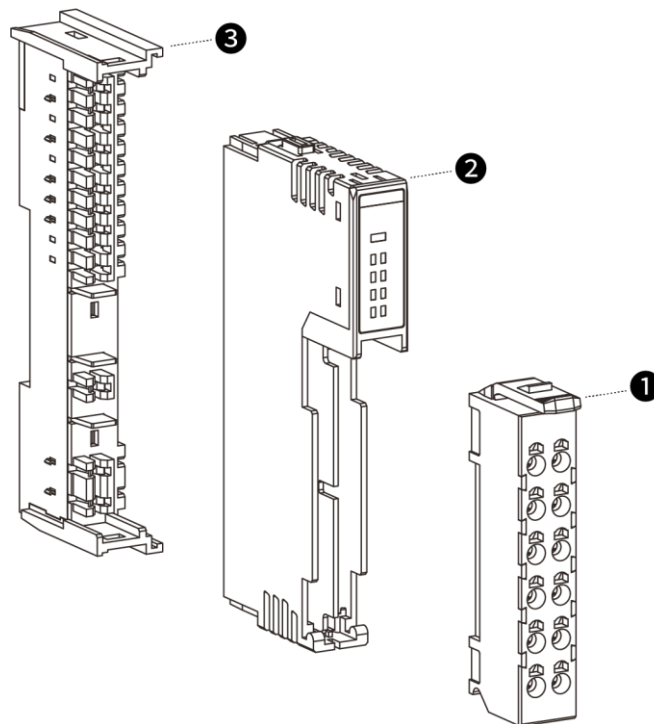

1. Terminal: Part that the input and output signal comes out of the product

2. Body: Part that controls the input and output signal of the product

3. Base: Part that connects the communication (ABUS) and power of the coupler and module

※ The base of IO and power module has a different shape. Beware of that when you install the product or under the Hot-swap condition.

7.2 Body-Terminal disassembly & assembly

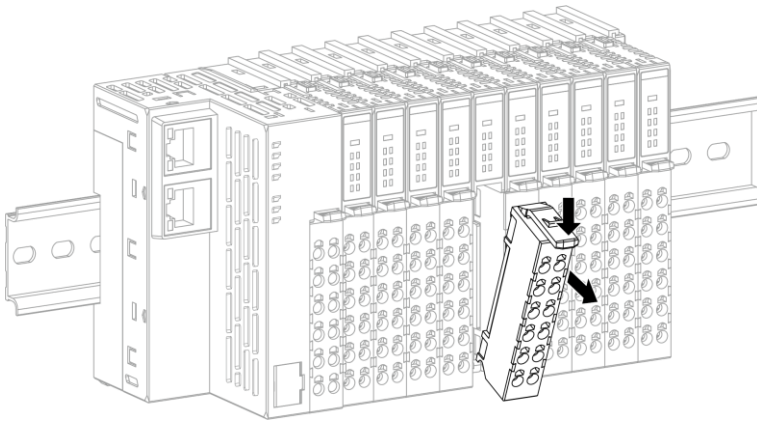

- Disassembly: Press and pull the lever on top of the terminal down.
- Assembly: Support the bottom of the terminal to the bottom of the module and slide it in.

7.3 Base-Body disassembly & assembly

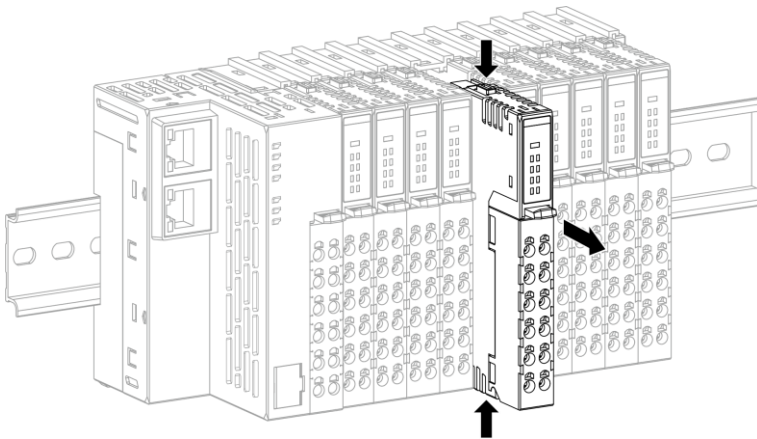

- Disassembly: Press the buttons on the top/bottom of the body at the same time and pull the body.
- Assembly: Push the body in parallel.

7.4 DIN rail-Base disassembly & assembly

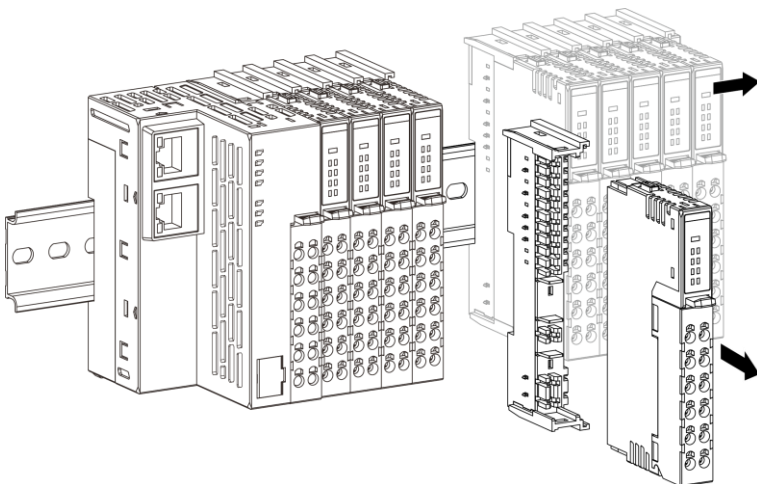

- Disassembly: Detach the inserted modules on the right side of the base to be replaced. Remove the terminal and body and then pull the Rail Lock of the base down. Remove the base from the DIN rail.
- Assembly: Insert new base on the DIN rail. For more information, see “4.4 DIN rail mounting/removing.”

8 Operation

8.1 Workflow

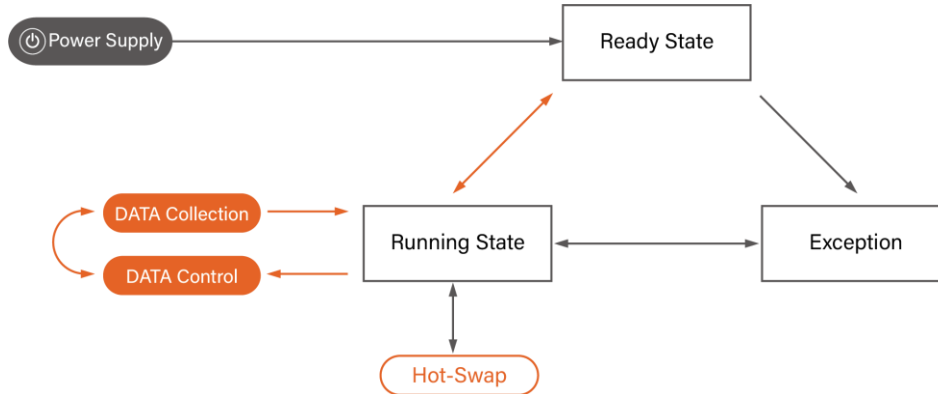

Workflow	Description											
Power supply	Power supply stage of the product											
Ready State	A stage finishing the initialization for the product operation. It is not available to enter this stage when an error occurs in the memory map, un-recognized expansion module, and extension of the modules.											
Running state	<p>The product's operation status consists of the standby mode and run mode. The main roles are data collection and control, and hot-swap.</p> <table border="1"> <tbody> <tr> <td rowspan="4">Standby Mode</td> <td>Waiting state for the Field Network, ABUS communication</td> </tr> <tr> <td>Access to internal file storage area (product configuration and settings)</td> </tr> <tr> <td>Read/write memory map is available in the monitoring mode</td> </tr> <tr> <td>Inadequate settings related to the product operation</td> </tr> <tr> <td rowspan="3">Run Mode</td> <td>Field Network operation, ABUS communication</td> </tr> <tr> <td>Access to internal file storage area (product configuration and settings)</td> </tr> <tr> <td>Read memory map is available in the monitoring mode</td> </tr> <tr> <td>Hot-swap</td> <td>During the operation, replacing the components (terminal and body) is available for the maintenance and restoring the settings automatically.</td> </tr> </tbody> </table>	Standby Mode	Waiting state for the Field Network, ABUS communication	Access to internal file storage area (product configuration and settings)	Read/write memory map is available in the monitoring mode	Inadequate settings related to the product operation	Run Mode	Field Network operation, ABUS communication	Access to internal file storage area (product configuration and settings)	Read memory map is available in the monitoring mode	Hot-swap	During the operation, replacing the components (terminal and body) is available for the maintenance and restoring the settings automatically.
Standby Mode	Waiting state for the Field Network, ABUS communication											
	Access to internal file storage area (product configuration and settings)											
	Read/write memory map is available in the monitoring mode											
	Inadequate settings related to the product operation											
Run Mode	Field Network operation, ABUS communication											
	Access to internal file storage area (product configuration and settings)											
	Read memory map is available in the monitoring mode											
Hot-swap	During the operation, replacing the components (terminal and body) is available for the maintenance and restoring the settings automatically.											
Exception	Processing state that the product detects an abnormal situation.											

8.2 Monitoring

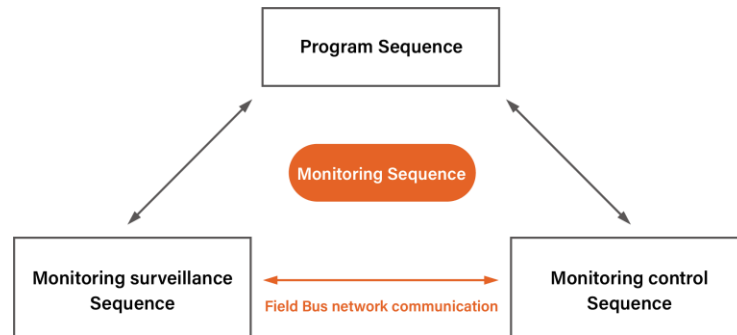

Sequence	Description
Program Sequence	Upload and download settings information of coupler and modules
Monitoring surveillance Sequence	Under the field network is operating, DAQMaster can arbitrarily read the information of the memory map from the coupler
Monitoring control Sequence	Without field network, DAQMaster can arbitrarily modify the information of the memory map from the coupler

9 DAQMaster functions

You can set the parameters, read the modules' information, and control the input/output signals of connected modules via DAQMaster. The 'virtual mode' offers the recommended ARIO system before mounting.

For the detailed information, see the "DAQMaster User Manual."

Functions	Descriptions
Module setting and controlling input/output signal	Edit the property values of the connected modules and control I/O signals
Diagnostic function	<ul style="list-style-type: none"> The ARIO system provides the diagnose information of unit condition and send it to the parent device. Displayed on the I/O monitoring screen
Address map	Check the communication address of the connected modules
I/O monitor	Check or set the I/O signal of the connected modules
Virtual mode	<ul style="list-style-type: none"> You can configure a virtual ARIO system without the product connection. User-friendly 'Recommended sorting' function
Firmware update	<ul style="list-style-type: none"> Update the coupler's firmware via the CONFIG terminal

10 Appendix

10.1 Glossary

Field Network	The collective term for FieldBus and Industrial EtherNet; this communication network enables distributed control of input/output signals in the plant and process automation equipment. (※ IEC61158 doesn't define this terminology. In the standard, it is explained as FieldBus.)
FieldBus	The industrial network that is designed for the field of automation, using real-time, reliability and data flow based on the serial communication. (e.g., CC-Link, ProfiBus, DeviceNet, Modbus RTU, etc.) (※ This term has shortly defined the definition from IEC61158)
Autonics BUS (ABUS)	In ARIO series, this protocol means communication between the coupler and module. This is a type of communication topology that enables sending and receiving information and signals, and sharing a single-wire communication circuit. (e.g., internet hub)
Industrial EtherNet	The industrial network that is designed for the field of automation, using real-time, reliability and data flow based on EtherNet communication. (e.g., EtherCAT, ProfiNet, EtherNet/IP, Modbus TCP, etc.)
Coupler	It operates as a slave, exchanging data with the master of field network, and managing input/output of modules.
Module	It exchanges data with the coupler and manages input/output.
Unit	The assembled component with the coupler and modules to provide separate functions.
Channel	- One digital signal (Bit data), (e.g., 8 signals are represented by 8 Channels) - One analog signal (Word data), (e.g., 4 signals are represented by 4 Channels)
Node	The unit that master recognizes slaves (coupler) in field network. (In case of field network environment consists of one master and three slaves, there are 3 nodes.)
Hole	Multiple circle-shaped holes where the signal cable is connected. The half-circle shaped holes are the mounting hole to connect/remove the signal cable and to grasp the status of the hole.
Connector	Sold separately to connect the main part of ARIO product and external signal cable. (EtherNet connector, ARIO terminal, D-SUB 9PIN connector, etc.)
Terminal	One of the assembled components in ARIO series, providing a combination of signal and power cable to receive signals and power.
Body	One of the assembled components in ARIO series, controlling and managing the major functions of the module.
Base	One of the assembled components in ARIO series, configuring ABUS to provide ABUS power, ABUS communication line and Field power (I/O signal level).
Memory	The area managing all information dealt with ARIO series – input/output, diagnosis, setting information, etc.
DAQMaster	The industrial software to gather and monitor the settings and data of the ARIO series.
Hot-swap	The function to support product maintenance and replacement during operation when the error or malfunction occurs at the ARIO unit.
Bit	The data type represented by ON/OFF
Word	The data size that the system can process it at once. (※ In general, 16 bits = 1 word in the industrial system.)
Bypass power	In the Hot-swap function, this power line enables the power supply to the next module, even if the body of the module is removed.
Cut-off power	In the Hot-swap function, this power line cut-off the power supply to the next module, if the body of the module is removed.
Memory map	The data row that the coupler and module are separately managing or that the master of field network configures orders/settings of the slaves.

Make Life Easy: Autonics