

# Autonics TIMER LE4SA INSTRUCTION MANUAL



Thank you for choosing our Autonics product.  
Please read the following safety considerations before use.

## Safety Considerations

- ⚠ Please observe all safety considerations for safe and proper product operation to avoid hazards.
- ⚠ symbol represents caution due to special circumstances in which hazards may occur.
- ⚠ **Warning** Failure to follow these instructions may result in serious injury or death.
- ⚠ **Caution** Failure to follow these instructions may result in personal injury or product damage.

### Warning

- Fail-safe device must be installed when using the unit with machinery that may cause serious injury or substantial economic loss.** (e.g. nuclear power control, medical equipment, ships, vehicles, railways, aircraft, combustion apparatus, safety equipment, crime/disaster prevention devices, etc.) Failure to follow this instruction may result in fire, personal injury, or economic loss.
- Install on a device panel to use.** Failure to follow this instruction may result in electric shock or fire.
- Do not connect, repair, or inspect the unit while connected to a power source.** Failure to follow this instruction may result in electric shock or fire.
- Check 'Connections' before wiring.** Failure to follow this instruction may result in fire or explosion.
- Do not disassemble or modify the unit.** Failure to follow this instruction may result in electric shock or fire.

### Caution

- When connecting the power/sensor input and relay output, use AWG 20(0.50mm<sup>2</sup>) cable or over and tighten the terminal screw with a tightening torque of 0.74 to 0.90N·m.** Failure to follow this instruction may result in fire or malfunction due to contact failure.
- Use the unit within the rated specifications.** Failure to follow this instruction may result in fire or product damage.
- Use dry cloth to clean the unit, and do not use water or organic solvent.** Failure to follow this instruction may result in electric shock or fire.
- Do not use the unit in the place where flammable/explosive/corrosive gas, humidity, direct sunlight, radiant heat, vibration, impact, or salinity may be present.** Failure to follow this instruction may result in fire or explosion.
- Keep metal chip, dust, and wire residue from flowing into the unit.** Failure to follow this instruction may result in fire or product damage.

## Ordering Information

LE	4	S	A	Output	No mark	Time-limit 1c
				Size	A	Time-limit 2c, Time-limit 1c+Instantaneous 1c (selectable)
				Digit	S	DIN W48×H48mm
				Item	4	9999 (4-digit)
					LE	LCD Timer (touch type)

※8-pin socket (PG-08, PS-08(N)) is sold separately.

## Dimensions

(unit: mm)

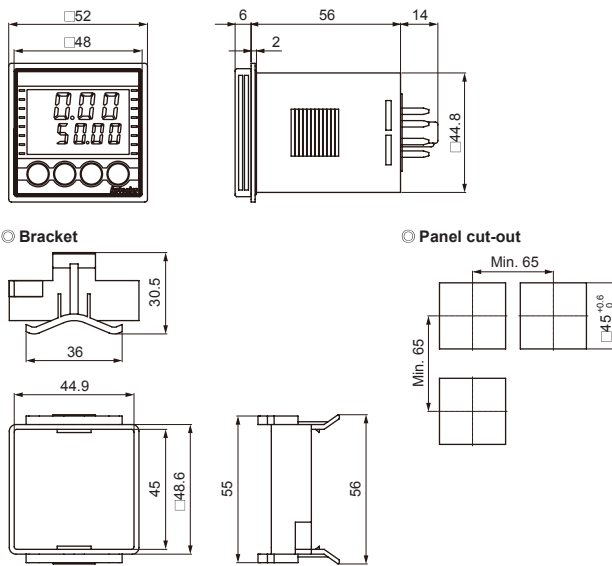

## Specifications

Model	LE4SA	
Display method	LCD display (backlight)	
Power supply	24-240VAC ~ 50/60Hz, 24-240VDC = universal	
Allowable voltage range	90 to 110% of rated voltage	
Power consumption	Max. 4VA (24-240VAC ~ 50/60Hz), max. 1.6W (24-240VDC =)	
Return time	Max. 100ms	
Timing operation	Power ON Start	
Control output	Selectable Time limit DPDT (2c), Time limit SPDT (1c)+ Instantaneous SPDT (1c) (depends on operation mode)	
Contact capacity	250VAC ~ 3A, 30VDC = 3A resistive load	
Mechanical life cycle	Min. 10,000,000 operations	
Electrical life cycle	Min. 100,000 operations (at rated contact capacity)	
Repeat Set Voltage-Temperature error	Max. ±0.01% ±0.05sec	
Insulation resistance	Over 100MΩ (at 500VDC megger)	
Dielectric strength	2,000VAC 50/60Hz for 1 minute	
Noise immunity	±2kV the square wave noise (pulse width: 1us) by the noise simulator	
Vibration	Mechanical	0.75mm amplitude at frequency of 10 to 55Hz (for 1 min) in each X, Y, Z direction for 1 hour
	Malfunction	0.5mm amplitude at frequency of 10 to 55Hz (for 1 min) in each X, Y, Z direction for 10 minutes
Shock	Mechanical	300m/s <sup>2</sup> (approx. 30G) in each X, Y, Z direction for 3 times
	Malfunction	100m/s <sup>2</sup> (approx. 10G) in each X, Y, Z direction for 3 times
Environment	Ambient temp.	-10 to 55°C, storage: -25 to 65°C
	Ambient humi.	35 to 85%RH
Approval	CE, UL, etc.	
Unit weight	Approx. 98g	

※Environment resistance is rated at no freezing or condensation.

## Connection

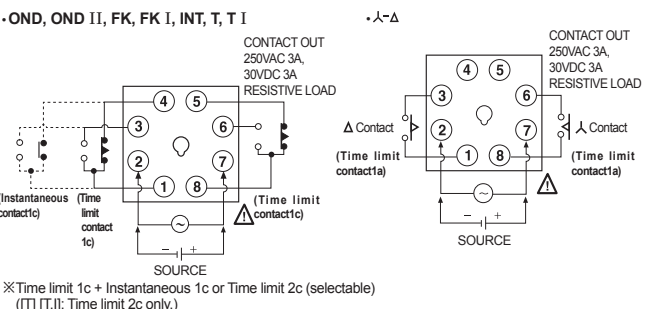

※The above specifications are subject to change and some models may be discontinued without notice.  
※Be sure to follow cautions written in the instruction manual and the technical descriptions (catalog, homepage).

## Unit Description

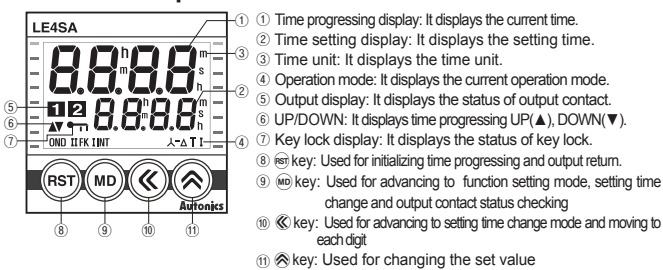

## Function Setting Mode Descriptions

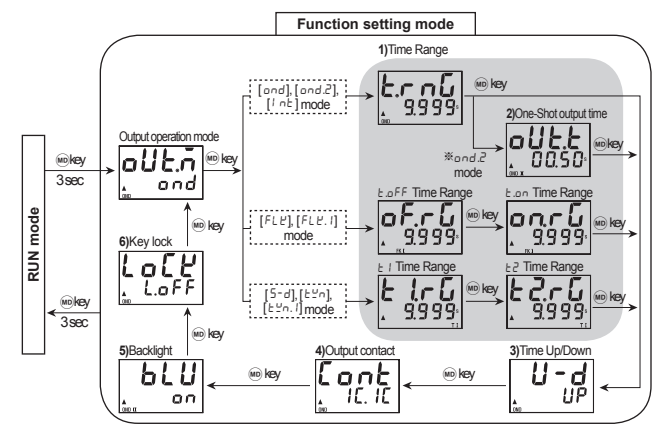

### 1) Time Range

Parameter	Time range specification
9.999~(9.999s)	0.010 sec to 9.999 sec
99.99~(99.99s)	0.01 sec to 99.99 sec
999.9~(999.9s)	0.1 sec to 999.9 sec
9999~(9999s)	1 sec to 9999 sec
99.99~(99m59s)	0 min 01 sec to 99 min 59 sec
999.9~(999.9m)	0.1 min to 999.9 min
9999~(9999m)	1 min to 9999 min
99.99~(99h59m)	0 hour 01 min to 99 hour 59 min
999.9~(999.9h)	0.01 hour to 999.9 hour
9999~(9999h)	0.1 hour to 9999 hour
9999~(9999h)	1 hour to 9999 hour

### 2) One-Shot output time setting

It will be activated when selecting ON Delay 2(One-Shot output mode). (Time setting: 0.01 sec to 99.99 sec)

### 3) Time progress UP/DOWN setting

UP[UP]: Time progressed from 0 to setting time.  
DOWN[DN]: Time progressed from setting time to 0.

### 4) Output contact setting

Set the relay contact (No.1, 3, 4 pin) to Instantaneous or Time limit. [IC, IC]: Instantaneous 1c, Time limit 1c, [2C] Time limit 2c. It is fixed to Time limit 2c in star-delta, Twin and Twin 1 modes.

### 5) Backlight setting

Set Backlight (ON[on], OFF[off]).

### 6) Key Lock selection

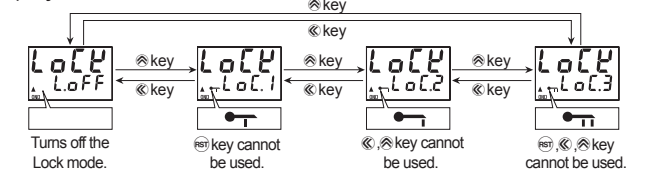

## Time Setting

### Output operation mode: OND, OND II, INT

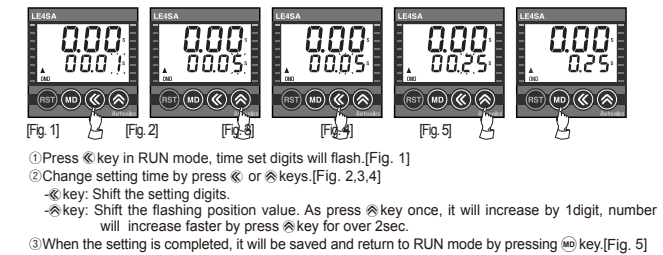

### Output operation mode: FK, FK I

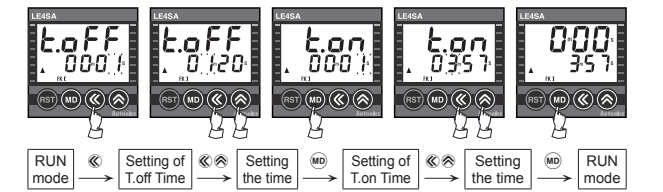

### Output operation mode: A-Δ, T, T I

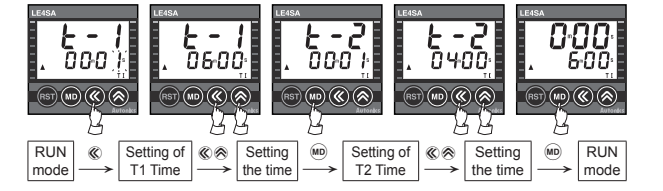

※Setting time changes can be made during timing operation. Make sure that timing operation is continuously progressed while changing the setting time.  
※If pressing key while setting time is shorter than min. setting time, setting value will be flickering three times and it will be returned to setting mode again, not to RUN mode.  
※If there is no additional key operations after entering into setting mode, it will be return to RUN mode.(Setting value is not saved.)  
※Min. Setting time: 0.01 sec.(In case of OND and OND II modes, it is able to set 0 since no min. setting time is applied.)

## Factory Default

NO.	Parameter	Default
1	Output operation mode	oUt.n
2	Time Range	t.rnG 99.99s
3	Time Up/Down	U-d UP
4	Output contact	Cont IC.IC
5	Backlight	bLU on
6	Key Lock	LoCk LoCk1
7	Setting time	- 50.00s

## Output Operation Mode

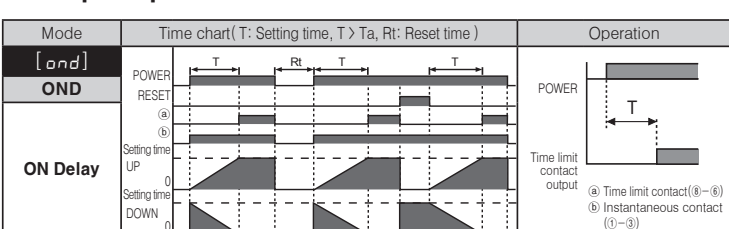

- Timing operation starts when power is ON.
- Time limit output will be ON when timing operation is progressed up to the setting time. Display value will be HOLD.
- If selecting time limit 1c + instantaneous 1c mode, instantaneous output will be ON when power is ON and goes OFF when power is OFF.
- If pressing RESET key, display value and time limit output will be reset.

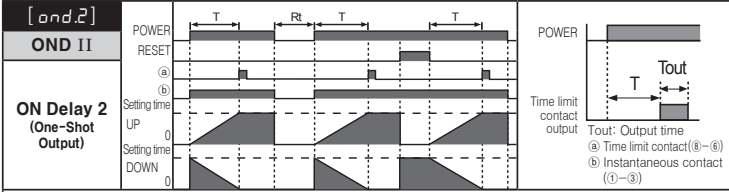

- Timing operation starts when power is ON.
- Time limit output will be ON during Tout setting time and goes OFF when timing operation is progressed up to the setting time. Display value will be HOLD.
- If selecting time limit 1c + instantaneous 1c mode, instantaneous output will be ON when power is ON and goes OFF when power is OFF.
- If pressing RESET key, display value and time limit output will be reset.
- Tout setting range: 0.01 sec to 99.99 sec.

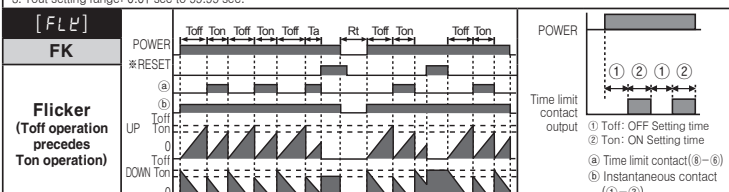

- Control output will be repeatedly OFF during Toff setting time and will be ON during Ton setting time when power is ON.
- If selecting time limit 1c + instantaneous 1c mode, instantaneous output will be ON when power is ON and goes OFF when power is OFF.
- If pressing RESET key, display value and time limit output will be reset.
- It is able to set each Toff time and Ton time separately. In [FLP.1] mode, timing operation starts with Toff.

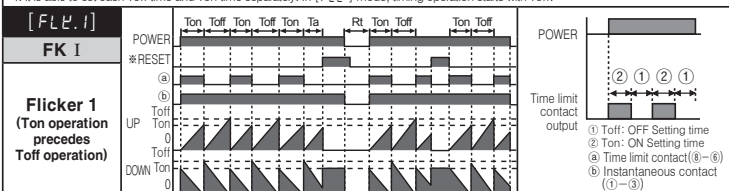

- Control output will be repeatedly ON during Ton setting time and will be OFF during Toff setting time when power is ON.
- If selecting time limit 1c + instantaneous 1c mode, instantaneous output will be ON when power is ON and goes OFF when power is OFF.
- If pressing RESET key, display value and time limit output will be reset.
- It is able to set each Ton time and Toff time separately. In [FLP.1] mode, timing operation starts with Ton.

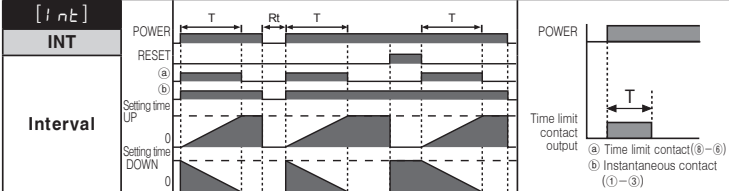

- Time limit output will be ON when power is ON and Timing operation starts.
- Time limit output will be OFF when timing operation is progressed up to the setting time. Display value will be HOLD.
- If selecting time limit 1c + instantaneous 1c mode, instantaneous output will be ON when power is ON and goes OFF when power is OFF.
- If pressing RESET key, display value and time limit output will be reset.

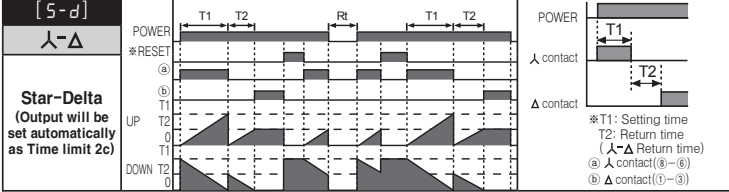

- A contact will be ON when power is ON and Timing operation starts.
- A contact will be OFF when timing operation is progressed up to the T1 setting time. Timing operation will be reset and started again.
- A contact will be ON when timing operation is progressed up to the T2 switching time. Display value will be HOLD.
- If pressing RESET key, display value and A-Δ contacts will be reset.
- It is able to set each T1 and T2 time separately.

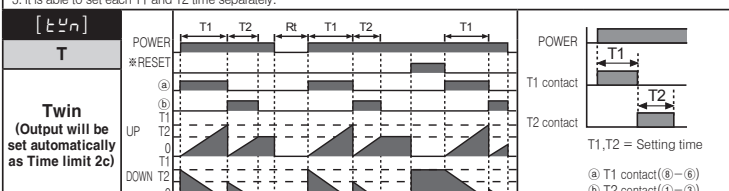

- T1 contact will be ON when power is ON and Timing operation starts.
- T1 contact will be OFF and T2 contact will be ON when timing operation is progressed up to the T1 setting time. Timing operation will be reset and started again. T2 contact will be OFF when timing operation is progressed up to the T2 setting time. Display value will be HOLD.
- If pressing RESET key, display value and T1, T2 contacts will be reset.
- It is able to set each T1 and T2 time separately.

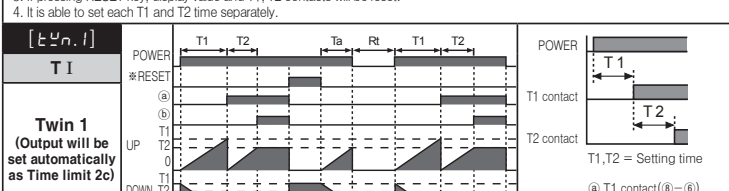

- Timing operation starts when power is ON.
- T1 contact will be ON when timing operation is progressed up to the T1 setting time. Timing operation will be reset and started again.
- T2 contact will be ON when timing operation is progressed up to the T2 setting time. Display value will be HOLD.
- If pressing RESET key, display value and T1, T2 contacts will be reset.
- It is able to set each T1 and T2 time separately.

※Reset: Up mode -> Display value is '0', Output is 'OFF'.  
DOWN mode -> Display value is 'setting time', Output is 'OFF'.

## Cautions during Use

- Follow instructions in 'Cautions during Use'. Otherwise, it may cause unexpected accidents.
- When supplying or turning off the power, use a switch or etc. to avoid chattering.
- Install a power switch or circuit breaker in the easily accessible place for supplying or disconnecting the power.
- Keep away from high voltage lines or power lines to prevent inductive noise. In case installing power line and input signal line closely, use line filter or varistor at power line and shielded wire at input signal line. Do not use near the equipment which generates strong magnetic force or high frequency noise.
- This unit may be used in the following environments.
  - ①Indoors (in the environment condition rated in 'Specifications')
  - ②Altitude max. 2,000m
  - ③Pollution degree 2
  - ④Installation category II

## Major Products

- Photoelectric Sensors
- Fiber Optic Sensors
- Door Sensors
- Door Side Sensors
- Area Sensors
- Proximity Sensors
- Pressure Sensors
- Rotary Encoders
- Connector/Sockets
- Switching Mode Power Supplies
- Control Switches/Lamps/Buzzers
- I/O Terminal Blocks & Cables
- Stepper Motors/Drivers/Motion Controllers
- Graphic/Logic Panels
- Field Network Devices
- Laser Marking System (Fiber, Co<sub>2</sub>, Nd:YAG)
- Laser Welding/Cutting System
- Temperature Controllers
- Temperature/Humidity Transducers
- SSRs/Power Controllers
- Counters
- Timers
- Panel Meters
- Tachometer/Pulse (Rate)Meters
- Display Units
- Sensor Controllers

**Autonics Corporation**  
http://www.autonics.com

HEADQUARTERS:  
18, Bansong-ro 513beon-gil, Haeundae-gu, Busan,  
South Korea, 48002  
TEL: 82-51-519-3232  
E-mail: sales@autonics.com