

CONTENTS 目录



338/358
风机过滤器
Fan Filter



359/364
三合一豪华防尘网罩
Three-in-one luxurious dust-proof mesh cover

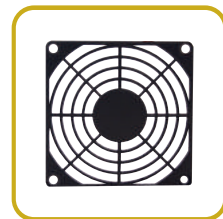

365/366
单片防护塑网
Single protective Plastics Grid

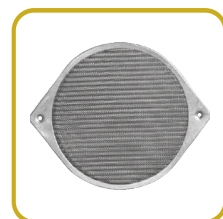

367/368
金属屏蔽网罩
Metal Screen

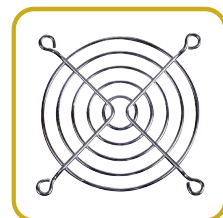

369/371
金属防护网罩
Metal Protection Mesh Cover

本样册仅做选型参考,具体以规格书为准。
This sample book is for reference only. Please refer to the specification for details.
如需特殊电压也可根据洽询提供, 本公司保留技术改动权利。
Special voltage may be provided if necessary according to the inquiry. Jiulong all technical modification rights reserved.

九龙电机

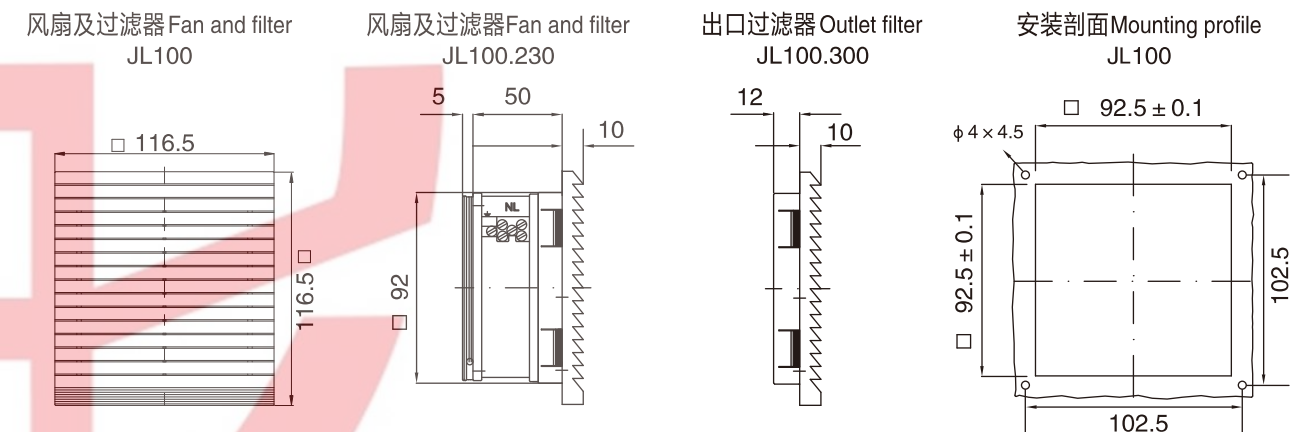
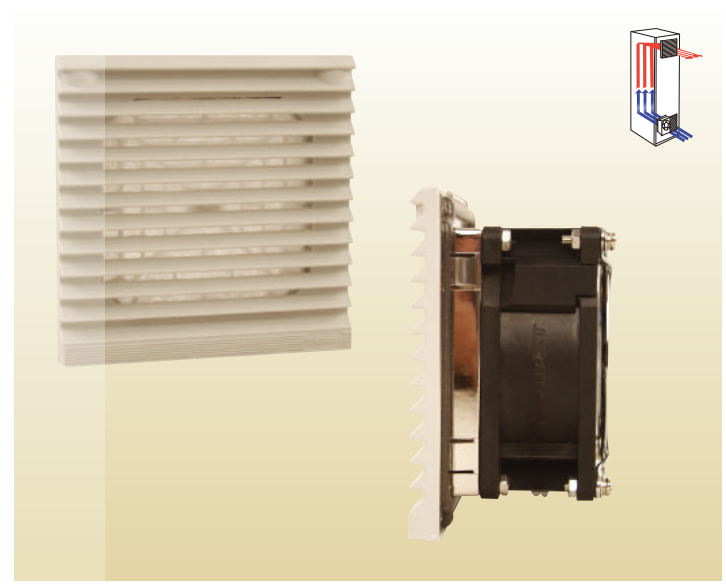
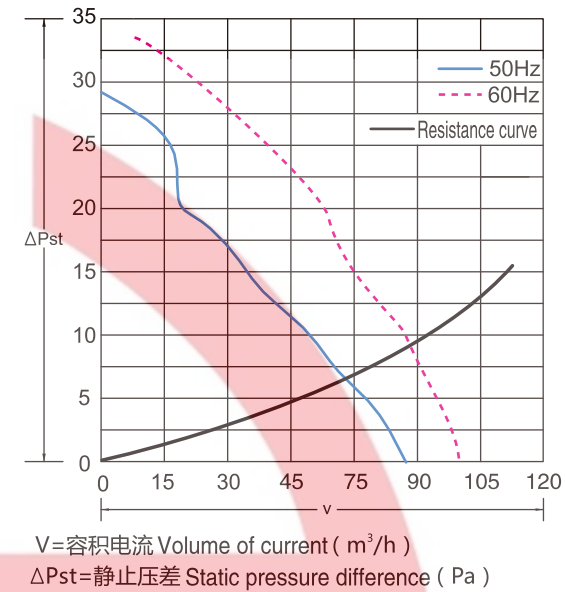

气流参数 Airflow parameter	JL100.230	JL100.115	JL100.024	JL100.048
电压/频率 Voltage/frequency	230V/50/60Hz(AC)	115V/50/60Hz(AC)	24V(DC)	48V(DC)
过滤垫*Filter mat	150 g/m ²	150 g/m ²	150 g/m ²	150 g/m ²
气流风量 Airflow/blast volume	70/75m ³ /h			
最大静压(风量 = 0 m ³ /h) Max. static pressure (blast volume=0m ³ /h)	29 Pa			
过滤效率 Filtration efficiency	73%			
过滤垫等级 Filter mat grade(DIN EN 779)	G 2			
噪音 Noise (DIN 45 635)	39 dB (A)			
负载率 Load rate	100%			
使用温度 The use of temperature	-30°C~+70°C			
储藏温度 Storage temperature	-40°C~+80°C			

机械参数 Mechanic parameter	JL100.230	JL100.115	JL100.024	JL100.048
外形尺寸 mm(高度 × 宽度 × 安装深度) Dimensions (height * width * mounting depth)	116 × 116 × 55 116 × 116 × 43	116 × 116 × 55 116 × 116 × 43	116 × 116 × 55	
轴承类型 Type of bearing	滚珠轴承 Ball bearing			
安装方向 Mounting direction	任一种, 推荐水平方式 Any direction (horizontal mounting is recommended)			
结构材料 Structure material	阻燃ABS-FR 符合 UL 94 VO Inflamming retarding ABS-FR conforming to the UL 94 VO			
重量 Weight	0.4kg	0.4kg	0.34kg	
安全等级 Security grade	依据 EN 60529 According to the EN 60529			
颜色 Colour	RAL 7035, 其它颜色可选 and other colours optional			
连接件 Connection	端子板 Terminal board			
已有认证 Certificate	RoHS、UL、EMC、CE、			
防护等级 IP code	IP54			
过滤棉型号和尺寸 Filter cotton types/dimensions	87 × 87 × 3mm			
过滤棉防护等级 Filter cotton protection grade	符合 UL94V0			

AC Axial Fan
AC轴流风机

AC All-Metal Axial Fan
AC全金属轴流风扇

DC Axial Fan
DC轴流风机

DC Centrifugal Fan
DC离心风机

EC Axial Fan
EC轴流风机

EC Centrifugal Fan
EC离心风机

AC Centrifugal Fan
AC离心风机

Fan Accessories
风机配件

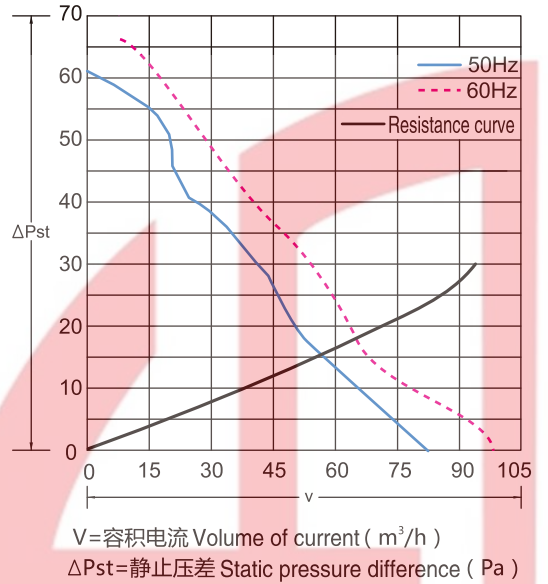

风扇及过滤器 Fan and filter
JL200

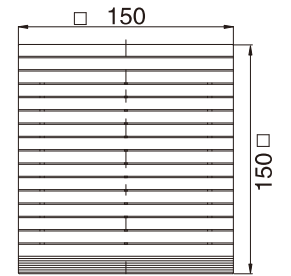

风扇及过滤器 Fan and filter
JL200.230

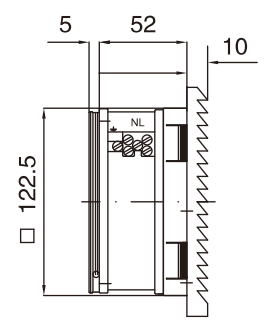

出口过滤器 Outlet filter
JL200.300

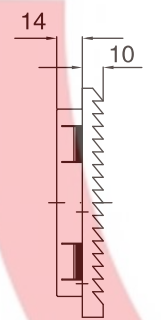

安装剖面 Mounting profile
JL200

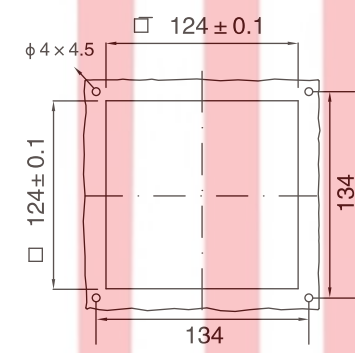

气流参数 Airflow parameter	JL200.230	JL200.115	JL200.024	JL200.048
电压/频率 Voltage/frequency	230V/50/60Hz(AC)	115V/50/60Hz(AC)	24V(DC)	48V(DC)
过滤垫*Filter mat	150 g/m ²	150 g/m ²	150 g/m ²	150 g/m ²
气流风量 Airflow/blast volume	105/120m ³ /h			
最大静压(风量 = 0 m ³ /h) Max. static pressure (blast volume=0m ³ /h)	61 Pa			
过滤效率 Filtration efficiency	73%			
过滤垫等级 Filter mat grade(DIN EN 779)	G 2			
噪音 Noise (DIN 45 635)	46/49 dB (A)			
负载率 Load rate	100%			
使用温度 The use of temperature	-30℃~+70℃			
储藏温度 Storage temperature	-40℃~+80℃			

机械参数 Mechanic parameter	JL200.230	JL200.115	JL200.024	JL200.048
外形尺寸 mm(高度×宽度×安装深度) Dimensions (height * width * mounting depth)	150x150x57	150x150x57	150x150x57	
轴承类型 Type of bearing	滚珠轴承 Ball bearing			
安装方向 Mounting direction	任一种, 推荐水平方式 Any direction (horizontal mounting is recommended)			
结构材料 Structure material	阻燃ABS-FR 符合 UL 94 VO Inflaming retarding ABS-FR conforming to the UL 94 VO			
重量 Weight	0.62kg	0.62 kg	0.41kg	
安全等级 Security grade	依据 EN 60529 According to the EN 60529			
颜色 Colour	RAL 7035, RAL 7032, 其它颜色可选 and other colours optional			
连接件 Connection	端子板 Terminal board			
已有认证 Certificate	RoHS、UL、EMC、CE、			
防护等级 IP code	IP54			
过滤棉型号和尺寸 Filter cotton types/dimensions	116×116×10mm			
过滤棉防护等级 Filter cotton protection grade	符合UL94V0			

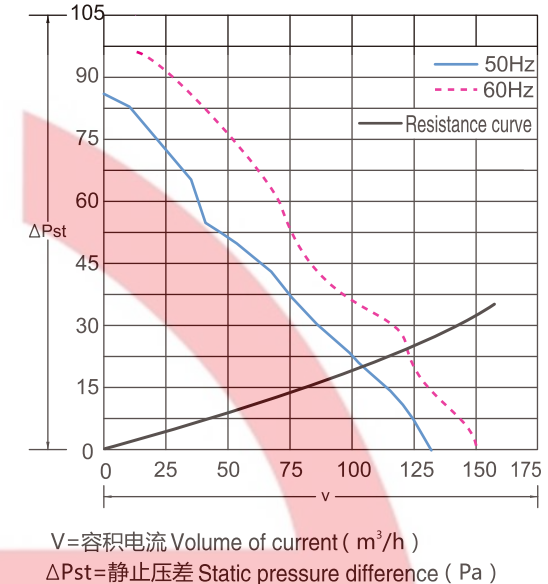

风扇及过滤器 Fan and filter
JL300

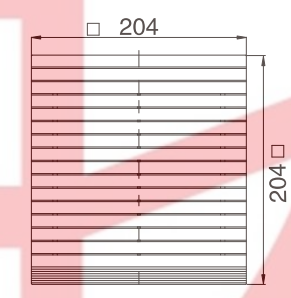

风扇及过滤器 Fan and filter
JL300.230

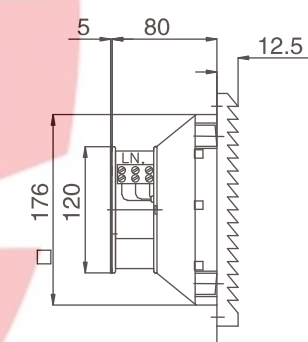

出口过滤器 Outlet filter
JL300.300

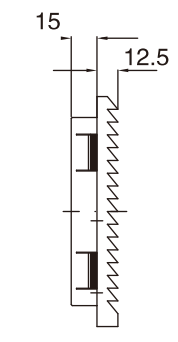

安装剖面 Mounting profile
JL300

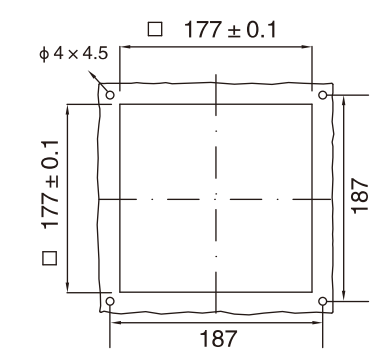

气流参数 Airflow parameter	JL300.230	JL300.115	JL300.024	JL300.048
电压/频率 Voltage/frequency	230V/50/60Hz(AC)	115V/50/60Hz(AC)	24V(DC)	48V(DC)
过滤垫*Filter mat	150 g/m ²	150 g/m ²	150 g/m ²	150 g/m ²
气流风量 Airflow/blast volume	105/120m ³ /h			
最大静压(风量 = 0 m ³ /h) Max. static pressure (blast volume=0m ³ /h)	86 Pa			
过滤效率 Filtration efficiency	73%			
过滤垫等级 Filter mat grade(DIN EN 779)	G 2			
噪音 Noise (DIN 45 635)	46/49 dB (A)			
负载率 Load rate	100%			
使用温度 The use of temperature	-30℃~+70℃			
储藏温度 Storage temperature	-40℃~+80℃			

机械参数 Mechanic parameter	JL300.230	JL300.115	JL300.024	JL300.048
外形尺寸 mm(高度×宽度×安装深度) Dimensions (height * width * mounting depth)	204x204x85	204x204x85	204x204x85	
轴承类型 Type of bearing	滚珠轴承 Ball bearing			
安装方向 Mounting direction	任一种, 推荐水平方式 Any direction (horizontal mounting is recommended)			
结构材料 Structure material	阻燃ABS-FR 符合 UL 94 VO Inflaming retarding ABS-FR conforming to the UL 94 VO			
重量 Weight	0.77kg	0.77 kg	0.55kg	
安全等级 Security grade	依据 EN 60529 According to the EN 60529			
颜色 Colour	RAL 7035, RAL 7032, 其它颜色可选 and other colours optional			
连接件 Connection	端子板 Terminal board			
已有认证 Certificate	RoHS、UL、EMC、CE、			
防护等级 IP code	IP54			
过滤棉型号和尺寸 Filter cotton types/dimensions	170×170×10mm			
过滤棉防护等级 Filter cotton protection grade	符合UL94V0			

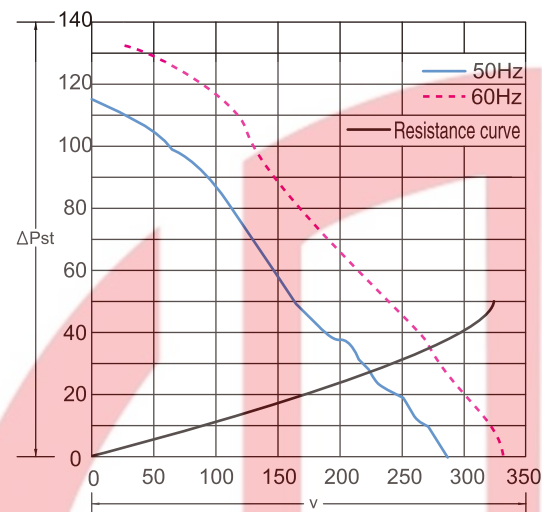
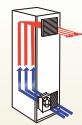

V=容积电流 Volume of current (m³/h)
ΔPst=静止压差 Static pressure difference (Pa)

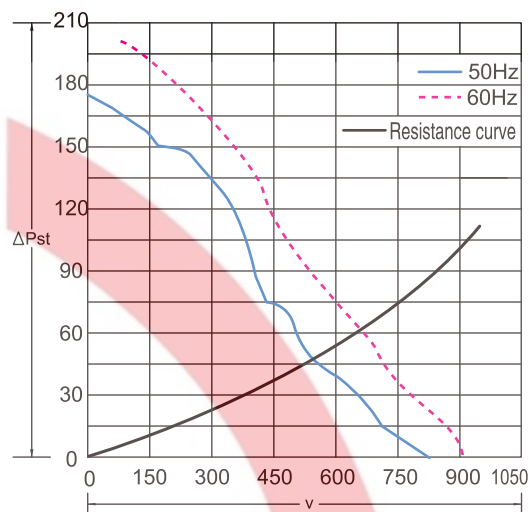

V=容积电流 Volume of current (m³/h)
ΔPst=静止压差 Static pressure difference (Pa)

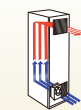

风扇及过滤器 Fan and filter
JL400

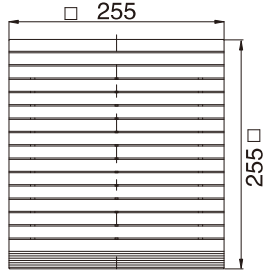

风扇及过滤器 Fan and filter
JL400.230

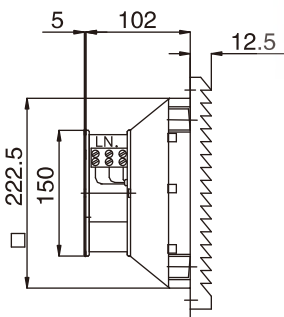

出口过滤器 Outlet filter
JL400.300

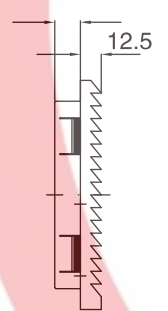

安装剖面 Mounting profile
JL400

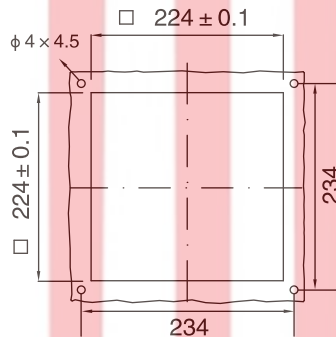

风扇及过滤器 Fan and filter
JL500

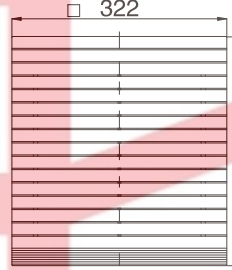

风扇及过滤器 Fan and filter
JL500.230

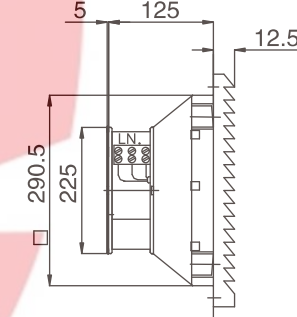

出口过滤器 Outlet filter
JL500.200

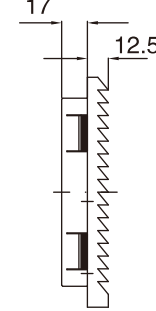

安装剖面 Mounting profile
JL500

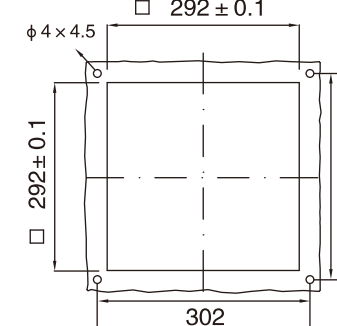

气流参数 Airflow parameter	JL400.230	JL400.115	JL400.024	JL200.048
电压/频率 Voltage/frequency	230V/50/60Hz(AC)	115V/50/60Hz(AC)	24V(DC)	48V(DC)
过滤垫*Filter mat	150 g/m ²	150 g/m ²	150 g/m ²	150 g/m ²
气流风量 Airflow/blast volume	230/265m ³ /h			
最大静压(风量 = 0 m ³ /h) Max. static pressure (blast volume=0m ³ /h)	115 Pa			
过滤效率 Filtration efficiency	73%			
过滤垫等级 Filter mat grade(DIN EN 779)	G 2			
噪音 Noise (DIN 45 635)	54/56 dB (A)			
负载率 Load rate	100%			
使用温度 The use of temperature	-30°C~+70°C			
储藏温度 Storage temperature	-40°C~+80°C			

机械参数 Mechanic parameter	JL400.230	JL400.115	JL400.024	JL400.048
外形尺寸 mm(高度 × 宽度 × 安装深度) Dimensions (height * width * mounting depth)	255x255x107	255x255x107	255x255x107	
轴承类型 Type of bearing	滚珠轴承 Ball bearing			
安装方向 Mounting direction	任一种, 推荐水平方式 Any direction (horizontal mounting is recommended)			
结构材料 Structure material	阻燃ABS-FR 符合 UL 94 VO Inflamming retarding ABS-FR conforming to the UL 94 VO			
重量 Weight	1.5kg	1.5 kg	1.2kg	
安全等级 Security grade	依据 EN 60529 According to the EN 60529			
颜色 Colour	RAL 7035, RAL 7032, 其它颜色可选 and other colours optional			
连接件 Connection	端子板 Terminal board			
已有认证 Certificate	RoHS、UL、EMC、CE、			
防护等级 IP code	IP54			
过滤棉型号和尺寸 Filter cotton types/dimensions	220 × 220 × 10mm			
过滤棉防护等级 Filter cotton protection grade	符合 UL94V0			

气流参数 Airflow parameter	JL500.230	JL500.115	JL500.024	JL500.048
电压/频率 Voltage/frequency	230V/50/60Hz(AC)	115V/50/60Hz(AC)	24V(DC)	48V(DC)
过滤垫*Filter mat	150 g/m ²	150 g/m ²	150 g/m ²	150 g/m ²
气流风量 Airflow/blast volume	550/600m ³ /h			
最大静压(风量 = 0 m ³ /h) Max. static pressure (blast volume=0m ³ /h)	176 Pa			
过滤效率 Filtration efficiency	73%			
过滤垫等级 Filter mat grade(DIN EN 779)	G 2			
噪音 Noise (DIN 45 635)	59/61 dB (A)			
负载率 Load rate	100%			
使用温度 The use of temperature	-30°C~+70°C			
储藏温度 Storage temperature	-40°C~+80°C			

机械参数 Mechanic parameter	JL500.230	JL500.115	JL500.024	JL500.048
外形尺寸 mm(高度 × 宽度 × 安装深度) Dimensions (height * width * mounting depth)	322x322x130	322x322x130	322x322x130	
轴承类型 Type of bearing	滚珠轴承 Ball bearing			
安装方向 Mounting direction	任一种, 推荐水平方式 Any direction (horizontal mounting is recommended)			
结构材料 Structure material	阻燃ABS-FR 符合 UL 94 VO Inflamming retarding ABS-FR conforming to the UL 94 VO			
重量 Weight	2.8kg	2.8 kg	2.3kg	
安全等级 Security grade	依据 EN 60529 According to the EN 60529			
颜色 Colour	RAL 7035, RAL 7032, 其它颜色可选 and other colours optional			
连接件 Connection	端子板 Terminal board			
已有认证 Certificate	RoHS、UL、EMC、CE、			
防护等级 IP code	IP54			
过滤棉型号和尺寸 Filter cotton types/dimensions	285 × 285 × 10mm			
过滤棉防护等级 Filter cotton protection grade	符合 UL94V0			

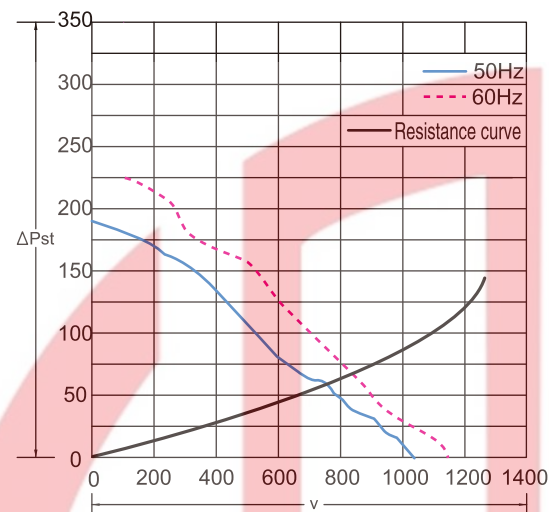

V=容积电流 Volume of current (m³/h)
ΔPst=静止压差 Static pressure difference (Pa)

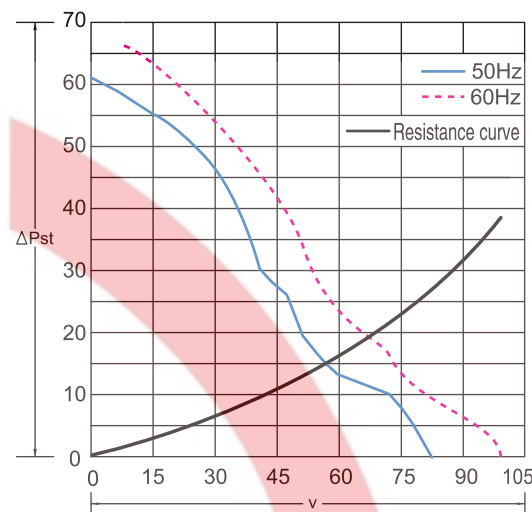

V=容积电流 Volume of current (m³/h)
ΔPst=静止压差 Static pressure difference (Pa)

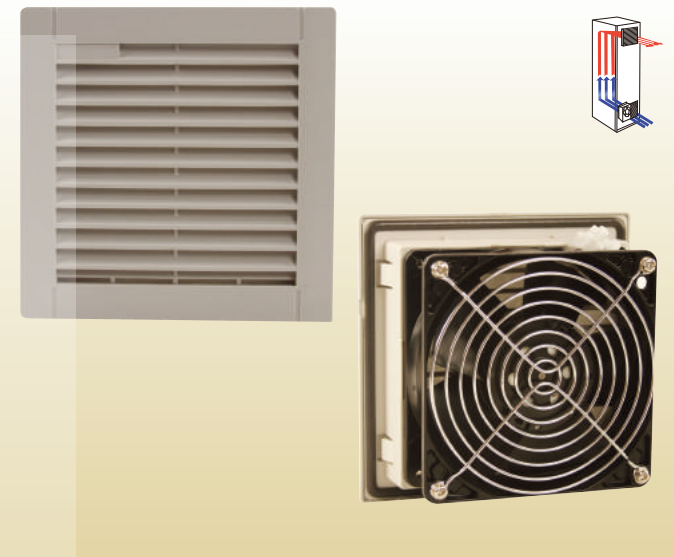

风扇及过滤器 Fan and filter
JL600

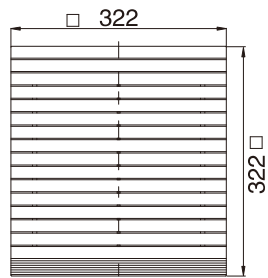

风扇及过滤器 Fan and filter
JL600.230

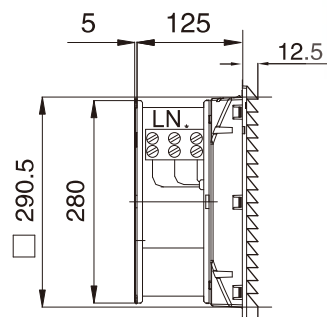

出口过滤器 Outlet filter
JL600.300

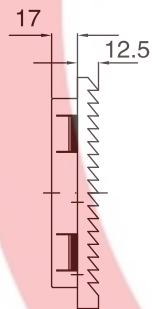

安装剖面 Mounting profile
JL600

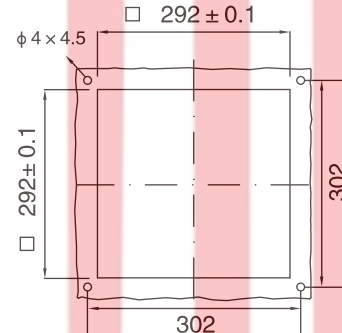

风扇及过滤器 Fan and filter
JL902

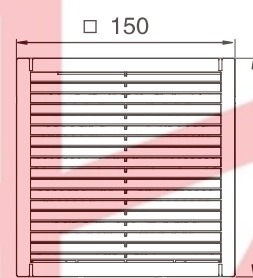

风扇及过滤器 Fan and filter
JL902.230

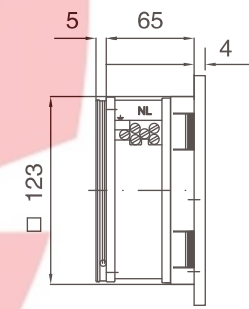

出口过滤器 Outlet filter
JL902.200

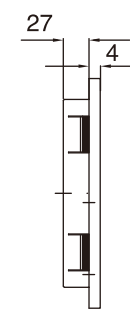

安装剖面 Mounting profile
JL902

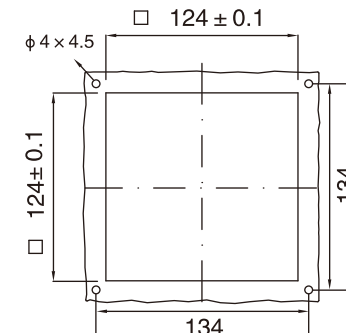

气流参数 Airflow parameter	JL600.230	JL600.115	JL600.024	JL600.048
电压/频率 Voltage/frequency	230V/50/60Hz(AC)	115V/50/60Hz(AC)	24V(DC)	48V(DC)
过滤垫*Filter mat	150 g/m ²	150 g/m ²	150 g/m ²	150 g/m ²
气流风量 Airflow/blast volume	755/830m ³ /h			
最大静压(风量 = 0 m ³ /h) Max. static pressure (blast volume=0m ³ /h)	192 Pa			
过滤效率 Filtration efficiency	73%			
过滤垫等级 Filter mat grade(DIN EN 779)	G 2			
噪音 Noise (DIN 45 635)	72 dB (A)			
负载率 Load rate	100%			
使用温度 The use of temperature	-30℃~+70℃			
储藏温度 Storage temperature	-40℃~+80℃			

气流参数 Airflow parameter	JL902.230	JL902.115	JL902.024	JL902.048
电压/频率 Voltage/frequency	230V/50/60Hz(AC)	115V/50/60Hz(AC)	24V(DC)	48V(DC)
过滤垫*Filter mat	150 g/m ²	150 g/m ²	150 g/m ²	150 g/m ²
气流风量 Airflow/blast volume	105/120m ³ /h			
最大静压(风量 = 0 m ³ /h) Max. static pressure (blast volume=0m ³ /h)	61 Pa			
过滤效率 Filtration efficiency	73%			
过滤垫等级 Filter mat grade(DIN EN 779)	G 2			
噪音 Noise (DIN 45 635)	46/49 dB (A)			
负载率 Load rate	100%			
使用温度 The use of temperature	-30℃~+70℃			
储藏温度 Storage temperature	-40℃~+80℃			

机械参数 Mechanic parameter	JL600.230	JL600.115	JL600.024	JL600.048
外形尺寸 mm(高度 × 宽度 × 安装深度) Dimensions (height * width * mounting depth)	322x322x130	322x322x130	322x322x130	
轴承类型 Type of bearing	滚珠轴承 Ball bearing			
安装方向 Mounting direction	任一种, 推荐水平方式 Any direction (horizontal mounting is recommended)			
结构材料 Structure material	阻燃ABS-FR 符合 UL 94 VO Inflaming retarding ABS-FR conforming to the UL 94 VO			
重量 Weight	3.5 kg	3.5 kg	3kg	
安全等级 Security grade	依据 EN 60529 According to the EN 60529			
颜色 Colour	RAL 7035, RAL 7032, 其它颜色可选 and other colours optional			
连接件 Connection	端子板 Terminal board			
已有认证 Certificate	RoHS、UL、EMC、CE、			
防护等级 IP code	IP54			
过滤棉型号和尺寸 Filter cotton types/dimensions	285 × 285 × 10mm			
过滤棉防护等级 Filter cotton protection grade	符合 UL94V0			

机械参数 Mechanic parameter	JL902.230	JL902.115	JL902.024	JL902.048
外形尺寸 mm(高度 × 宽度 × 安装深度) Dimensions (height * width * mounting depth)	150x150x70	150x150x70	150x150x70	
轴承类型 Type of bearing	滚珠轴承 Ball bearing			
安装方向 Mounting direction	任一种, 推荐水平方式 Any direction (horizontal mounting is recommended)			
结构材料 Structure material	阻燃ABS-FR 符合 UL 94 VO Inflaming retarding ABS-FR conforming to the UL 94 VO			
重量 Weight	0.63 kg	0.63 kg	0.42 kg	
安全等级 Security grade	依据 EN 60529 According to the EN 60529			
颜色 Colour	RAL 7035, RAL 7032, 其它颜色可选 and other colours optional			
连接件 Connection	端子板 Terminal board			
已有认证 Certificate	RoHS、UL、EMC、CE、			
防护等级 IP code	IP54			
过滤棉型号和尺寸 Filter cotton types/dimensions	116 × 116 × 10mm			
过滤棉防护等级 Filter cotton protection grade	符合 UL94V0			

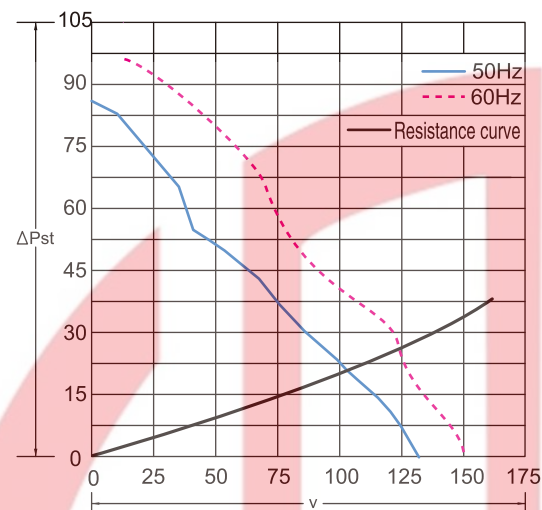
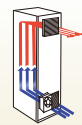

V=容积电流 Volume of current (m³/h)
ΔPst=静止压差 Static pressure difference (Pa)

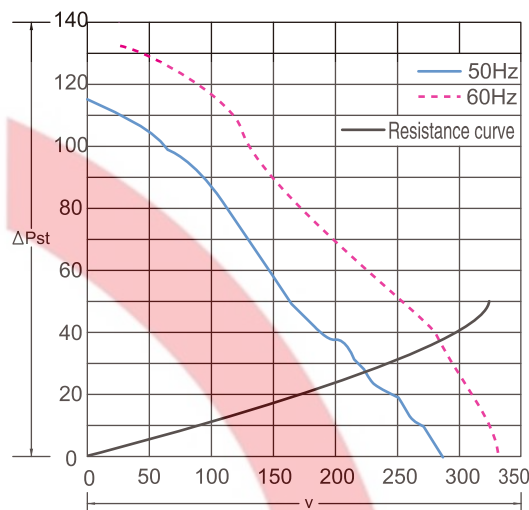

V=容积电流 Volume of current (m³/h)
ΔPst=静止压差 Static pressure difference (Pa)

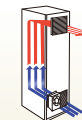

风扇及过滤器 Fan and filter
JL903

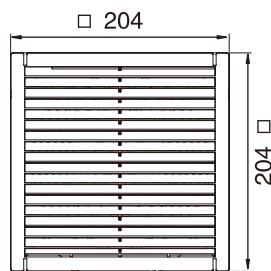

风扇及过滤器 Fan and filter
JL903.230

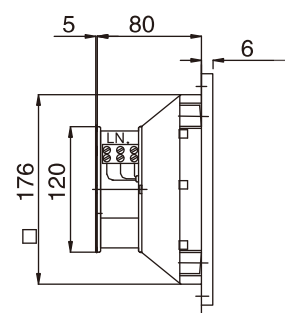

出口过滤器 Outlet filter
JL903.200

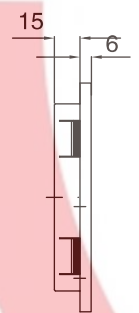

安装剖面 Mounting profile
JL903

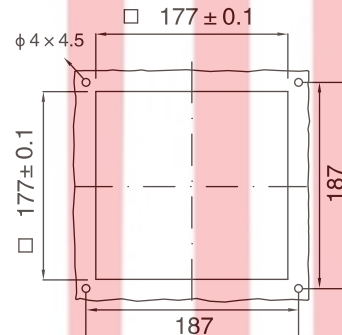

气流参数 Airflow parameter	JL903.230	JL903.115	JL903.024	JL903.048
电压/频率 Voltage/frequency	230V/50/60Hz(AC)	115V/50/60Hz(AC)	24V(DC)	48V(DC)
过滤垫*Filter mat	150 g/m ²	150 g/m ²	150 g/m ²	150 g/m ²
气流风量 Airflow/blast volume		105/120m ³ /h		
最大静压(风量 = 0 m ³ /h) Max. static pressure (blast volume=0m ³ /h)		86 Pa		
过滤效率 Filtration efficiency		73%		
过滤垫等级 Filter mat grade(DIN EN 779)		G 2		
噪音 Noise (DIN 45 635)		46/49 dB (A)		
负载率 Load rate		100%		
使用温度 The use of temperature		-30℃~+70℃		
储藏温度 Storage temperature		-40℃~+80℃		

机械参数 Mechanic parameter	JL903.230	JL903.115	JL903.024	JL903.048
外形尺寸 mm(高度 × 宽度 × 安装深度) Dimensions (height * width * mounting depth)	204x204x85	204x204x85	204x204x85	
轴承类型 Type of bearing	滚珠轴承 Ball bearing			
安装方向 Mounting direction	任一种, 推荐水平方式 Any direction (horizontal mounting is recommended)			
结构材料 Structure material	阻燃ABS-FR 符合 UL 94 VO Inflaming retarding ABS-FR conforming to the UL 94 VO			
重量 Weight	0.77 kg	0.77 kg	0.56 kg	
安全等级 Security grade	依据 EN 60529 According to the EN 60529			
颜色 Colour	RAL 7035, RAL 7032, 其它颜色可选 and other colours optional			
连接件 Connection	端子板 Terminal board			
已有认证 Certificate	RoHS、UL、EMC、CE、			
防护等级 IP code	IP54			
过滤棉型号和尺寸 Filter cotton types/dimensions	170 × 170 × 10mm			
过滤棉防护等级 Filter cotton protection grade	符合 UL94V0			

风扇及过滤器 Fan and filter
JL904

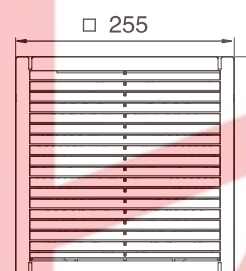

风扇及过滤器 Fan and filter
JL904.230

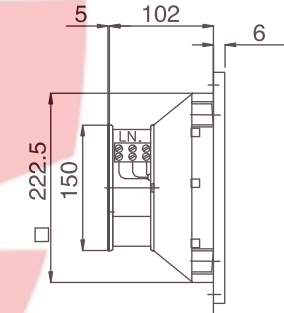

出口过滤器 Outlet filter
JL904.200

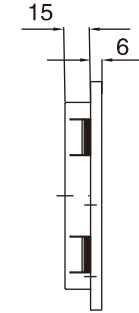

安装剖面 Mounting profile
JL904

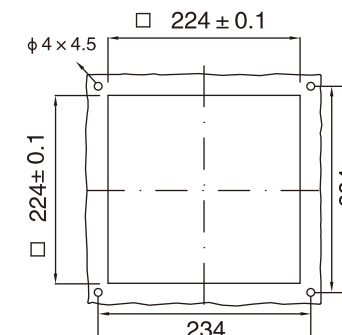

气流参数 Airflow parameter	JL904.230	JL904.115	JL904.024	JL904.048
电压/频率 Voltage/frequency	230V/50/60Hz(AC)	115V/50/60Hz(AC)	24V(DC)	48V(DC)
过滤垫*Filter mat	150 g/m ²	150 g/m ²	150 g/m ²	150 g/m ²
气流风量 Airflow/blast volume		230/265m ³ /h		
最大静压(风量 = 0 m ³ /h) Max. static pressure (blast volume=0m ³ /h)		115 Pa		
过滤效率 Filtration efficiency		73%		
过滤垫等级 Filter mat grade(DIN EN 779)		G 2		
噪音 Noise (DIN 45 635)		54/56 dB (A)		
负载率 Load rate		100%		
使用温度 The use of temperature		-30℃~+70℃		
储藏温度 Storage temperature		-40℃~+80℃		

机械参数 Mechanic parameter	JL904.230	JL904.115	JL904.024	JL904.048
外形尺寸 mm(高度 × 宽度 × 安装深度) Dimensions (height * width * mounting depth)	255x255x107	255x255x107	255x255x107	
轴承类型 Type of bearing	滚珠轴承 Ball bearing			
安装方向 Mounting direction	任一种, 推荐水平方式 Any direction (horizontal mounting is recommended)			
结构材料 Structure material	阻燃ABS-FR 符合 UL 94 VO Inflaming retarding ABS-FR conforming to the UL 94 VO			
重量 Weight	1.5 kg	1.5 kg	1.2 kg	
安全等级 Security grade	依据 EN 60529 According to the EN 60529			
颜色 Colour	RAL 7035, RAL 7032, 其它颜色可选 and other colours optional			
连接件 Connection	端子板 Terminal board			
已有认证 Certificate	RoHS、UL、EMC、CE、			
防护等级 IP code	IP54			
过滤棉型号和尺寸 Filter cotton types/dimensions	87 × 87 × 3mm			
过滤棉防护等级 Filter cotton protection grade	符合 UL94V0			

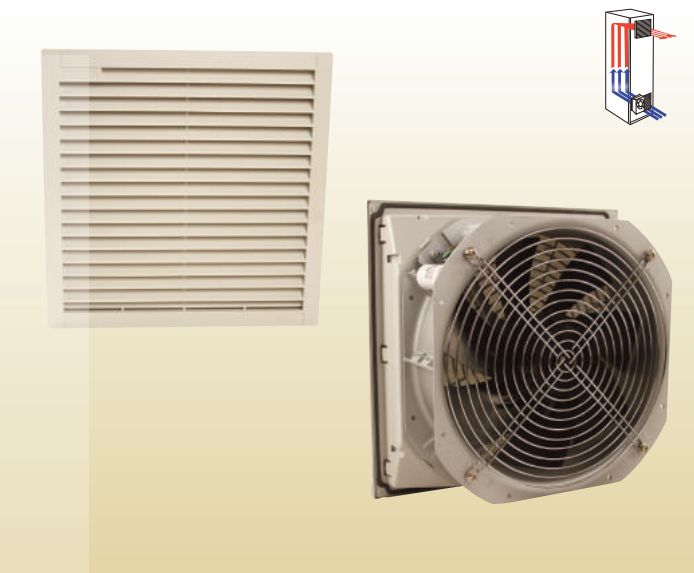
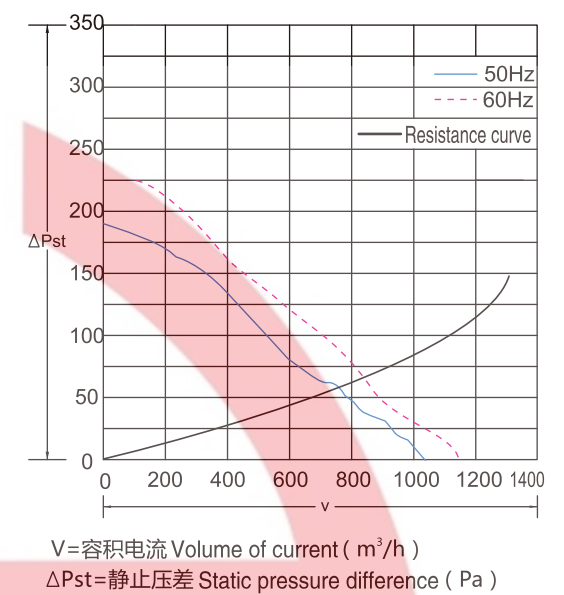
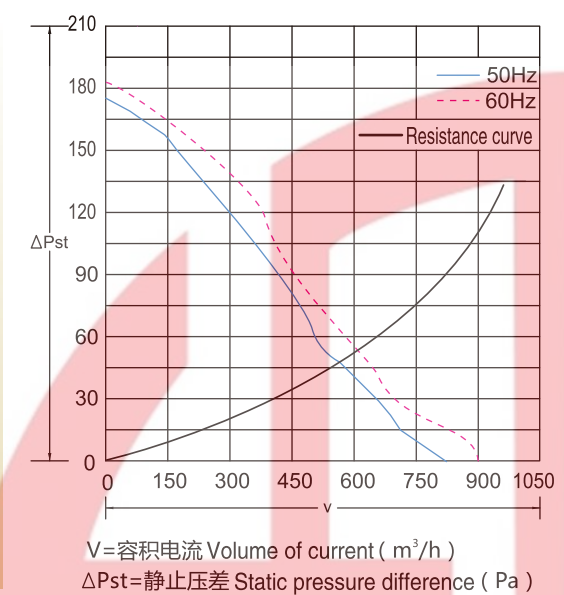

风扇及过滤器 Fan and filter
JL905

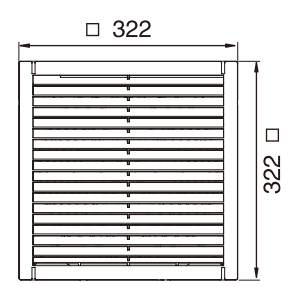

风扇及过滤器 Fan and filter
JL905.230

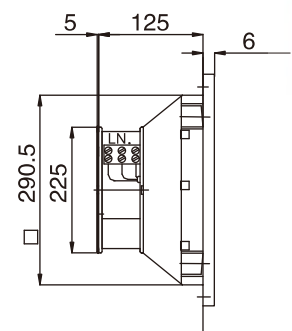

出口过滤器 Outlet filter
JL905.200

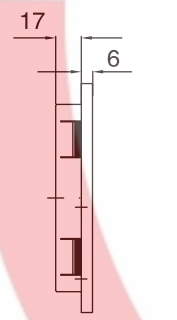

安装剖面 Mounting profile
JL905

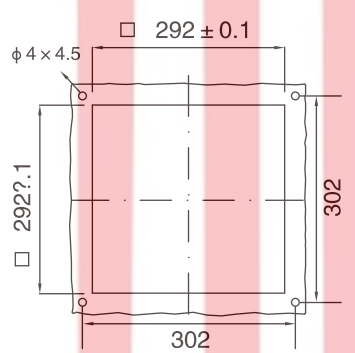

风扇及过滤器 Fan and filter
JL906

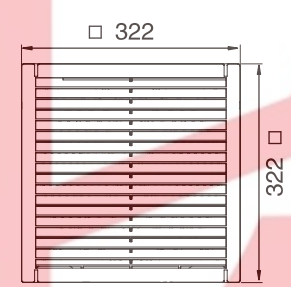

风扇及过滤器 Fan and filter
JL906.230

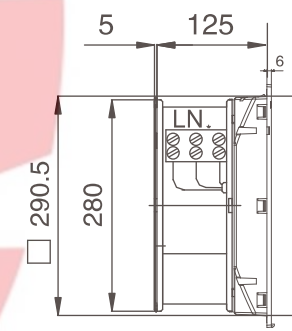

出口过滤器 Outlet filter
JL906.200

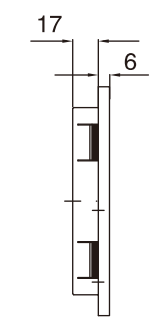

安装剖面 Mounting profile
JL906

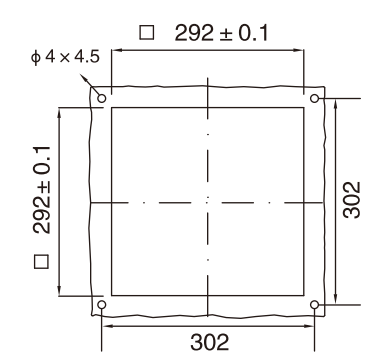

气流参数 Airflow parameter	JL905.230	JL905.115	JL905.024	JL905.048
电压/频率 Voltage/frequency	230V/50/60Hz(AC)	115V/50/60Hz(AC)	24V(DC)	48V(DC)
过滤垫*Filter mat	150 g/m ²	150 g/m ²	150 g/m ²	150 g/m ²
气流风量 Airflow/blast volume	550/600m ³ /h			
最大静压(风量 = 0 m ³ /h) Max. static pressure (blast volume=0m ³ /h)	176 Pa			
过滤效率 Filtration efficiency	73%			
过滤垫等级 Filter mat grade(DIN EN 779)	G 2			
噪音 Noise (DIN 45 635)	59/61 dB (A)			
负载率 Load rate	100%			
使用温度 The use of temperature	-30℃~+70℃			
储藏温度 Storage temperature	-40℃~+80℃			

气流参数 Airflow parameter	JL906.230	JL906.115	JL906.024	JL906.048
电压/频率 Voltage/frequency	230V/50/60Hz(AC)	115V/50/60Hz(AC)	24V(DC)	48V(DC)
过滤垫*Filter mat	150 g/m ²	150 g/m ²	150 g/m ²	150 g/m ²
气流风量 Airflow/blast volume	755/830m ³ /h			
最大静压(风量 = 0 m ³ /h) Max. static pressure (blast volume=0m ³ /h)	192 Pa			
过滤效率 Filtration efficiency	73%			
过滤垫等级 Filter mat grade(DIN EN 779)	G 2			
噪音 Noise (DIN 45 635)	72 dB (A)			
负载率 Load rate	100%			
使用温度 The use of temperature	-30℃~+70℃			
储藏温度 Storage temperature	-40℃~+80℃			

机械参数 Mechanic parameter	JL905.230	JL905.115	JL905.024	JL905.048
外形尺寸 mm(高度 × 宽度 × 安装深度) Dimensions (height * width * mounting depth)	322x322x130	322x322x130	322x322x130	
轴承类型 Type of bearing	滚珠轴承 Ball bearing			
安装方向 Mounting direction	任一种, 推荐水平方式 Any direction (horizontal mounting is recommended)			
结构材料 Structure material	阻燃ABS-FR 符合 UL 94 VO Inflaming retarding ABS-FR conforming to the UL 94 VO			
重量 Weight	2.8 kg	2.8 kg	2.3 kg	
安全等级 Security grade	依据 EN 60529 According to the EN 60529			
颜色 Colour	RAL 7035, RAL 7032, 其它颜色可选 and other colours optional			
连接件 Connection	端子板 Terminal board			
已有认证 Certificate	RoHS、UL、EMC、CE、			
防护等级 IP code	IP54			
过滤棉型号和尺寸 Filter cotton types/dimensions	87 × 87 × 3mm			
过滤棉防护等级 Filter cotton protection grade	符合 UL94V0			

机械参数 Mechanic parameter	JL906.230	JL906.115	JL906.024	JL906.048
外形尺寸 mm(高度 × 宽度 × 安装深度) Dimensions (height * width * mounting depth)	322x322x130	322x322x130	322x322x130	
轴承类型 Type of bearing	滚珠轴承 Ball bearing			
安装方向 Mounting direction	任一种, 推荐水平方式 Any direction (horizontal mounting is recommended)			
结构材料 Structure material	阻燃ABS-FR 符合 UL 94 VO Inflaming retarding ABS-FR conforming to the UL 94 VO			
重量 Weight	3.6 kg	3.6 kg	3.1 kg	
安全等级 Security grade	依据 EN 60529 According to the EN 60529			
颜色 Colour	RAL 7035, RAL 7032, 其它颜色可选 and other colours optional			
连接件 Connection	端子板 Terminal board			
已有认证 Certificate	RoHS、UL、EMC、CE、			
防护等级 IP code	IP54			
过滤棉型号和尺寸 Filter cotton types/dimensions	220 × 220 × 10mm			
过滤棉防护等级 Filter cotton protection grade	符合 UL94V0			

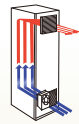

风扇及过滤器 Fan and filter JL9800 出口过滤器 Outlet filter JL9800.200

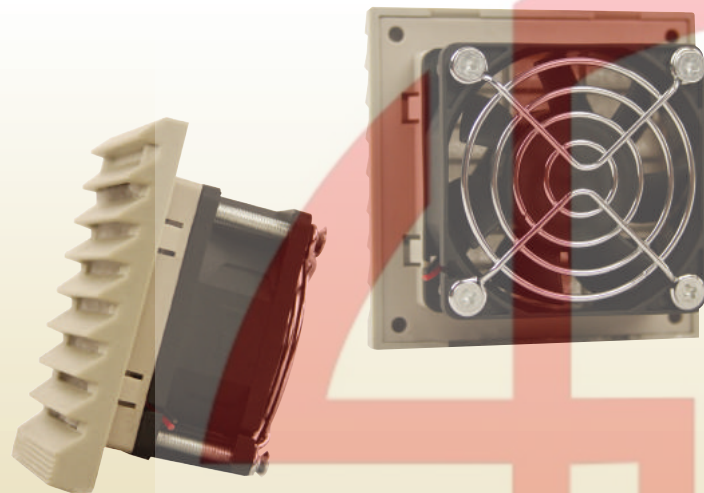
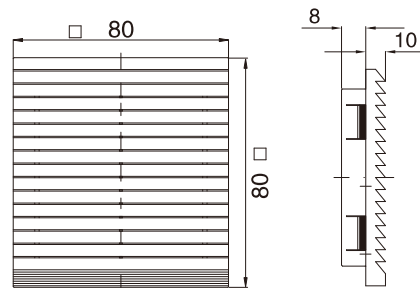

风扇及过滤器 Fan and filter JL9800.230

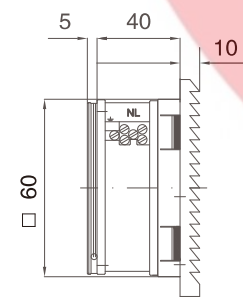

安装剖面 Mounting profile JL9800

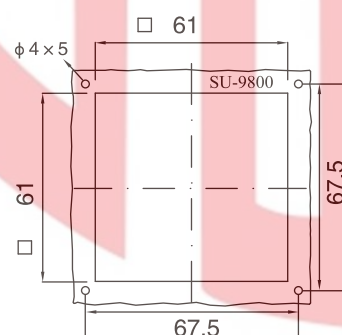

安装方法 Mounting method

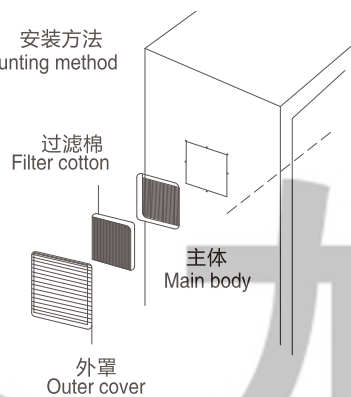

风机及过滤器 型号 JL Fan and filter Model JL	9800.230	9800.115
设计工作电压 (V/Hz) Designed operating voltage	230,50/60	115,50/60
空气流量, 自由吹风 Airflow, free wind	0.3/0.35 m³/h (配 JL6030HA2 使用时)	

除尘率 Dust removal rate	86%
轴流风扇 Axial fan	自启动屏蔽磁极电动机 Automatically started shaded pole motor
设计电流 (A) Electric current designed (A)	0.06/0.05 0.12/0.10
功率 (W) Power (W)	6/5
噪声水平 dB(A) Noise level dB (A)	28/30
工作环境温度 Operating ambient temperature	-10°C 至 +55°C
颜色 Colour	RAL7035
防护等级 IP code	用标准过滤垫为 IP44 IP 44 while using standard filter mat
出口过滤器 型号 JL Outlet filter Model JL	9800.200

配套风扇 Supporting fan 适用于 JL6030 使用 Applicable to JL6030HA2
订购颜色为 RAL7032 或其他色标形式时，请咨询。如需特殊电压也可根据询价提供，本公司保留技术改动权利。
Please consult with us when the colour ordered is RAL 7032 or others. Special voltage may be provided if necessary according to the inquiry. Jiulong all technical modification rights reserved.

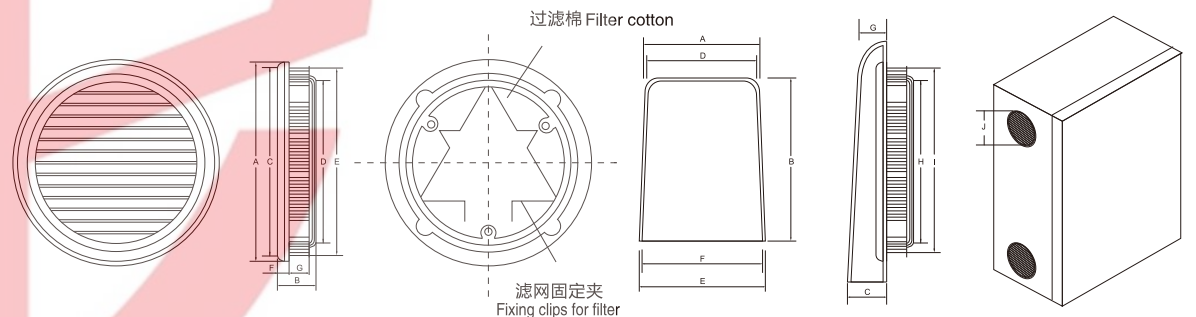

品名 Name	型号 Model	有效风量 Effective volume of wind	除尘率 Dust removal rate	工作环境温度 Operating ambient temperature	颜色 Colour	防护等级 IP code
过滤器 Filter	JL 9801A	20/35 m³/h	80%	-10°C 至 +55°C	RAL7035	IP44
带防雨罩 Conveyor cover	JL 9801B			-10°C 至 +55°C	RAL7035	IP54
风扇及过滤器 Fan and filter	JL 9801C	20/35 m³/h	80%	-10°C 至 +55°C	RAL7035	IP44

尺寸说明表 List of Dimensions

型号 Model	尺寸 (mm) Size (mm)									
	A	B	C	D	E	F	G	H	I	J
JL9801A	105	22.5	101	88.8	97	6	10			90
JL9801B	110	130	50	100	110	120	30	88.8	97	90

品名 Name	型号 Model	有效风量 Effective volume of wind	除尘率 Dust removal rate	工作环境温度 Operating ambient temperature	颜色 Colour	防护等级 IP code
过滤器 Filter	JL 9802A	20/35 m³/h	80%	-10°C 至 +55°C	RAL7035	IP44
带防雨罩 Conveyor cover	JL 9802B			-10°C 至 +55°C	RAL7035	IP54
风扇及过滤器 Fan and filter	JL 9802C	20/35 m³/h	80%	-10°C 至 +55°C	RAL7035	IP44

尺寸说明表 List of Dimensions

型号 Model	尺寸 (mm) Size (mm)									
	A	B	C	D	E	F	G	H	I	J
JL9802A	120	22.5	101	88.8	97	6	10			102
JL9802B	125	140	50	115	125	135	30	100.8	109	102



JIULONG MOTOR
AC/DC FANS COOLING FANS



本样图仅供参考，具体以实物为准。
This sample book is for reference only. Please refer to the specification for details.
如需特殊电压也可根据询价提供。本公司保留技术改动权利。
Special voltage may be provided necessary according to the inquiry. All technical modification rights reserved.

Http://www.xtgygs.cn

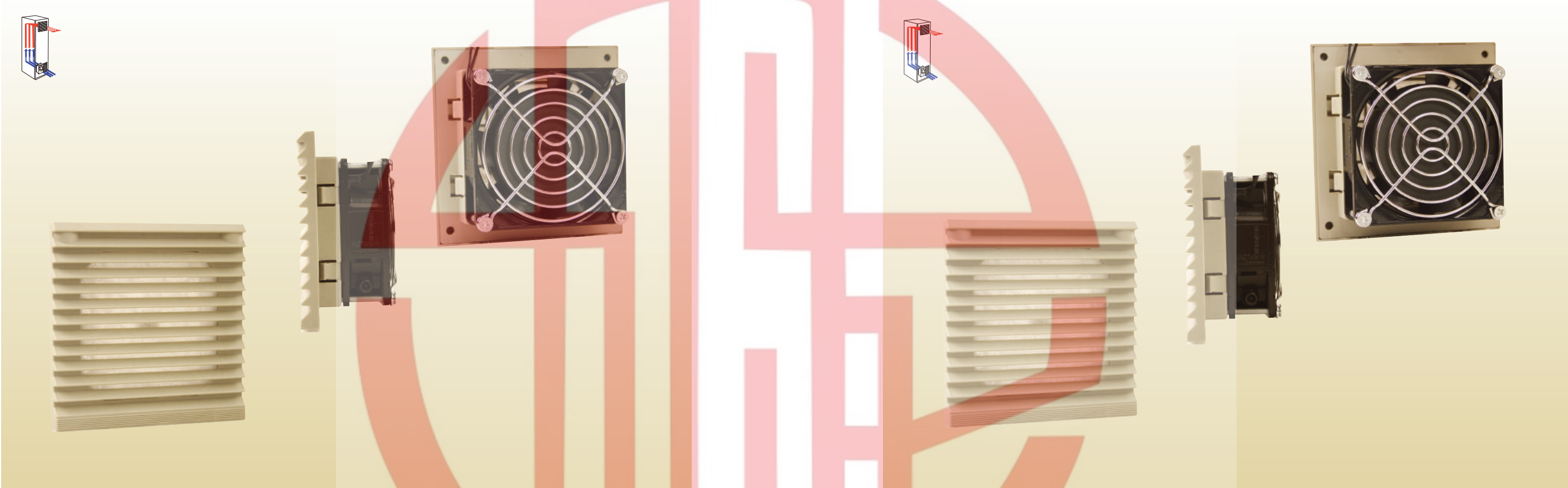

风扇及过滤器 Fan and filter
JL9801

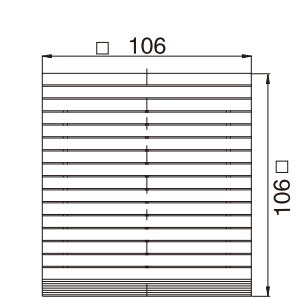

出口过滤器 Outlet filter
JL9801.200

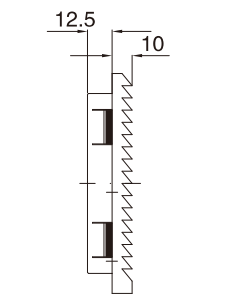

风扇及过滤器 Fan and filter
JL9801.230

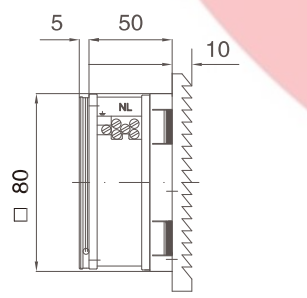

安装剖面 Mounting profile
JL9801

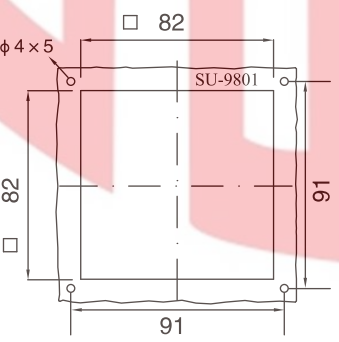

风扇及过滤器 Fan and filter
JL9802

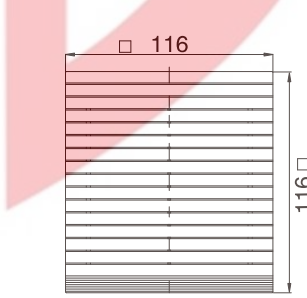

出口过滤器 Outlet filter
JL9802.200

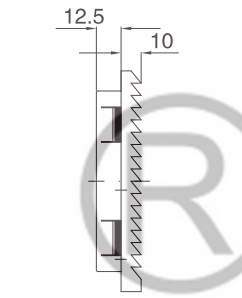

风扇及过滤器 Fan and filter
JL9802.230

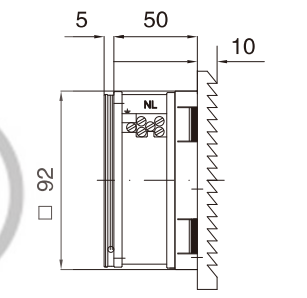

安装剖面 Mounting profile
JL9802

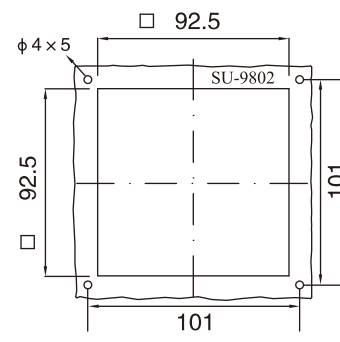

风机及过滤器 型号 JL Fan and filter Model JL	9801.230	9801.115	9801.024
设计工作电压(V/Hz) Designed operating voltage	230,50/60	115,50/60	24
空气流量, 自由吹风 Airflow, free wind	0.5/0.6m³/h (配JL8038HA2 使用时)		

除尘率 Dust removal rate	86%		
轴流风扇 Axial fan	自启动屏蔽磁极电动机 Automatically started shaded pole motor	直流电机 DC motor	
设计电流 (A) Electric current designed (A)	0.08/0.07	0.16/0.14	0.27
功率 (W) Power (W)	13/11		6.4
噪音水平 dB(A) Noise level dB (A)	36/38		
工作环境温度 Operating ambient temperature	-10° C 至 +55° C		
颜色 Colour	RAL7035		
防护等级 IP code	用标准过滤垫为IP44 IP 44 while using standard filter mat		
出口过滤器 型号 JL Outlet filter Model JL	9801.200		
配套风扇 Supporting fan	适用于 JL8038HA2 使用 Applicable to JL8038HA2		

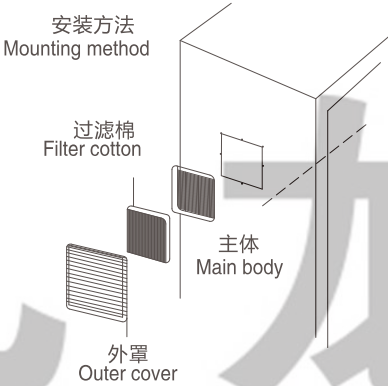

风机及过滤器 型号 SU Fan and filter Model SU	9802.230	9802.115	9802.024
设计工作电压(V/Hz) Designed operating voltage	230,50/60	115,50/60	24
空气流量, 自由吹风 Airflow, free wind	1.2/1.5 m³/h (配 JL9238HA2 使用时)		

除尘率 Dust removal rate	86%		
轴流风扇 Axial fan	自启动屏蔽磁极电动机 Automatically started shaded pole motor	直流电机 DC motor	
设计电流 (A) Electric current designed (A)	0.07/0.06	0.12/0.15	0.38
功率 (W) Power (W)	16/17		9.1
噪音水平 dB(A) Noise level dB (A)	29/30		
工作环境温度 Operating ambient temperature	-10° C 至 +55° C		
颜色 Colour	RAL7035		
防护等级 IP code	用标准过滤垫为IP44 IP 44 while using standard filter mat		
出口过滤器 型号 SU Outlet filter Model SU	9802.200		
配套风扇 Supporting fan	适用于 JL9238HA2 使用 Applicable to JL9238HA2		

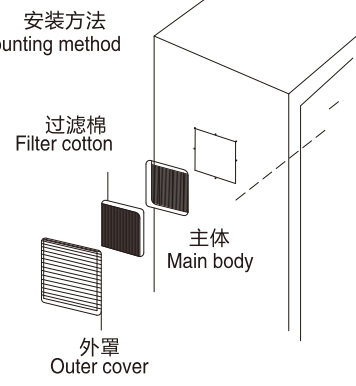

订购颜色为RAL7032或其他色标形式时, 请洽询。如需特殊电压也可根据询价提供, 本公司保留技术改动权利。
Please consult with us when the colour ordered is RAL 7032 or others. Special voltage may be provided if necessary according to the inquiry. Jiulong all technical modification rights reserved.

订购颜色为RAL7032或其他色标形式时, 请洽询。如需特殊电压也可根据询价提供, 本公司保留技术改动权利。
Please consult with us when the colour ordered is RAL 7032 or others. Special voltage may be provided if necessary according to the inquiry. Jiulong all technical modification rights reserved.

AC Axial Fan
AC轴流风机

AC All-Metal Axial Fan
AC全金属轴流风扇

DC Axial Fan
DC轴流风机

DC Centrifugal Fan
DC离心风机

EC Axial Fan
EC轴流风机

EC Centrifugal Fan
EC离心风机

AC Centrifugal Fan
AC离心风机

Fan Accessories
风机配件



JIULONG MOTOR
AC/DC FANS COOLING FANS



本样图仅供参考，具体以规格书为准。
This sample book is for reference only. Please refer to the specification for details.
如需特殊电压也可根据询价提供。本公司保留技术改动权利。
Special voltage may be provided according to the inquiry. Jiulong all technical modification rights reserved.

Http://www.xtgygs.cn

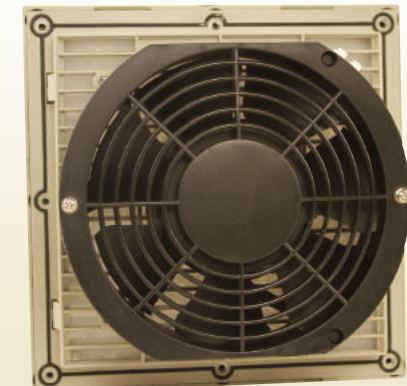
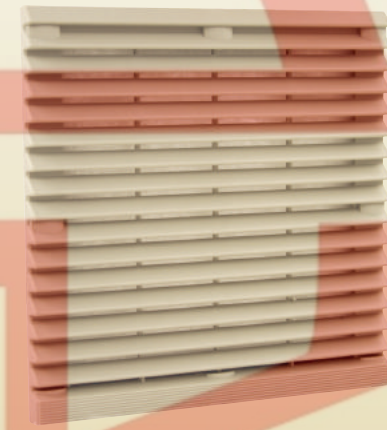
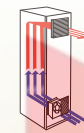
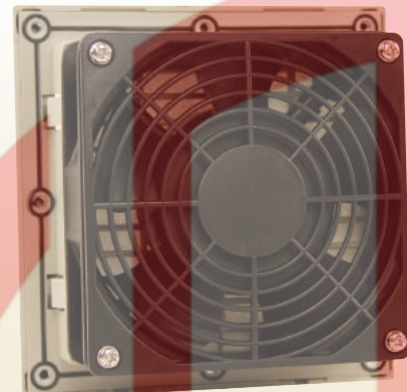
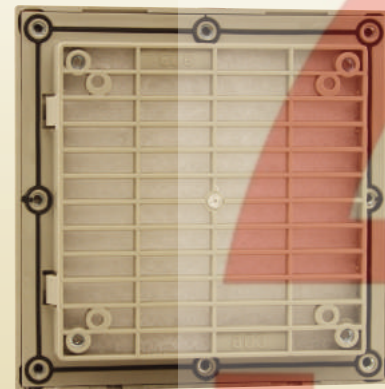
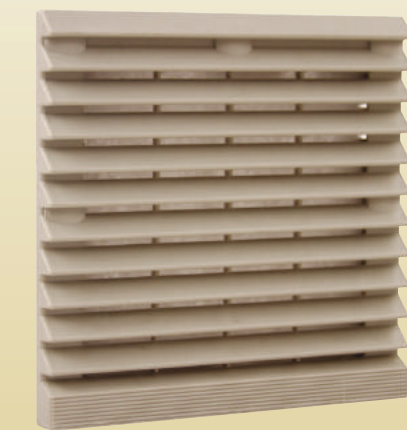
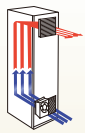

风扇及过滤器 Fan and filter
JL9803

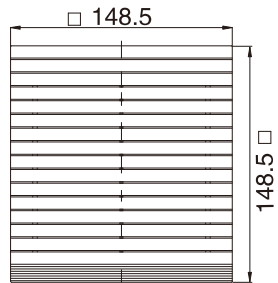

出口过滤器 Outlet filter
JL9803.200

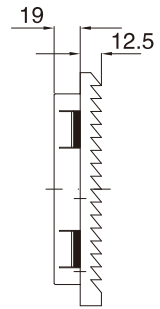

风扇及过滤器 Fan and filter
JL9803.230

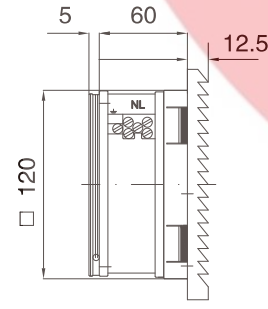

安装剖面 Mounting profile
JL9803

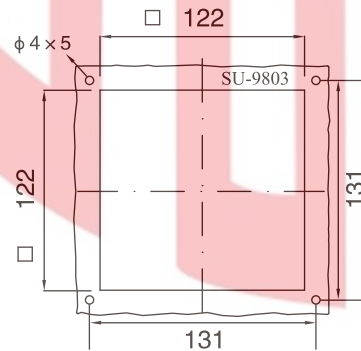

风机及过滤器 型号 JL Fan and filter Model JL	9803.230	9803.115	9803.024
设计工作电压 (V/Hz) Designed operating voltage	230,50/60	115,50/60	24
空气流量, 自由吹风 Airflow, free wind	2.3/2.7 m ³ /h (配 JL12038HA2 使用时)		

除尘率 Dust removal rate	86%		
轴流风扇 Axial fan	自启动屏蔽磁极电动机. Automatically started shaded pole motor 直流电机 DC motor		
设计电流 (A) Electric current designed (A)	0.14/0.13	0.28/0.26	0.22
功率 (W) Power (W)	21/25		5.3
噪音水平 dB(A) Noise level dB (A)	47/49		
工作环境温度 Operating ambient temperature	-10° C 至 +55° C		
颜色 Colour	RAL7035		
防护等级 IP code	用标准过滤垫为 IP44 IP 44 while using standard filter mat		
出口过滤器 型号 JL Outlet filter Model JL	9803.200		
配套风扇 Supporting fan	适用于 (Applicable to) JL12038HA2 使用		

订购颜色为RAL7032或其他色标形式时, 请洽询。如需特殊电压也可根据询价提供, 本公司保留技术改动权利。
Please consult with us when the colour ordered is RAL 7032 or others. Special voltage may be provided if necessary according to the inquiry. Jiulong all technical modification rights reserved.

安装方法
Mounting method

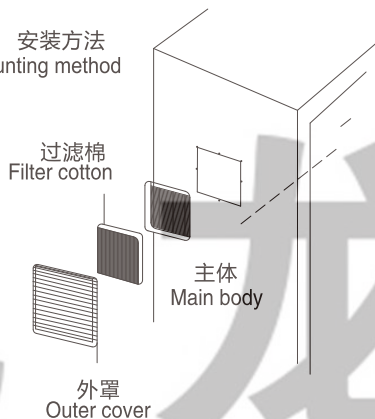

风扇及过滤器 Fan and filter
JL9804

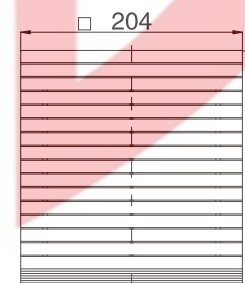

出口过滤器 Outlet filter
JL9804.200

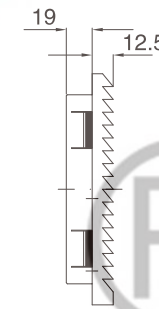

风扇及过滤器 Fan and filter
JL9804.230

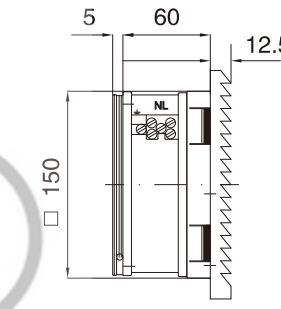

安装剖面 Mounting profile
JL9804

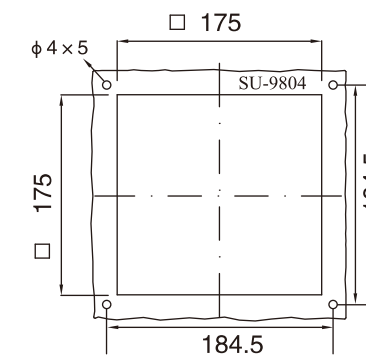

风机及过滤器 型号 JL Fan and filter Model JL	9804.230	9804.115	9804.024
设计工作电压 (V/Hz) Designed operating voltage	230,50/60	115,50/60	24
空气流量, 自由吹风 Airflow, free wind	5 m ³ /h (配 JL17250HA2 使用时)		

除尘率 Dust removal rate	86%		
轴流风扇 Axial fan	自启动屏蔽磁极电动机. Automatically started shaded pole motor 直流电机 DC motor		
设计电流 (A) Electric current designed (A)	0.25	0.5	0.5
功率 (W) Power (W)	38		12
噪音水平 dB(A) Noise level dB (A)	55		
工作环境温度 Operating ambient temperature	-10° C 至 +55° C		
颜色 Colour	RAL7035		
防护等级 IP code	用标准过滤垫为 IP44 IP 44 while using standard filter mat		
出口过滤器 型号 JL Outlet filter Model JL	9804.200		
配套风扇 Supporting fan	适用于 (Applicable to) JL12038HA2 JL17250HA2 JL15050HA2 使用		

订购颜色为RAL7032或其他色标形式时, 请洽询。如需特殊电压也可根据询价提供, 本公司保留技术改动权利。
Please consult with us when the colour ordered is RAL 7032 or others. Special voltage may be provided if necessary according to the inquiry. Jiulong all technical modification rights reserved.

安装方法
Mounting method

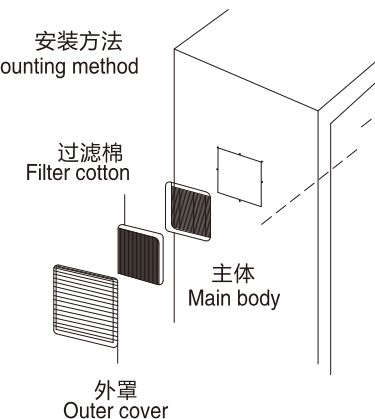

AC Axial Fan
AC轴流风机

AC All-Metal Axial Fan
AC全金属轴流风扇

DC Axial Fan
DC轴流风机

DC Centrifugal Fan
DC离心风机

EC Axial Fan
EC轴流风机

EC Centrifugal Fan
EC离心风机

AC Centrifugal Fan
AC离心风机

Fan Accessories
风机配件



JIULONG MOTOR
AC/DC FANS COOLING FANS



本样图仅供参考，具体以规格书为准。
This sample book is for reference only. Please refer to the specification for details.
如需特殊电压也可根据询价提供，本公司保留技术改动权利。
Special voltage may be provided flexibly according to the inquiry. All technical modification rights reserved.

Http://www.xtgygs.cn

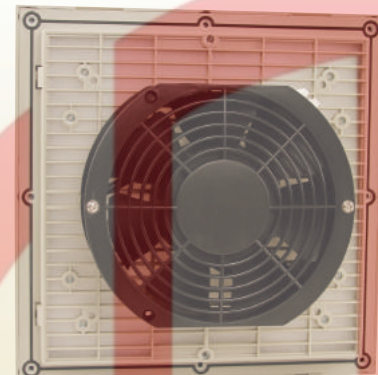
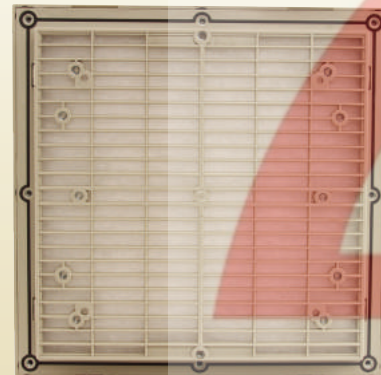
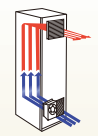

安装剖面 Mounting profile
JL9805

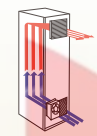

安装剖面 Mounting profile
JL9806

风扇及过滤器 Fan and filter
JL9805

出口过滤器 Outlet filter
JL9805.200

风扇及过滤器 Fan and filter
JL9805.230

安装剖面 Mounting profile
JL9805

风扇及过滤器 Fan and filter
JL9806

出口过滤器 Outlet filter
JL9806.200

风扇及过滤器 Fan and filter
JL9806

安装剖面 Mounting profile
JL9806

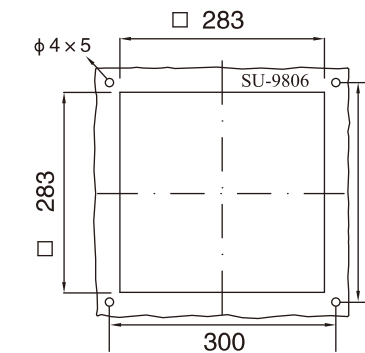
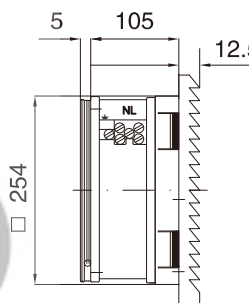
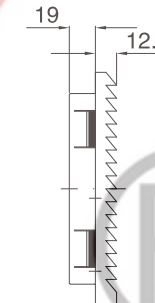
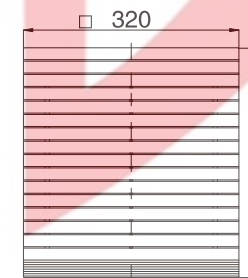
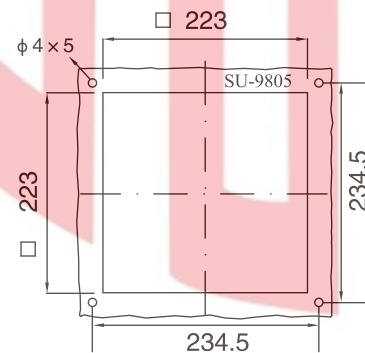
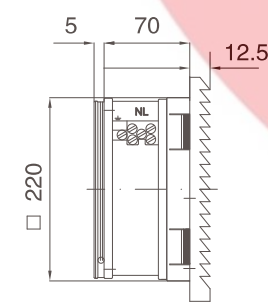
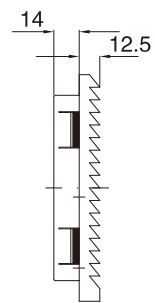
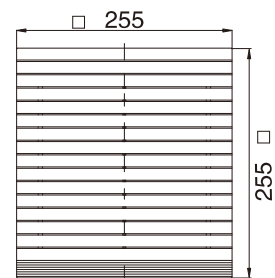

风机及过滤器 型号 JL Fan and filter Model JL	9805.230	9805.115	9805.024
设计工作电压(V/Hz)Designed operating voltage	230,50/60	115,50/60	24
空气流量, 自由吹风 Airflow, free wind	11 m ³ /h (配JL22060HA2 使用时)		

除尘率 Dust removal rate	86%		
轴流风扇 Axial fan	自启动屏蔽磁极电动机. Automatically started shaded pole motor	直流电机 DC motor	
设计电流 (A) Electric current designed (A)	0.35	0.70	1.50
功率 (W) Power (W)	65		36
噪音水平 dB(A) Noise level dB (A)	60		
工作环境温度 Operating ambient temperature	-10° C 至 +55° C		
颜色 Colour	RAL7035		
防护等级 IP code	用标准过滤垫为IP44 IP 44 while using standard filter mat		
出口过滤器 型号 JL Outlet filter Model JL	9805.200		
配套风扇 Supporting fan	适用于 (Applicable to) JL17250HA2 JL18060HA2 JL22060A2 JL20060HA2 使用		

订购颜色为RAL7032或其他色标形式时, 请洽询。如需特殊电压也可根据询价提供, 本公司保留技术改动权利。
Please consult with us when the colour ordered is RAL 7032 or others. Special voltage may be provided if necessary according to the inquiry. Jiulong all technical modification rights reserved.

安装方法
Mounting method

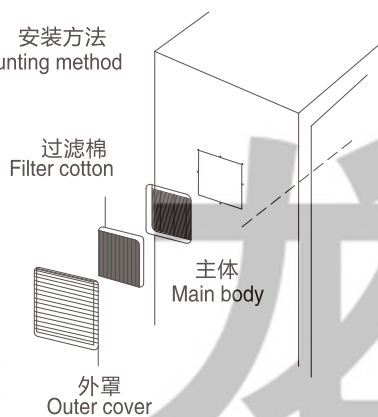

风机及过滤器 型号 JL Fan and filter Model JL	9806.230	9806.115	9806.024
设计工作电压(V/Hz)Designed operating voltage	230,50/60	115,50/60	24
空气流量, 自由吹风 Airflow, free wind	25 m ³ /h (配JL25489HA2 使用时)		

除尘率 Dust removal rate	86%		
轴流风扇 Axial fan	自启动屏蔽磁极电动机. Automatically started shaded pole motor	直流电机 DC motor	
设计电流 (A) Electric current designed (A)	0.45/0.60	1.0/1.1	2.40
功率 (W) Power (W)	70		57.6
噪音水平 dB(A) Noise level dB (A)	68		
工作环境温度 Operating ambient temperature	-10° C 至 +55° C		
颜色 Colour	RAL7035		
防护等级 IP code	用标准过滤垫为IP44 IP 44 while using standard filter mat		
出口过滤器 型号 JL Outlet filter Model JL	9806.200		
配套风扇 Supporting fan	适用于 (Applicable to) JL25489HA2 JL22060HA2 JL2207HB 使用		

订购颜色为RAL7032或其他色标形式时, 请洽询。如需特殊电压也可根据询价提供, 本公司保留技术改动权利。
Please consult with us when the colour ordered is RAL 7032 or others. Special voltage may be provided if necessary according to the inquiry. Jiulong all technical modification rights reserved.

安装方法
Mounting method

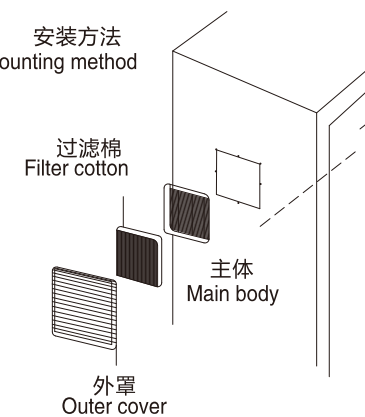

AC Axial Fan
AC轴流风机

AC All-Metal Axial Fan
AC全金属轴流风扇

DC Axial Fan
DC轴流风机

DC Centrifugal Fan
DC离心风机

EC Axial Fan
EC轴流风机

EC Centrifugal Fan
EC离心风机

AC Centrifugal Fan
AC离心风机

Fan Accessories
风机配件



JIULONG MOTOR
AC/DC FANS COOLING FANS



本样机仅做造型参考，具体以规格书为准。
This sample book is for reference only. Please refer to the specification for details.
如需特殊电压也可根据询价提供，本公司保留技术改动权利。
Special voltage may be provided necessary according to the inquiry. Jiulong all technical modification rights reserved.

Http://www.xtgygs.cn

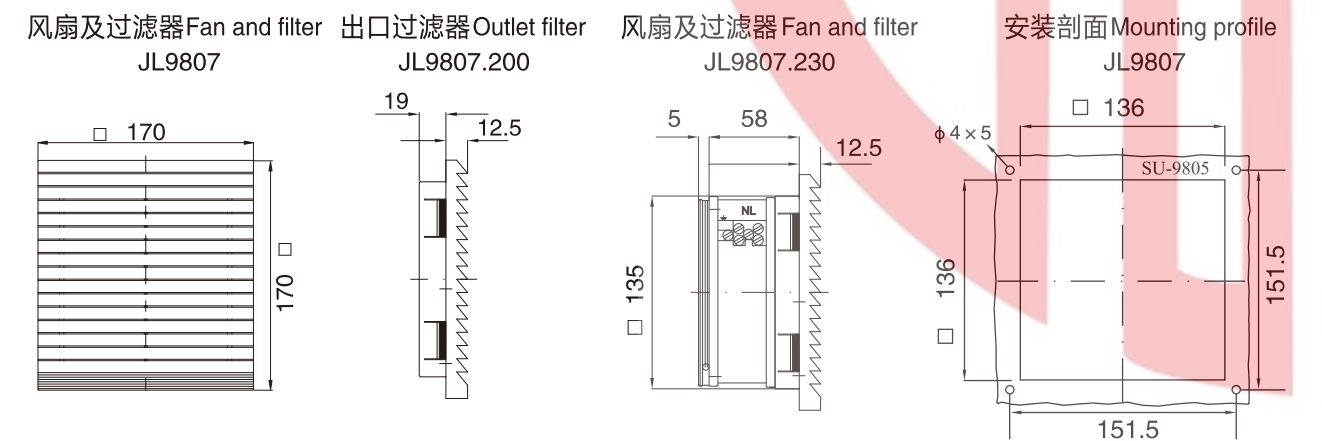
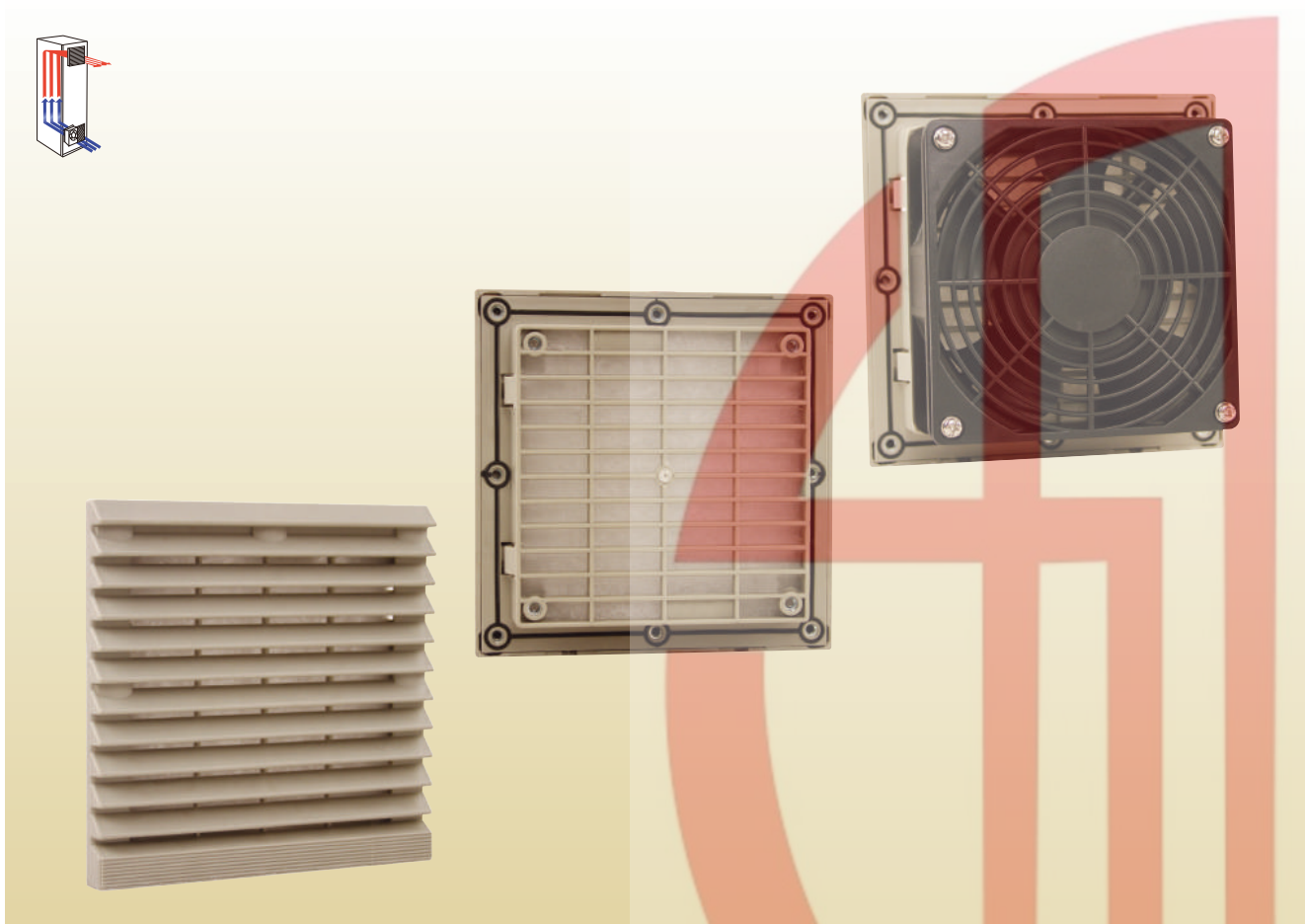

风机及过滤器 型号 JL Fan and filter Model JL	9807.230	9807.115	9807.024
设计工作电压 (V/Hz) Designed operating voltage	230,50/60	115,50/60	24
空气流量, 自由吹风 Airflow, free wind	3.2 m ³ /h (配 JL13538HA2 使用时)		
除尘率 Dust removal rate	86%		
轴流风扇 Axial fan	自启动屏蔽磁极电动机 Automatically started shaded pole motor 直流电机 DC motor		
设计电流 (A) Electric current designed (A)	0.15	0.30	0.28
功率 (W) Power (W)	25		6.7
噪音水平 dB(A) Noise level dB (A)	51		
工作环境温度 Operating ambient temperature	-10° C 至 +55° C		
颜色 Colour	RAL7035		
防护等级 IP code	用标准过滤垫为 IP44 IP 44 while using standard filter mat		
出口过滤器 型号 JL Outlet filter Model JL	9807.200		
配套风扇 Supporting fan	适用于 (Applicable to) JL13538HA2 使用		

订购颜色为RAL7032或其他色标形式时，请洽询。如需特殊电压也可根据询价提供，本公司保留技术改动权利。
Please consult with us when the colour ordered is RAL 7032 or others. Special voltage may be provided if necessary according to the inquiry. Jiulong all technical modification rights reserved.

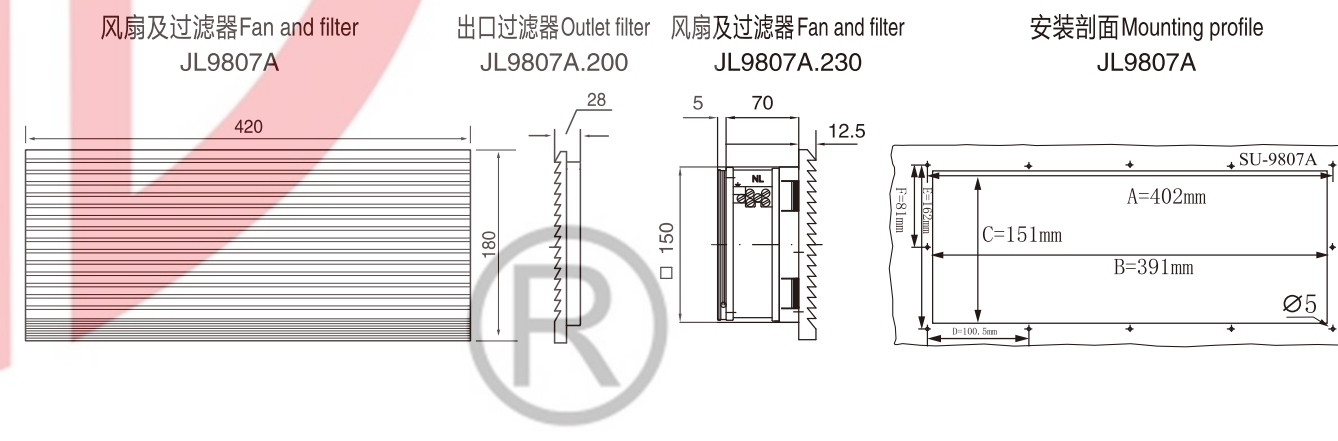

风机及过滤器 型号 JL Fan and filter Model JL	9807A.230	9807A.115	9807A.024
设计工作电压 (V/Hz) Designed operating voltage	230,50/60	115,50/60	24
空气流量, 自由吹风 Airflow, free wind	10 m ³ /h (配 JL17250HA2 使用时)		
除尘率 Dust removal rate	86%		
轴流风扇 Axial fan	自启动屏蔽磁极电动机 Automatically started shaded pole motor 直流电机 DC motor		
设计电流 (A) Electric current designed (A)	0.25	0.5	0.5
功率 (W) Power (W)	35		12
噪音水平 dB(A) Noise level dB (A)	58		
工作环境温度 Operating ambient temperature	-10° C 至 +55° C		
颜色 Colour	RAL7035		
防护等级 IP code	用标准过滤垫为 IP44 IP 44 while using standard filter mat		
出口过滤器 型号 JL Outlet filter Model JL	9807A.200		
配套风扇 Supporting fan	适用于 (Applicable to) JL17250HA2 JL12038HA2 使用		

订购颜色为RAL7032或其他色标形式时，请洽询。如需特殊电压也可根据询价提供，本公司保留技术改动权利。
Please consult with us when the colour ordered is RAL 7032 or others. Special voltage may be provided if necessary according to the inquiry. Jiulong all technical modification rights reserved.

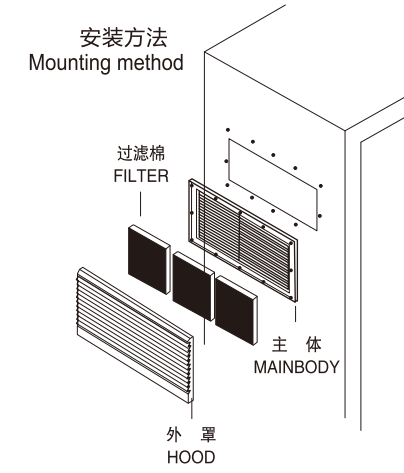
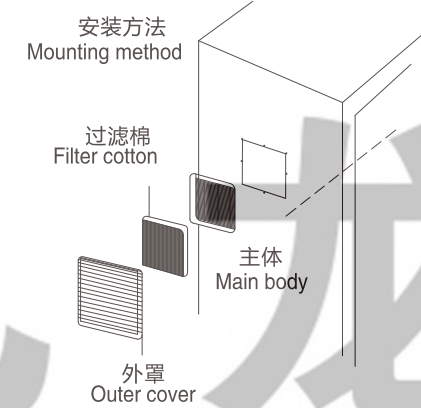

AC Axial Fan
AC轴流风机

AC All-Metal Axial Fan
AC全金属轴流风扇

DC Axial Fan
DC轴流风机

DC Centrifugal Fan
DC离心风机

EC Axial Fan
EC轴流风机

EC Centrifugal Fan
EC离心风机

AC Centrifugal Fan
AC离心风机

Fan Accessories
风机配件



JILONG MOTOR
AC/DC FANS COOLING FANS



本样图仅供参考，具体以实物为准。
This sample book is for reference only, please refer to the specification for details.
如需特殊电压也可根据需求提供，本公司保留技术更改权利。
Special voltage may be provided according to the enquiry, although technical modification is reserved.

Http://www.xtgygs.cn

三合一豪华防尘网罩

Three-in-one luxurious dust-proof mesh cover

通风网本体材质：耐燃级ABS树脂

滤网材质：尼龙纤维合成树脂

使用范围：屋内-10 ~ +55

除尘率：89%

防护等级：IP40

Material of the ventilator: Flame Retardant ABS Resin

Material of filter screen: resin mixed with nylon fiber

Scope: room temperature from -10 to +55

Dust removal rate: 89%

IP code: IP40

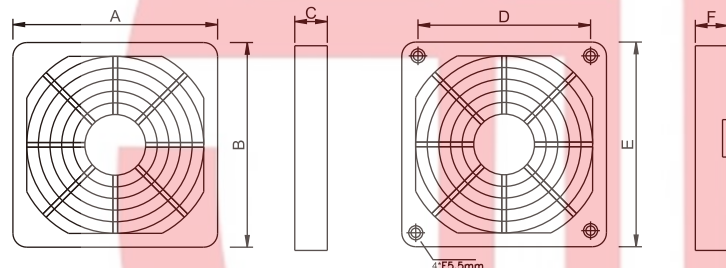

型号 Model	A	B	C	D	E	F
JL-30H(B)	44	44	7	32	40	3

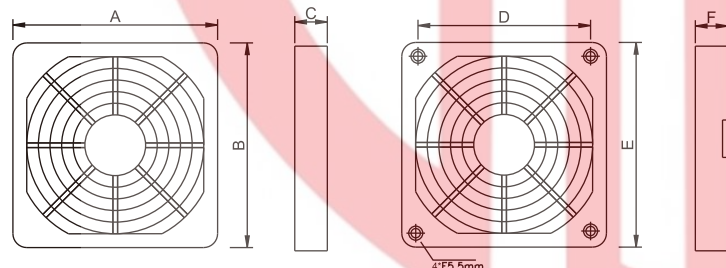

型号 Model	A	B	C	D	E	F
JL-40H(B)	54	54	7	40	50	3

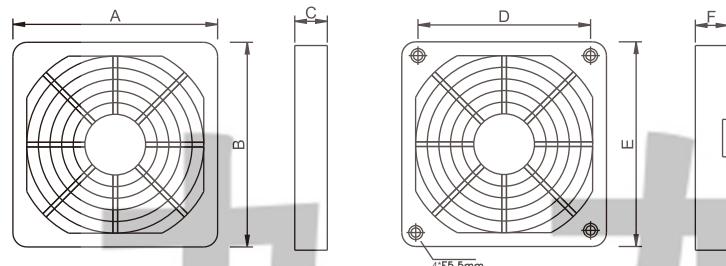

型号 Model	A	B	C	D	E	F
JL-50H(B)-A	64	64	7	50	60	3

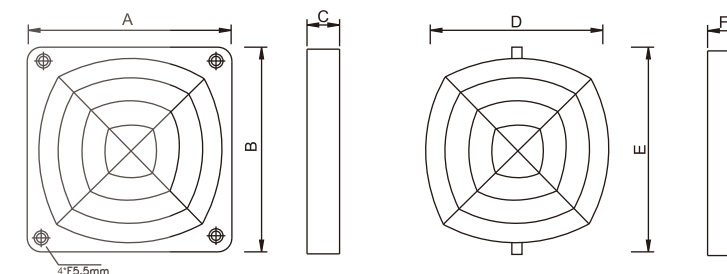
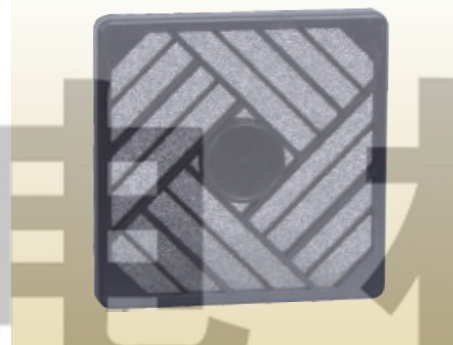

型号 Model	A	B	C	D	E	F
JL-50H(B)-A	60	60	6	50	60	3

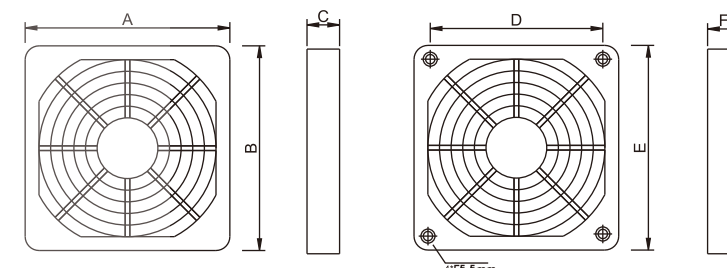

型号 Model	A	B	C	D	E	F
JL-61H(B)	74	74	10	61.5	70	3

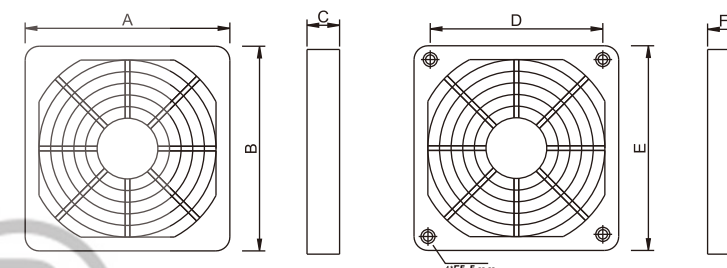

型号 Model	A	B	C	D	E	F
JL-71H(B)-A	87	87	9	71.5	80	4.5

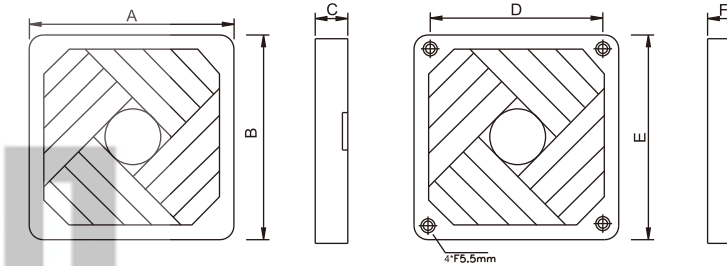

型号 Model	A	B	C	D	E	F
JL-71H(B)-B	85	85	12.5	71.5	80	6.5

AC Axial Fan
AC轴流风机

AC All-Metal Axial Fan
AC全金属轴流风扇

DC Axial Fan
DC轴流风机

DC Centrifugal Fan
DC离心风机

EC Axial Fan
EC轴流风机

EC Centrifugal Fan
EC离心风机

AC Centrifugal Fan
AC离心风机

Fan Accessories
风机配件

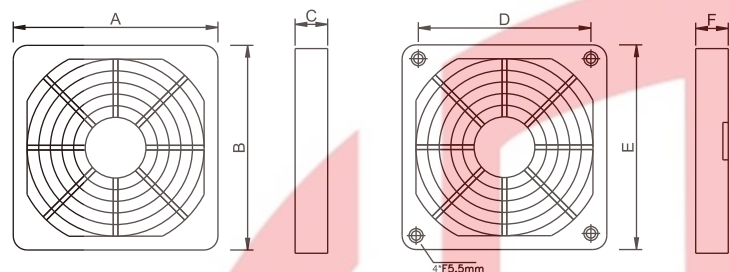

型号 Model	A	B	C	D	E	F
JL-82H(B)	97	97	9	82.5	92	4.5

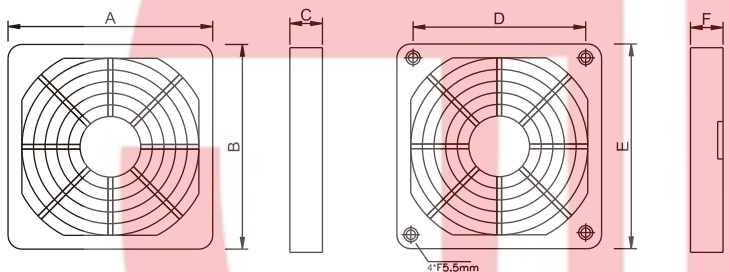

型号 Model	A	B	C	D	E	F
JL-88H(B)	115	115	10	88.3	110	4.5

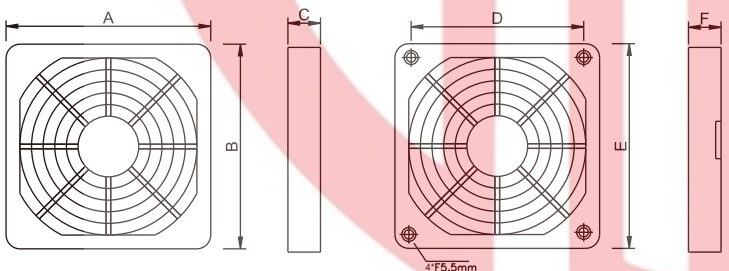

型号 Model	A	B	C	D	E	F
JL-105H(B)-A	125	125	10	105	120	4.5

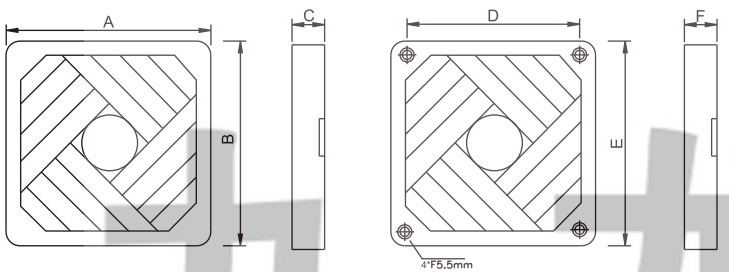

型号 Model	A	B	C	D	E	F
JL-105H(B)-B	125	125	13	105	120	6.5

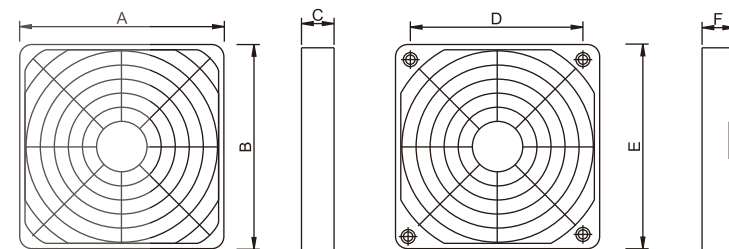
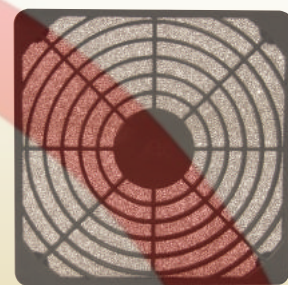

型号 Model	A	B	C	D	E	F
JL-105H(B)-C	125	125	7	105	120	4.5

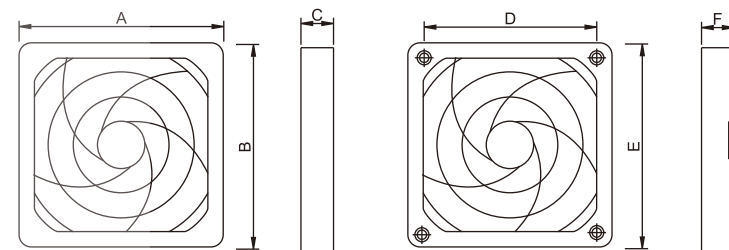

型号 Model	A	B	C	D	E	F
JL-105H(B)-D	125	125	10	105	120	4.5

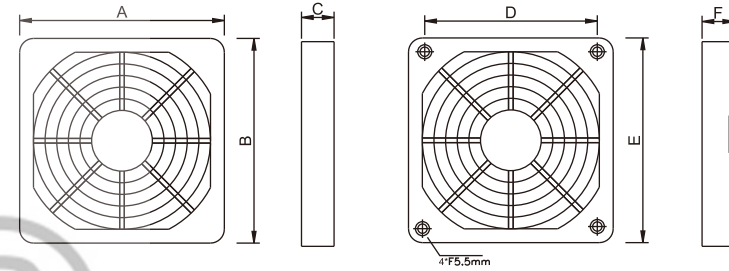
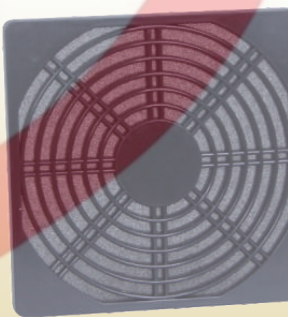

型号 Model	A	B	C	D	E	F
JL-113H(B)	132	132	10	113	127	4.5

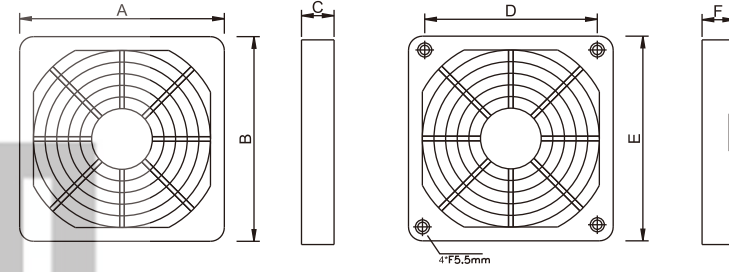
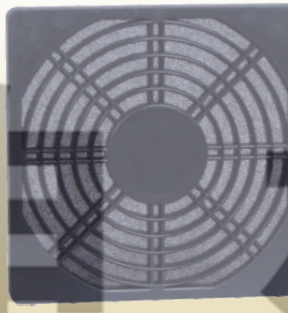

型号 Model	A	B	C	D	E	F
JL-110H(B)	139	139	10	110	135	4.5



JIULONG MOTOR
AC/DC FANS COOLING FANS



本样图仅供参考，具体以实物为准。
This sample book is for reference only. Please refer to the specification for details.
如需特殊电压也可根据需求提供，本公司保留技术更改权利。
Special voltage may be provided according to the requirement, although technical modification rights reserved.

Http://www.xtgygs.cn

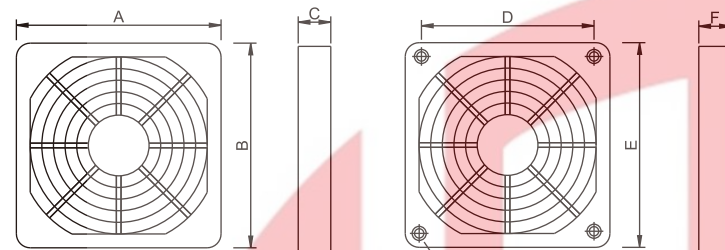

型号 Size Model 尺寸(mm)	A	B	C	D	E	F
JL-122H(B)	155	155	10	122	150	4.5

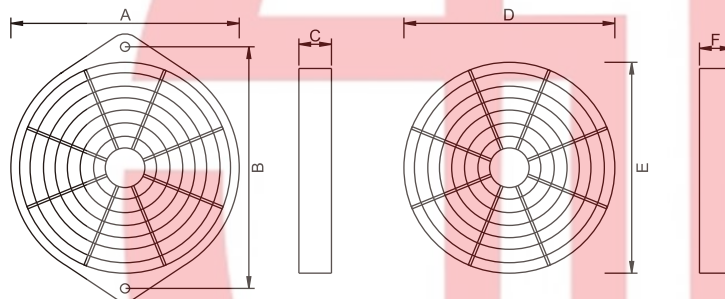

型号 Size Model 尺寸(mm)	A	B	C	D	E	F
JL-150H(B)-B	150	162	7	150	150	4.5

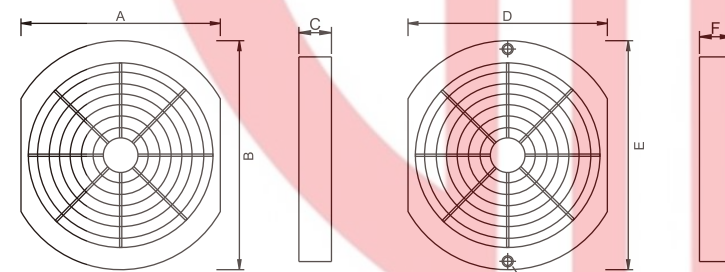

型号 Size Model 尺寸(mm)	A	B	C	D	E	F
JL-162H(B)-Y	155	177	10	150	162	4.5

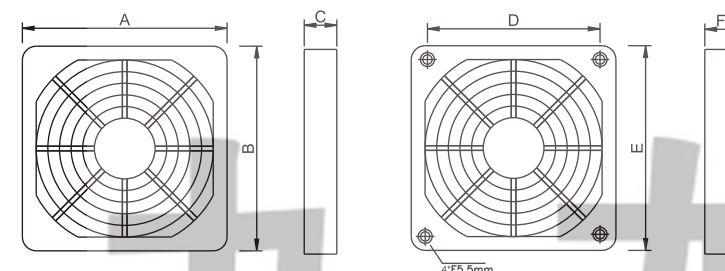

型号 Size Model 尺寸(mm)	A	B	C	D	E	F
JL-166H(B)	206	206	10	166	200	4.5

Plastic Filter Guard

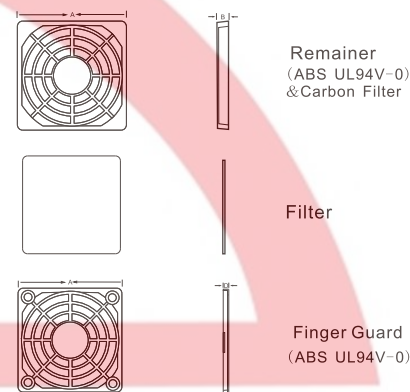

JL-06 For 60mm Fan

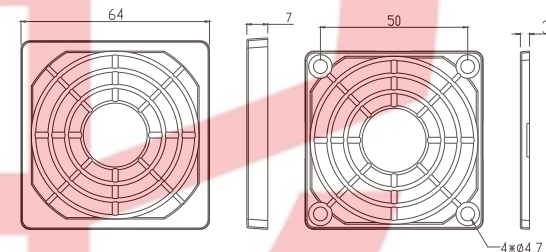

JL-09 For 92mm Fan

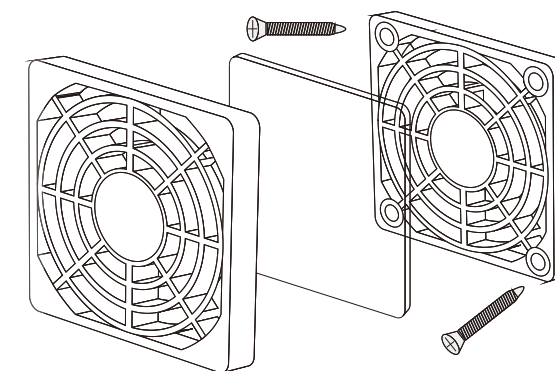
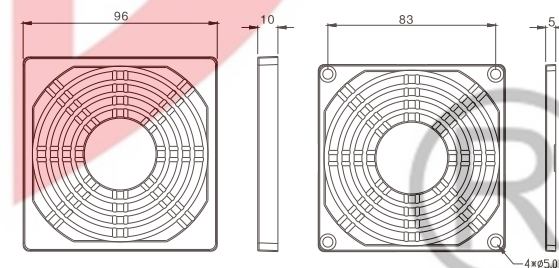

JL-08 For 80mm Fan

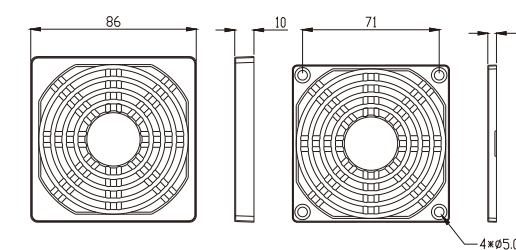

JL-12 For 120mm Fan

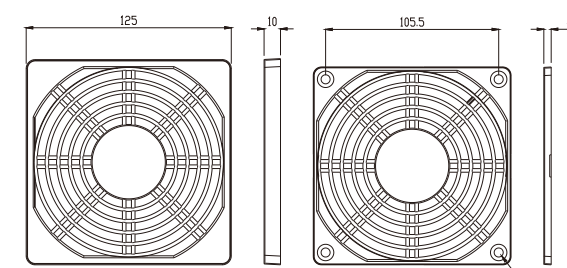

JL-15 For 150mm Fan

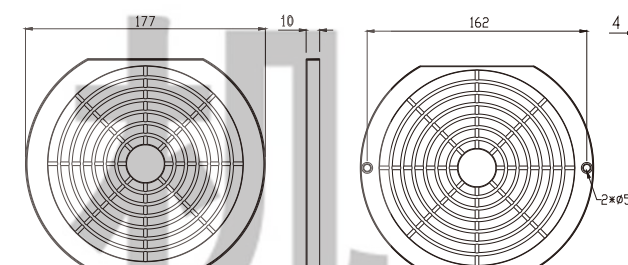

AC Axial Fan
AC轴流风机

AC All-Metal Axial Fan
AC全金属轴流风扇

DC Axial Fan
DC轴流风机

DC Centrifugal Fan
DC离心风机

EC Axial Fan
EC轴流风机

EC Centrifugal Fan
EC离心风机

AC Centrifugal Fan
AC离心风机

Fan Accessories
风机配件



本样图仅供参考，具体以实物为准。
This sample book is for reference only. Please refer to the specification for details.
如需特殊电压也可特别定制提供。本公司保留技术知识产权。
Special voltage may be provided flexibly according to the query. All technical modification rights reserved.

单片防护塑网 SINGLE PROTECTIVE PLASTICS GRID

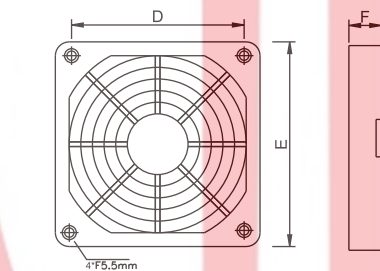
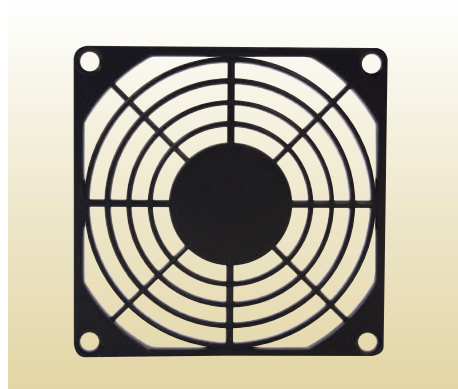
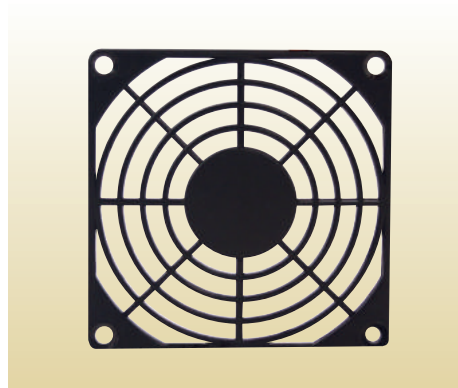

型号 Size Model	D	E	F
JL-80H(B)	71.5	80	3.5

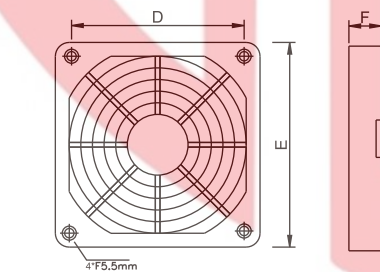

型号 Size Model	D	E	F
JL-92H(B)	82.5	92	3.5

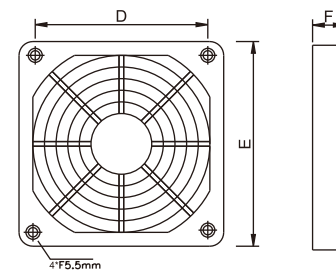
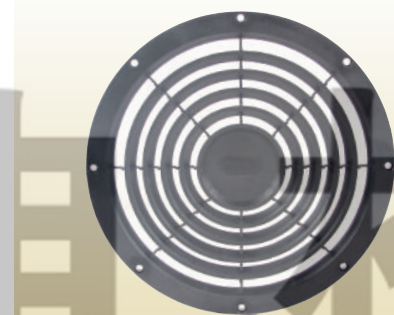
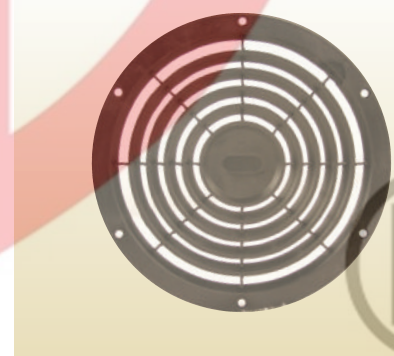
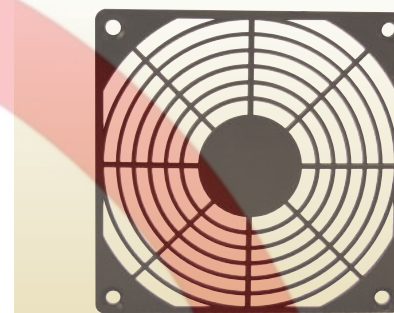

型号 Size Model	D	E	F
JL-120H(B)	105	120	4.5

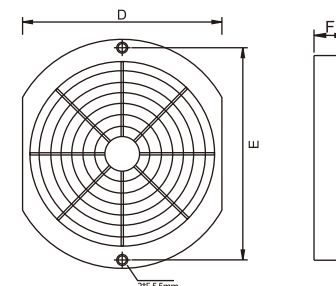

型号 Size Model	D	E	F
JL-172H(B)	150	162	4.5

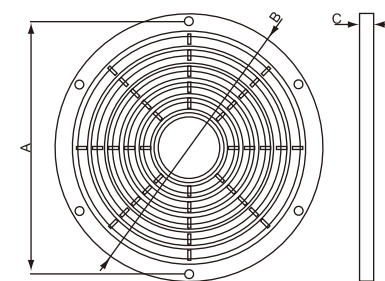

型号 Size Model	A	B	C
JL-220H(B)	212	227	12

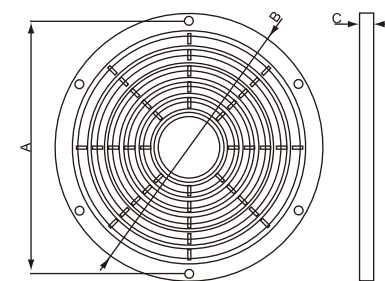

型号 Size Model	A	B	C
JL-254H(B)	246	259	12

九 龙 电 机

金属屏蔽网

通风网本体材质：优质铝合金

滤网材质：304不锈钢丝网，精密冲压模具一次成型完成，美观、大方、具有耐热耐腐屏蔽功能。

除尘率：89%

适用于：60、80、92、120、150等风机配套

Material of filter screen: 304 stainless wire mesh, formed in one piece by using an accurate stamping mould, with fabulous shape and functions including heat resistance and corrosion resistance.

Dust removal rate: 89%

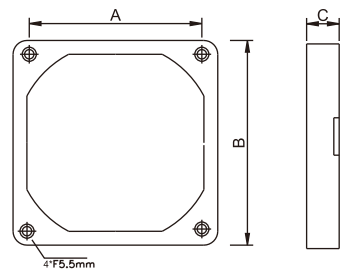
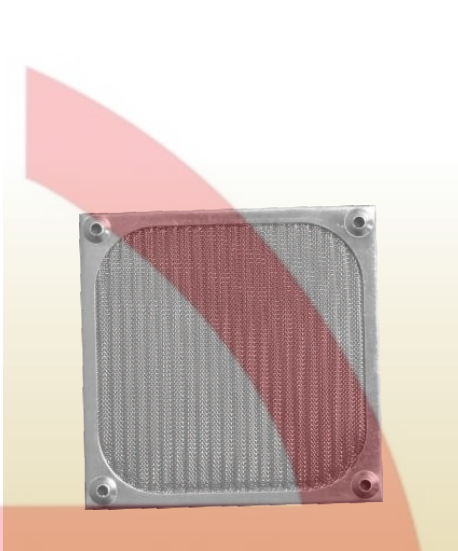
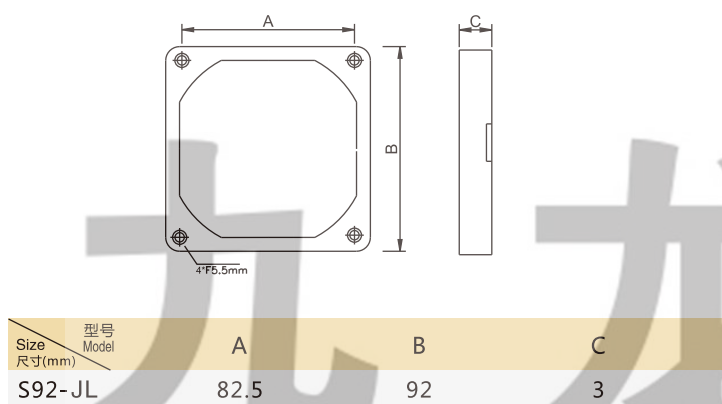
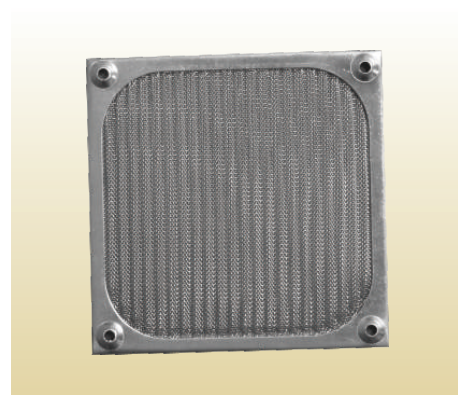
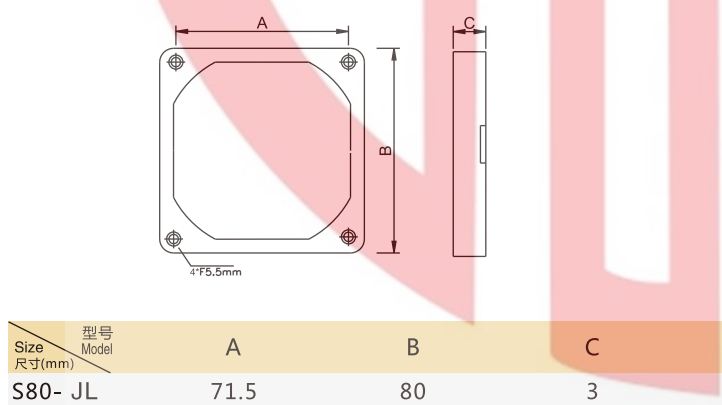
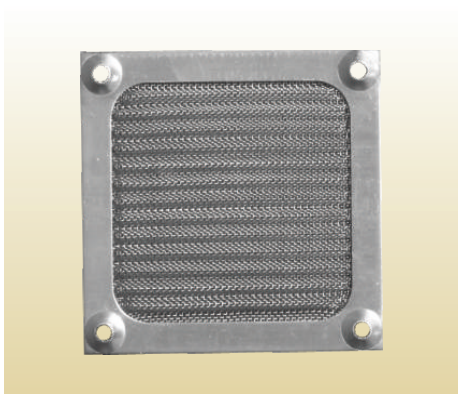
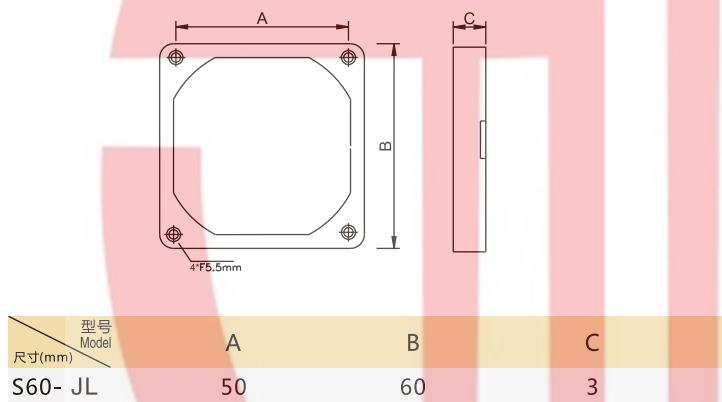
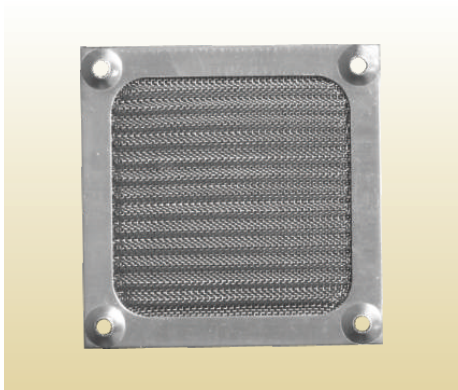

型号 Model	A	B	C
S120- JL	105	120	3

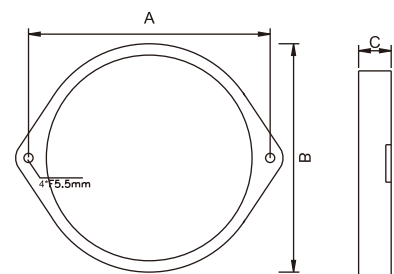
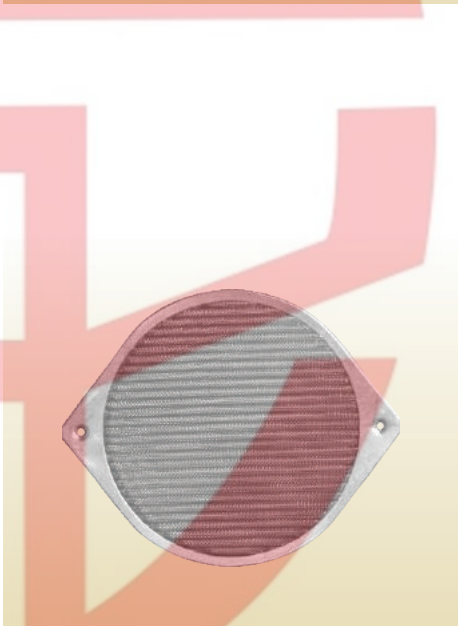

型号 Model	A	B	C
S150- JL	162	150	3

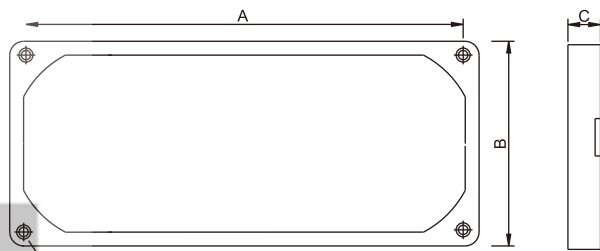
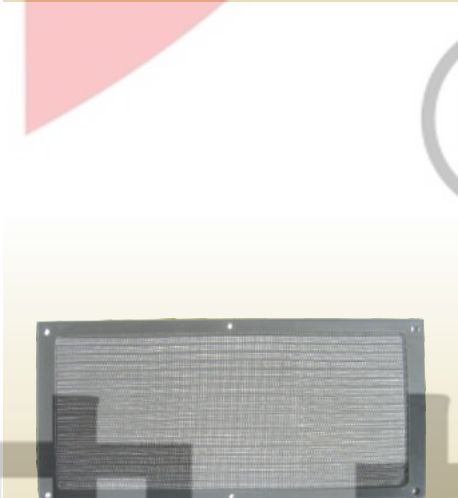

型号 Model	A	B	C
S220- JL	218	94	3



JIULONG MOTOR
AC/DC FANS COOLING FANS



本样图仅供参考，具体以实物为准。
This sample book is for reference only. Please refer to the specification for details.
如特殊电压也可根据需求提供。本公司保留技术更改权利。
Special voltage may be provided according to the requirement. All technical modification rights reserved.

Http://www.xtgygs.cn

金属防护网罩简介

About Metal Protection Mesh Cover

防护网材质: C1008光泽金属线、304不锈钢

表面处理: 光泽镍铬电镀

焊接处能承受88磅拉力试验

防护等级IP40

适用于40、50、60、70、80、92、110、120、127、135、150、172、180、200、220、254等风机配套使用。

Material: C1008 lustrous metal wire and 304 stainless steel

Surface treatment: lustrous Nickel Chrome plating

With welding point bearing force of 88 pounds

IP code: IP40

Applicable to fans of 40, 50, 60, 70, 80, 92, 110, 120, 127, 135, 150, 172, 180, 200, 220 and 254.

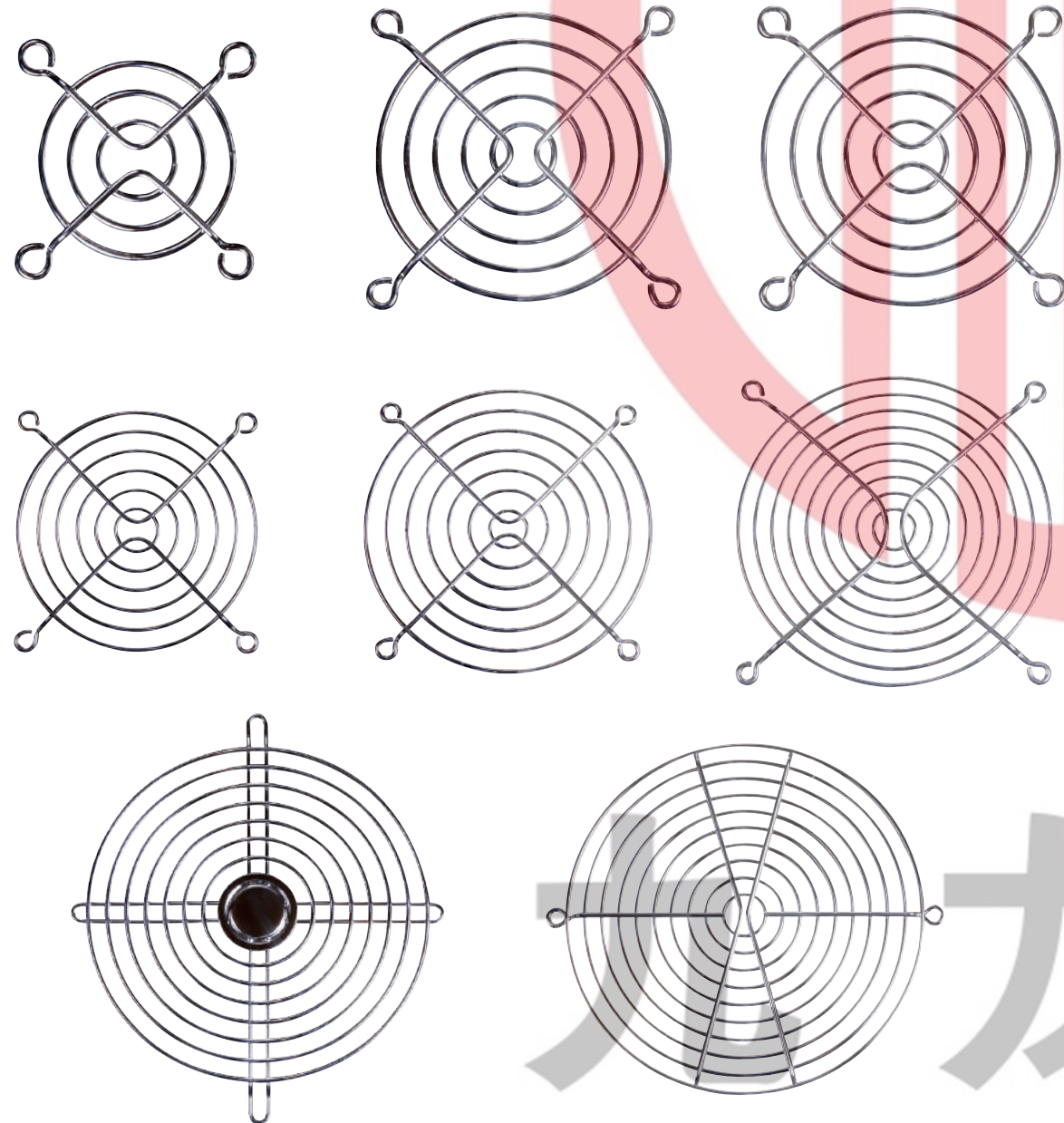

Metal Finger Guard

JL-03 For 30mm Fan

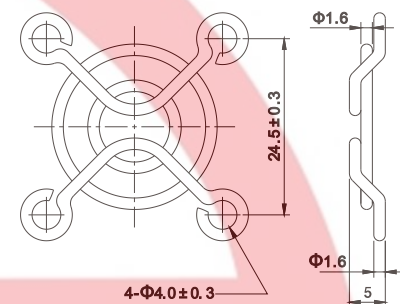

JL-04 For 40mm Fan

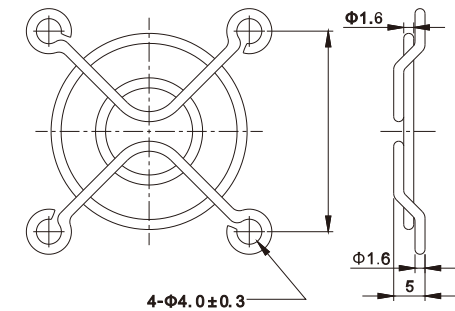

JL-05 For 50mm Fan

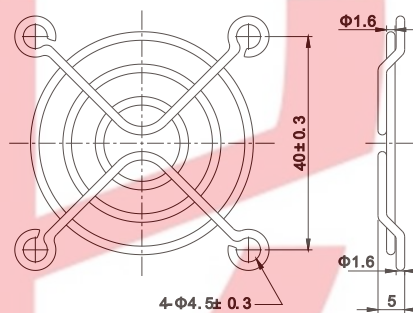

JL-06 For 60mm Fan

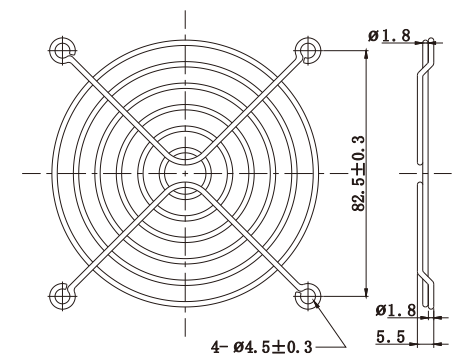

JL-08 For 80mm Fan

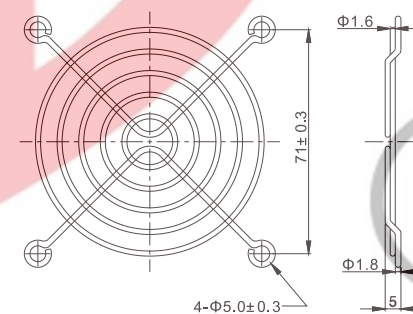

JL-09 For 92mm Fan

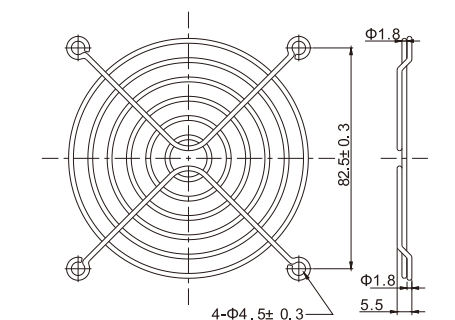

JL-12 For 120mm Fan

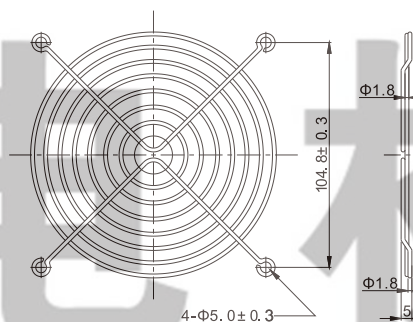

JL-15 For 150mm Fan

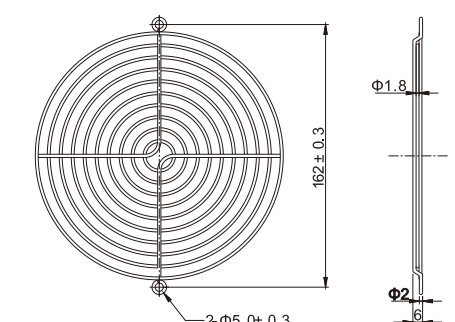

AC Axial Fan
AC轴流风机

AC All-Metal Axial Fan
AC全金属轴流风扇

DC Axial Fan
DC轴流风机

DC Centrifugal Fan
DC离心风机

EC Axial Fan
EC轴流风机

EC Centrifugal Fan
EC离心风机

AC Centrifugal Fan
AC离心风机

Fan Accessories
风机配件



本样图仅供参考，具体以规格书为准。
This sample book is for reference only. Please refer to the specification for details.
如需特殊电压也可根据规格书提供。本公司保留技术更改权利。
Special voltage may be provided according to the enquiry, although technical modification is reserved.

JL-40 FOR 40MM FAN

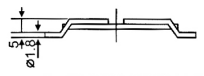
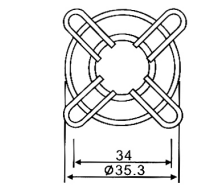

JL-92 FOR 92MM FAN

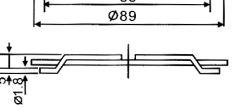
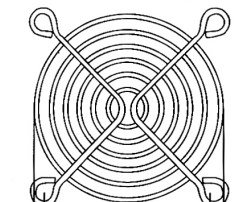

JL-170 FOR 170MM FAN

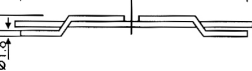
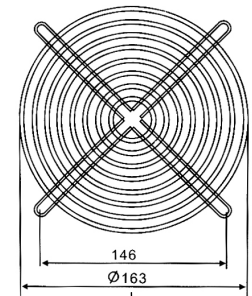

JL-200 FOR 200MM FAN

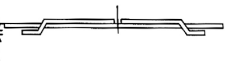
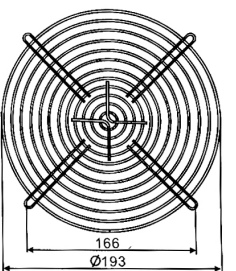

JL-50 FOR 50MM FAN

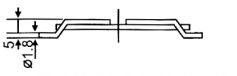
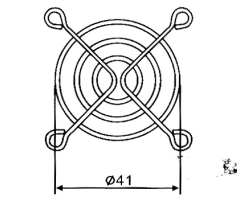

JL-110 FOR 110MM FAN

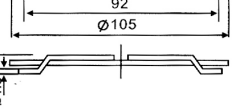
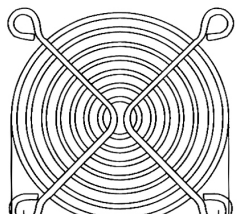

JL-150 FOR 150MM FAN

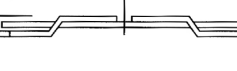
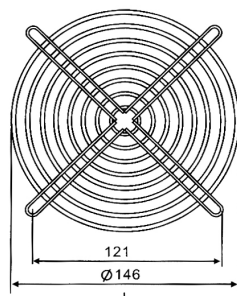

JL-220 FOR 220MM FAN

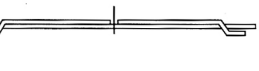
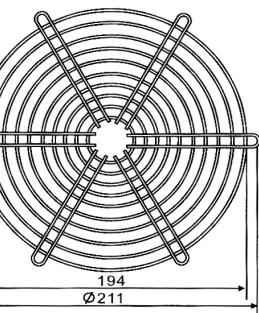

JL-60 FOR 60MM FAN

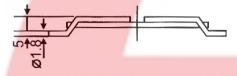
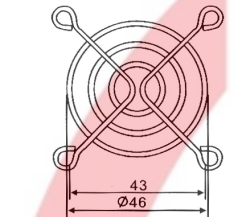

JL-120 FOR 120MM FAN

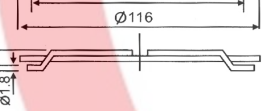
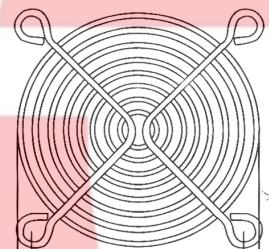

JL-160 FOR 160MM FAN

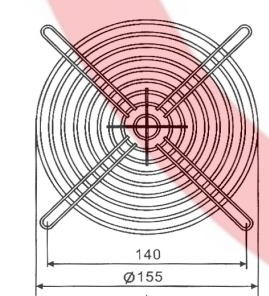

JL-250 FOR 250MM FAN

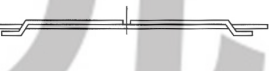
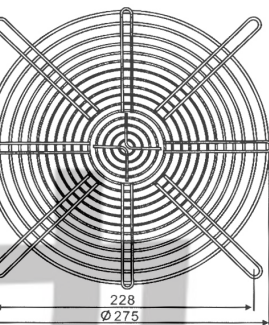

JL-80 FOR 80MM FAN

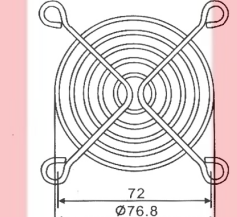

JL-135 FOR 135MM FAN

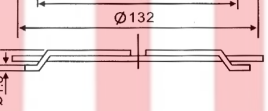
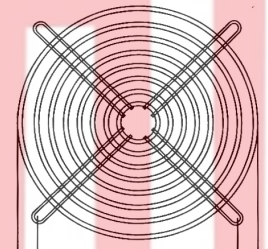

JL-180 FOR 180MM FAN

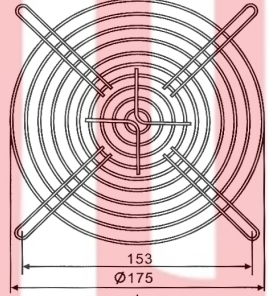

JL-300 FOR 300MM FAN

