

TAIS *Cube*

DISTRIBUTION BOARDS IN THERMOSETTING (GRP)



WITH THE REVOLUTIONARY CLIPPING SYSTEM





Suitable for thermal power plants, cement plants, mineral oil extraction plants, nuclear plants and laboratories, commercial and exhibition activities, airports, railway and underground facilities.



Resistant to everything thanks to the Palazzoli thermosetting material

GOOD DESIGN
INTERNATIONAL AWARD



TAIS Cube has a very high protection rating, IP66. This characteristic, certified with a laboratory test, guarantees the product against strong water jets.

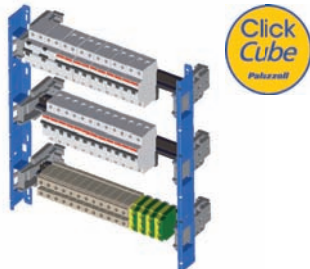

The steel frame allows to easily mount modular devices and cable trunkings and to comfortably wire everything on the bench, out of the board. The wired frame can then be easily inserted inside through a **click**. The material it is made of guarantees robustness and durability over time.

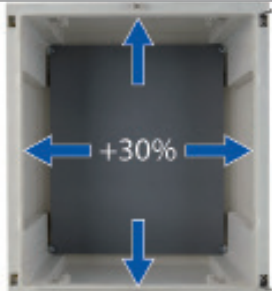

The board special design makes this series of products very wide and spacious. Consequently the back plate and door, either blind or transparent, offer 15% of extra space available if compared with similar sizes of the major competitors.



The door hinges, made of stainless steel and nicked brass, are located far from the edges to avoid eventual breakings in case of falls or impacts.



Size	N. vertical modules	N. EN 50022 modules	External dimensions	Internal usable dimensions	Distribution board with blind door	Distribution board with transparent door
1	-	-	260x305x160	200x250x100	550001	550031
2	3	36 (3X12)	340x430x180	280x375x120	550002	550032
3	3	54 (3X18)	450x505x220	390x450x160	550003	550033
4	4	72 (4X18)	450x655x220	390x600x160	550004	550034
5	4	96 (4X24)	560x655x260	500x600x200	550005	550035
6	5	140 (5X28)	630x810x300	570x750x235	550006	550036
7	5	200 (5X40)	850x1060x350	790x1000x290	550007	550037

THE REVOLUTIONARY  CLIPPING SYSTEM













 insert the holders

 assemble the frame

 insert the frame



AUTOMATION			DISTRIBUTION 					
								
Back plate in steel	Back plate in thermosetting (GRP)	Inner door in thermosetting (GRP)	Click Cube functional frame	Click Cube windowed panel	Click Cube blind panel	Click Cube blind double panel	Click Cube EN 50022 rail	Click Cube partial back plate in steel
550601	550621	-	-	-	-	-	-	-
550602	550622	550502	550562	550522	550542	550552	550582	550632
550603	550623	550503	550563	550523	550543	550553	550583	550633
550604	550624	550504	550564					
550605	550625	550505		550525	550545	550555	550585	550635
550606	550626	550506	550566	550526	550546	550556	550586	550636
550607	-	550507	550567	550527	550547	550557	550587	550637

COMMON ACCESSORIES				
				
Set of 4 brackets			Support for pole mounting	
Zinc steel	Stainless steel	Security lock	For sizes 1-2	For sizes 3-4-5
550640	550641	550680	550642	550643



TAIS Cube series distribution and automation boards are a range of products in thermosetting (GRP) for heavy duty uses with IP66 protection rating and resistant to UV rays. The system is composed of 7 sizes in the versions with blind or transparent door. The accessories to use the board in typical configurations of automation are the back plate in steel sheet or in thermosetting (GRP) and the inner door in thermosetting (GRP), equipped with opening handles and that can be installed at two different positions and fixed on both sides.

In the configuration for distribution, the steel frame allows modular compositions with blind or windowed moulded panels, EN 50022 rails that can be regulated at different depths, and partial back plates. All the elements can be fixed with the "Click Cube" clipping system.

Wiring can be done on the bench, out of the board or directly inside the board. The door is fixed to the back box with elements in nicked brass and stainless steel located far from the edges and that allows an opening wider than 180°.

Conformity to standards	IEC/EN 62208
Material	Thermosetting (GRP)
Protection rating (IP as per IEC/EN 60529)	IP66
Colour	RAL7035
Resistance to abnormal heat and fire ("Glow Wire" as per IEC/EN 60695-2-10)	960°C
Self-extinguishing grade (as per UL94)	V0
Resistance to impacts (IK rating as per IEC/EN 62262)	IK10
Rated frequency	0 - 1000 Hz
Rated voltage AC	AC 1000 Vac
Rated voltage DC	DC 1500 Vdc
Rated impulse seal voltage	8kV
Maximum short-circuit current	Idc 35kA
Insulation class	II
Operating temperature	-30°C - +100°C



Resistance to chemical agents

WATER	SALINE ATMOSPHERES	ACIDS		CHEMICAL BASES		SOLVENTS			
		CONCENTRATED	DILUTED	CONCENTRATED	DILUTED	ALCOHOL	ACETONE	PERCHLOROETHYLENE	BENZENE
↑	↑	→	↑	↑	↑	↑	↑	↑	↑
OILS		FATS		AMMONIA	OXIDIZERS	INORGANIC SALTS	GASOLINE	DETERGENTS	U.V. RAYS
MINERAL	VEGETABLE	ANIMAL	SYNTETHIC						
↑	↑	↑	↑	↑	↑	↑	↑	↑	↑

Legend: ↑ high resistance → partial resistance



Distribution boards in thermosetting (GRP) with blind door IP66

Size	External dimensions (mm)	Internal usable dimensions (mm)	Power dissipation allowed when empty (W)	Palazzoli code	Pack Q.ty
1	260x305x160	200x250x100	53	550001	1
2	340x430x180	280x375x120	90	550002	1
3	450x505x220	390x450x160	138	550003	1
4	450x655x220	390x600x160	174	550004	1
5	560x655x260	500x600x200	217	550005	1
6	630x810x300	570x750x235	302	550006	1
7	850x1060x350	790x1000x290	506	550007	1

Equipment included: key with triangular insert, screwcaps for double insulation.
Note: the completed installation in conditions of extremely variable climate may require the use of anti-condensation devices.



Distribution boards in thermosetting (GRP) with transparent door IP66

Size	External dimensions (mm)	N. EN 50022 modules	Power dissipation allowed when empty (W)	Palazzoli code	Pack Q.ty
1	260x305x160	-	53	550031	1
2	340x430x180	36 (3x12)	90	550032	1
3	450x505x220	54 (3x18)	138	550033	1
4	450x655x220	72 (4x18)	174	550034	1
5	560x655x260	96 (4x24)	217	550035	1
6	630x810x300	140 (5x28)	302	550036	1
7	850x1060x350	200 (5x40)	506	550037	1

Equipment included: key with triangular insert, screwcaps for double insulation.
Note: the completed installation in conditions of extremely variable climate may require the use of anti-condensation devices.

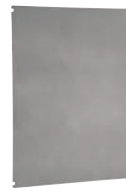

Back plates in steel

Size	Dimensions (mm)	Palazzoli code	Pack Q.ty
1	180x240	550601	5
2	260x370	550602	5
3	370x445	550603	5
4	370x595	550604	1
5	475x595	550605	1
6	550x745	550606	1
7	765x995	550607	1

Equipment included: complete with screws for mounting.



Back plates in thermosetting (GRP)

Size	Dimensions (mm)	Palazzoli code	Pack Q.ty
1	180x240	550621	5
2	260x370	550622	5
3	370x445	550623	5
4	370x595	550624	1
5	475x595	550625	1
6	550x745	550626	1

Equipment included: complete with screws for mounting.



Inner doors in thermosetting (GRP)

Size	Dimensions (mm)	Palazzoli code	Pack Q.ty
2	280x375	550502	4
3	388x450	550503	4
4	388x600	550504	4
5	496x600	550505	1
6	568x750	550506	1
7	784x1000	550507	1

Characteristics: the inner door is reversible and easy to open through the handles. It can be used as back plate.



Click Cube functional frames in steel, for the installation of front panels and EN 50022 rails



Size	N. installable panels	Palazzoli code	Pack Q.ty
2	3	550562	6
3	3	550563	6
4-5	4	550564	4
6	5	550566	2
7	5	550567	1

Equipment included: complete with holders for mounting.

Characteristics: it allows the wiring of the modular panels outside of the board and the installation of EN 50022 at different heights.



Click Cube front windowed panels with EN 50022 for modular devices



Size	Height (mm)	N. EN 50022 modules	Palazzoli code	Pack Q.ty
2	125	12	550522	6
3-4	150	18	550523	6
5	150	24	550525	4
6	150	28	550526	4
7	200	40	550527	1

Equipment included: modular covers.

Characteristics: quick fixing with ¼ turn screw insert.



Click Cube front blind panels at single height



Size	Height (mm)	Palazzoli code	Pack Q.ty
2	125	550542	6
3-4	150	550543	6
5	150	550545	4
6	150	550546	4
7	200	550547	1

Characteristics: quick fixing with ¼ turn screw insert.



Click Cube front blind panels at double height



Size	Height (mm)	Palazzoli code	Pack Q.ty
2	250	550552	4
3-4	300	550553	4
5	300	550555	1
6	300	550556	1
7	400	550557	1

Characteristics: quick fixing with ¼ turn screw insert.



Click Cube EN 50022 rails reinforced for frames



Size	N. EN 50022 modules	Palazzoli code	Pack Q.ty
2	12	550582	6
3-4	18	550583	6
5	24	550585	2
6	28	550586	2
7	40	550587	1

Equipment included: complete with screws for mounting.



Click Cube partial back plates in steel, adjustable in depth



Size	Height (mm)	Palazzoli code	Pack Q.ty
2	125	550632	1
3-4	150	550633	1
5	150	550635	1
6	150	550636	1
7	200	550637	1

Equipment included: complete with screws for mounting.



Set of **brackets**
for wall mounting

N. brackets	Material	Palazzoli code	Pack Q.ty
4	Zincd steel	550640	20
4	Stainless steel	550641	5

Characteristics: they can be mounted horizontally, vertically or hidden, retaining the double insulation.



Pair of **accessories**
for pole mounting

Size	Material	Palazzoli code	Pack Q.ty
1-2	Steel	550642	1
3-4-5	Steel	550643	1

Characteristics: predispositions for metal cable tie for mounting on poles with diameter larger than 80mm.



Security lock
with handle

N. keys	Material	Palazzoli code	Pack Q.ty
2	Steel	550680	10

Characteristics: closing with Yale code key.

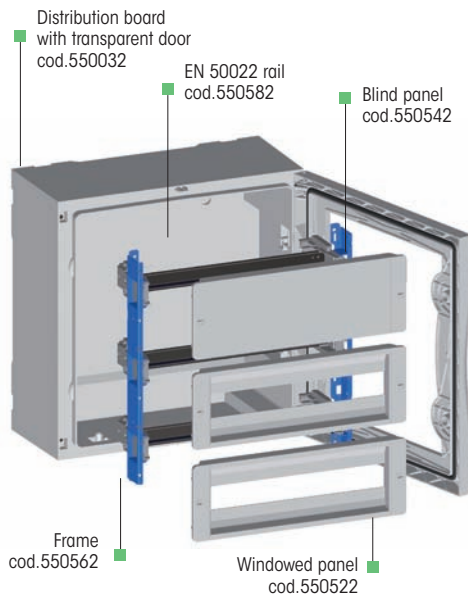

Click Cube
spacer kit



Size	Length (mm)	Palazzoli code	Pack Q.ty
2	70	550662	1
3-4	110	550663	1
5	150	550665	1
6	190	550666	1
7	240	550667	1

Note: the kit must be used to install Click Cube functional frames in the distribution boards without predisposition (before 2015).



Click Cube
brackets
for fixing cable trunkings



N. brackets	Material	Palazzoli code	Pack Q.ty
8	Steel	550648	1

Equipment included: complete with screws for mounting.

Note: for all the sizes of functional frames.

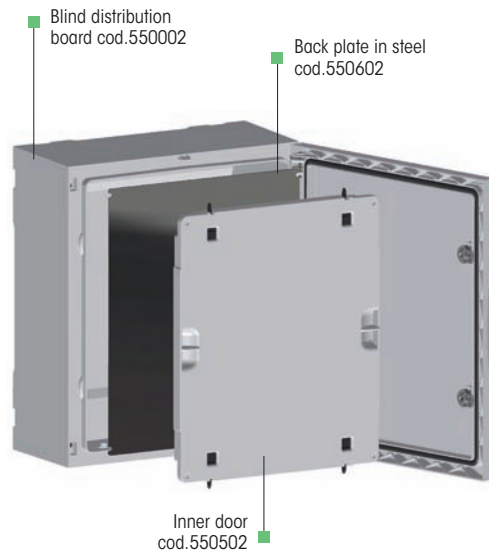



MORE ADVANTAGES



WITH TAIS CUBE

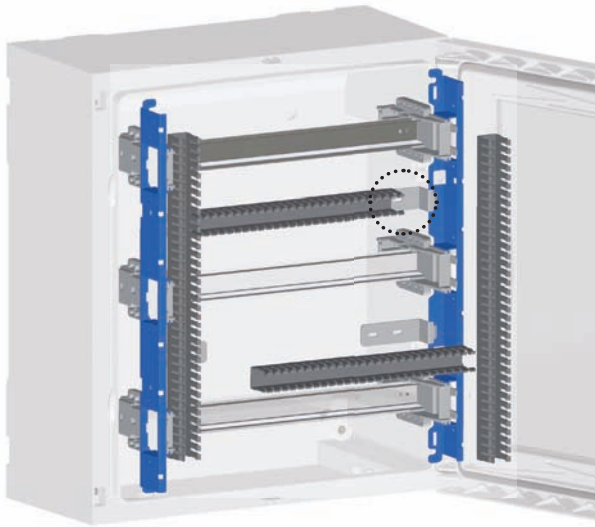
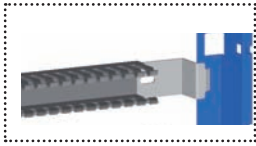

FRAME + BRACKETS + TRUNKINGS
Fixing of the cable trunkings horizontally and vertically using the brackets

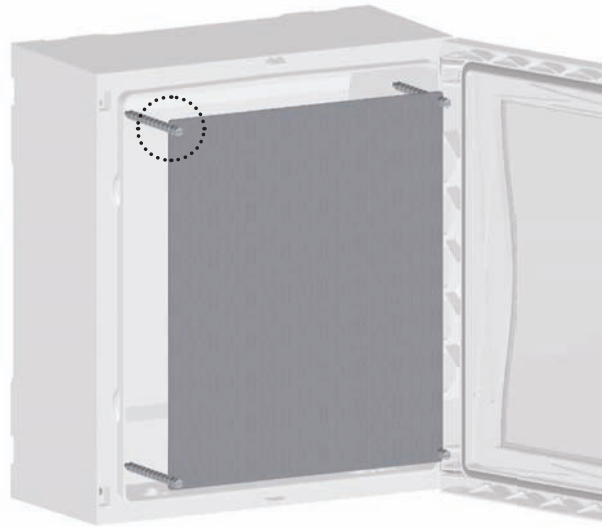

SPACERS + BACK PLATE
Back plate adjustable in depth using the spacer

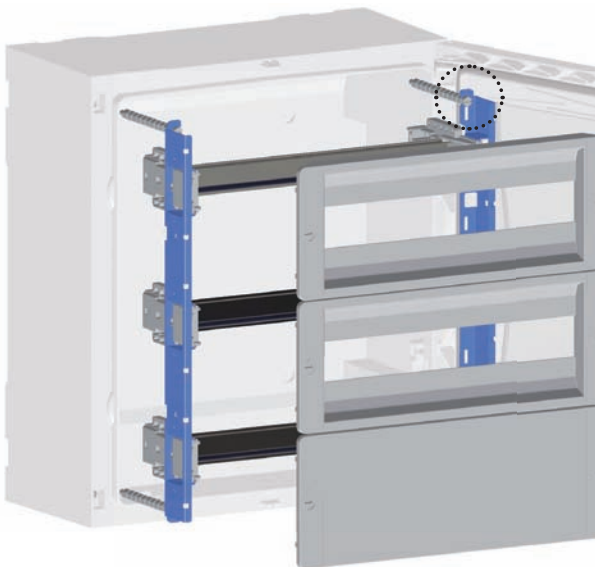

FRAME + PANELS + SPACERS
Frame adjustable in depth using the spacer

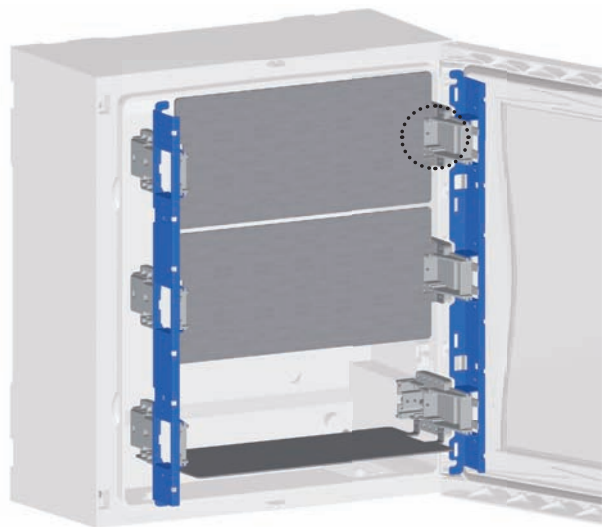
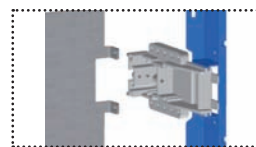

FRAME + PARTIAL BACK PLATES
Partial back plate adjustable in depth or in flat position

TAIS Cube

WITH THE REVOLUTIONARY CLIPPING SYSTEM



 insert the holders

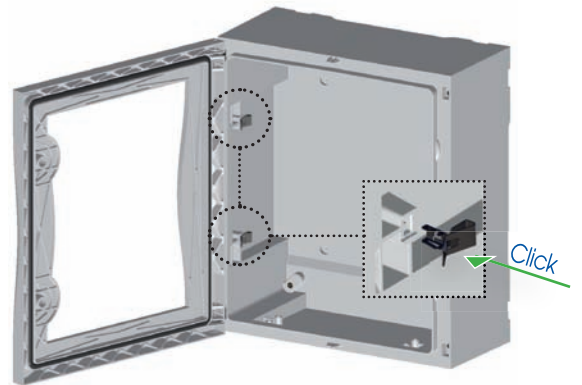

 assemble the frame



 insert the frame

