

NM1 Interruptores en Caja Moldeada

General	Página 59
Composición referencia	Página 59
Clasificación	Página 59
Condiciones de trabajo	Página 60
Características técnicas	Página 61
Relé magnetotérmico	Página 64
Despiece	Página 65
Curvas de disparo	Página 67
Coefficiente de corrección compensación de temperatura	Página 70
Terminales	Página 70
Dimensiones generales y de montaje	Página 73
Accesorios	Página 76
Información técnica adicional	Página 81
Tabla de pares de apriete	Página 82
Poder de corte a distintas tensiones	Página 82
Protección en cascada	Página 84

6. Relé magnetotérmico

Apertura en tiempo inverso en caso de disparo del interruptor por sobrecorriente (para distribuciones de potencia) en las situaciones en que todos los polos hayan sido alimentados simultáneamente.

Secuencia	Comprobación de la corriente	I _n	Tiempo convencional	Estado inicial
1	Corriente en disparo convencional	1,05 I _n (n<=63A)	2h(n<=63A)	Estado en frío
2	Corriente en disparo convencional	1,30 I _n (n<=63A)	2h(n<=63A)	Justo después de la sec. n°1

Apertura en retardo de tiempo inverso en caso de disparo del interruptor por sobrecorriente (para protecciones de motor) en las situaciones en que todos los polos hayan sido alimentados simultáneamente (según UNE-EN60947-3).

Secuencia	Ajuste de corriente convencional	Tiempo convencional	Estado inicial	Notas
1	1,0 In	>=2h	Estado frío	
2	1,2 In	<=2h	Auto después de puesta n°1	
3	1,5 In	<=4min	Estado frío	10<=I<=225
4	7,2 In	<=8min	Estado frío	225<=I<=630
		4<=I<=10s	Estado frío	10<=I<=225
		6<=I<=20s	Estado frío	225<=I<=630

El neutro del interruptor 4P se encuentra en el lado derecho del mismo. Consultar la corriente nominal del disparador del neutro, en caso de los tipos C y D en la siguiente tabla.

Corriente base del aparato (A)	Corriente nominal (A)	Corriente nominal del neutro (A)
10	10	10
16	16	16
20	20	20
25	25	25
30	30	30
32	32	32
40	40	40
50	50	50
60	60	60
63	63	63
16	16	16
20	20	20
25	25	25
30	30	30
32	32	32
40	40	40
50	50	50
60	60	60
63	63	63
75	75	63
80	80	63
100	100	63
125	125	63

7. Despiece

Interruptor en Caja Moldeada serie NIM1

- 1 Interruptor (tipo fip)
- 2 Interruptor (tipo enchufable)
- 3 Conexión posterior
- 4 Bobina de mínima tensión
- 5 Bobina de emisión de corriente
- 6 Contacto de alarma
- 7 Contacto auxiliar
- 8 Accionamiento motorizado
- 9 Mando manual con eje prolongado
- 10 Bloqueo mecánico
- 11 Terminal para cable (ver Pág.102)
- 12 Culebromes
- 13 Platina para conexión frontal

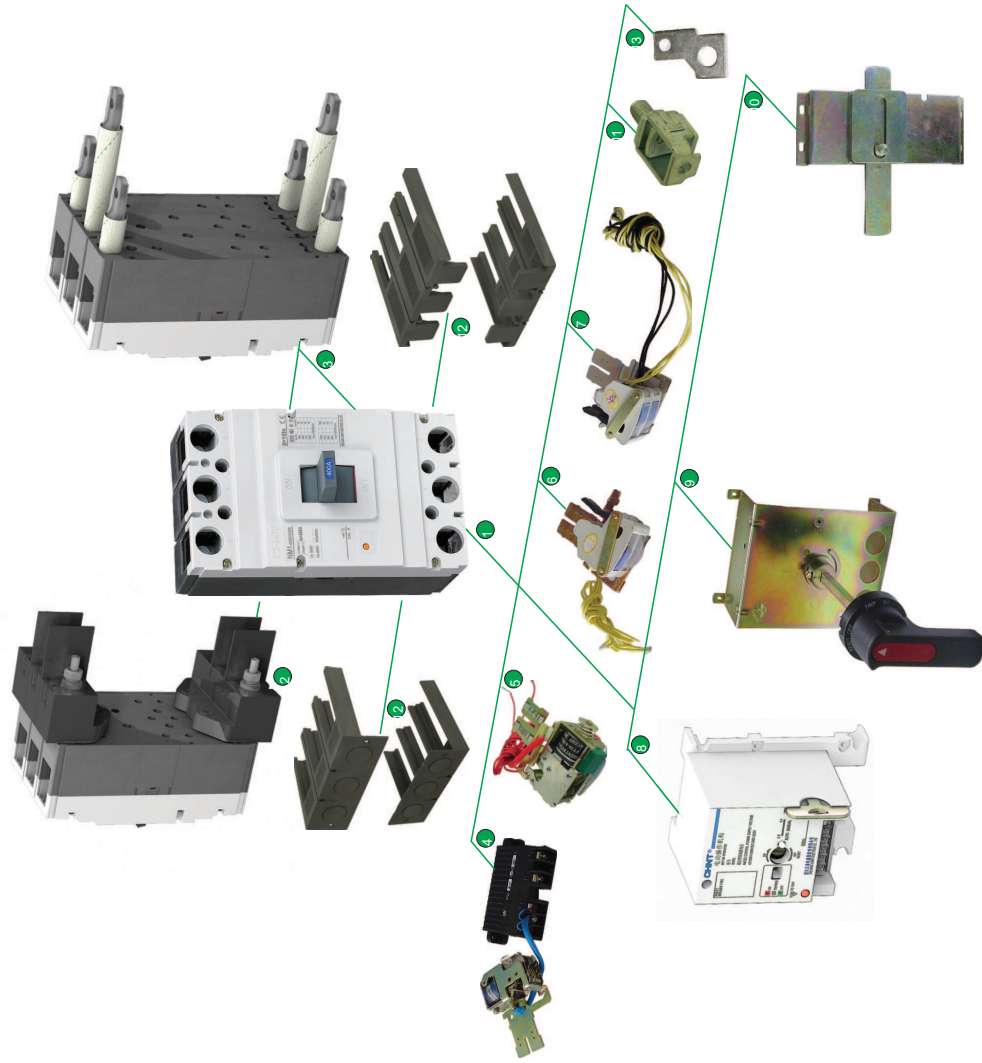

Nota: Bajo demanda pueden suministrarse aparatos con la corriente admisible en el neutro igual que la de las fases.

Calibre base del aparato	Corriente (A)	Código de poder de corte	Conexión frontal		
			Tornillo hexagonal (B)	Tornillo hexagonal (A)	Tornillo de cruz (C)
315		S		■	
		H		■	
		R		■	
400	350	S		■	
		H		■	
		R		■	
400	400	S		■	
		H		■	
		R		■	
400	400	S		■	
		H		■	
		R		■	
630	500	S		■	
		H		■	
		R		■	
630	630	S		■	
		H		■	
		R		■	
800	630	H	■		
		R	■		
		H	■		
800	700	H	■		
		R	■		
		H	■		
800	800	H	■		
		R	■		
		H	■		
1250	700	H	■		
		800	■		
		900	■		
		1000	■		
1250	1250	H	■		
		H	■		

Terminales de conexión

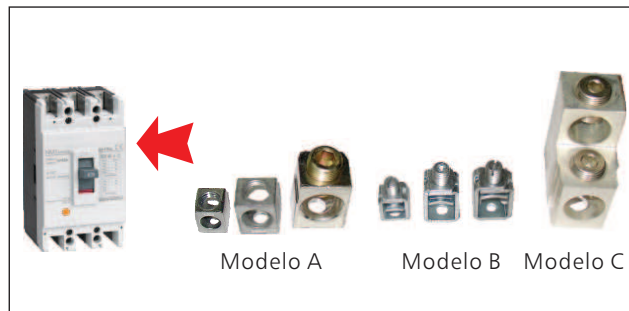

Conexión posterior

Conexión trasera disponible para interruptores de 3P y 4P
- NM1-63 a NM1-800



Conexión enchufable

Conexión enchufable disponible para interruptores de 3P y 4P
- NM1-63 a NM1-800

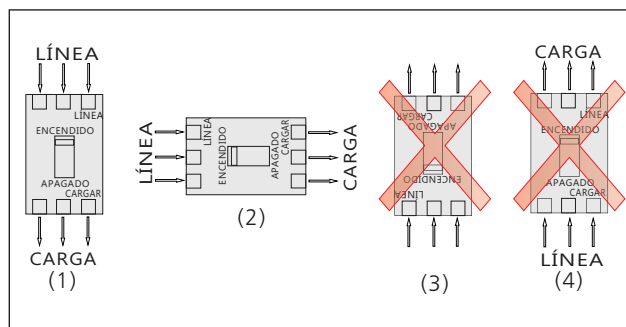

Los interruptores NM1 pueden ser conectados según se muestra en los dibujos (1) y (2). Puesto que el poder de corte del aparato puede verse afectado, el modo de conexión (3) no es recomendable sin el consentimiento y autorización de Chint. El modo de conexión (4) no está permitido para esta serie de interruptores.

(mm)

Dimensiones		NM1-63S NM1-63H	NM1-125S NM1-125H NM1-125R	NM1-250S NM1-250H NM1-250R	NM1-400S NM1-400H NM1-400R	NM1-630S NM1-630H NM1-630R	NM1-800H NM1-800R
Dimensiones de conexión trasera y modelo enchufable	A	25	30	35	44	58	70
	φ d	4.5	4.5×6	5.5	7	7	7
	φ d1	-	-	-	φ 12	φ 16	φ 16
	φ d2	6	8	8	9	9	12
	φ D	8	10	12	33	37	37
	φ D1	8	10	12	33	37	37
	H6	S:32 / H:23	63.5	67.5	39	45	64
	H7	S:47 / H:38	96.5	118.5	74	79	64
	H8	-	-	-	18	20	20
	H9	28	50	50	60	60	87
	H10	38	67.5	71.5	88	92	143.5
	H11	44.5	81	84.5	111	110	158.7
	H12	10	18	18	21.5	21	27
	L2	117	136	144	224	234	243
	L3	117	130.5	126	194	200	243
	L4	97	93	93	163	165	173
	L5	138	180	190	285	302	305
	L6	80/105*	95/125*	110/140*	150/198*	180/238*	215/285*
	M	M6	M8	M10	-	-	-
	K	50	60	70	60	100	90
K1	25	30	35	66	66	95	
J	60	58	54	130.4	124	146	
M1	M5	M8	M8	M10	M12	M12	
W1	25	30	35	48	58	70	
W2	12.5	15	17.5	24	29	35	

Nota: El "*" representa la dimensión de los interruptores de 3P/4P

11. Accesorios

Accesorios internos



Accesorios	Código de accesorio		Modo de montaje y conexiones				
	Disparador sólo magnético	Disparador compuesto	NM1-63S NM1-125C,S,H,R NM1-250C,S,H,R	NM1-63S,H NM1-125C,S,H,R NM1-250C,S,H,R NM1-400S,H,R	NM1-630S,H,R	NM1-800H, R	NM1-1250H
			2P	3P 4P	3P 4P	3P 4P	3P
Sin accesorios	200	300					
Contacto de alarma	208	308					
Bobina de cierre	210	310					
Contacto auxiliar	220	320					
Bobina de emisión	230	330					
Bobina de cierre, contacto auxiliar	240	340					
Bobina de cierre, bobina de emisión	250	350					
Dos grupos de contactos auxiliares	260	360					
Contacto auxiliar, bobina de emisión	270	370					
Bobina de cierre, contacto de alarma	218	318					
Contacto de alarma auxiliar	228	328					
Bobina de emisión, contacto de alarma	238	338					
Bobina de cierre, contacto auxiliar	248	348					
Dos grupos de contacto auxiliar del contacto de alarma auxiliar	268	368					
Bobina de emisión, contacto de alarma auxiliar	278	378					

11.1 Bobina de mínima

- a. $U_n=70\sim35\% U_s$, la bobina puede actuar
- b. $U_n=<35\% U_s$, impide la conexión del interruptor
- c. $U_n=>85\% U_s$, conexión segura

Tensión nominal de la bobina de mínima: 50Hz, 230Vca y 400Vca

Códigos de la bobina de mínima

Código	A2	A4	D1	D2
Tensión	230Vca	400Vca	110Vcc	220Vcc
Frecuencia nominal	50Hz	50Hz	-	-

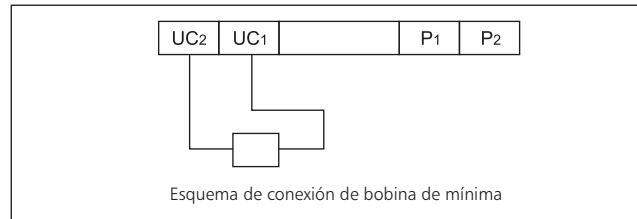

11.2 Bobina de emisión

La tensión de control nominal de la bobina de emisión es 50Hz, 230V y 400V.

$U_n=70\%\sim110\% U_s$, conexión segura

Código de bobina de emisión

Código	A1	A2	A4	D1	D2	D3
Tensión	110/127Vca	230Vca	400Vca	110Vcc	220Vcc	24Vcc
Frecuencia nominal	50Hz	50Hz/ 60Hz	50Hz/ 60Hz	-	-	-

Nota: Con una tensión de 24Vcc, la corriente nominal es de $5A\pm 10\%$

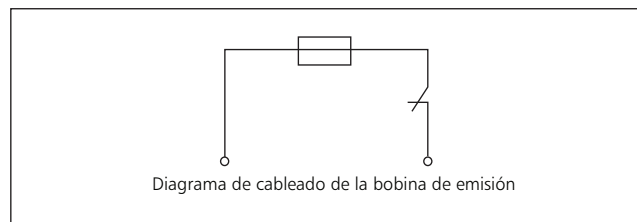
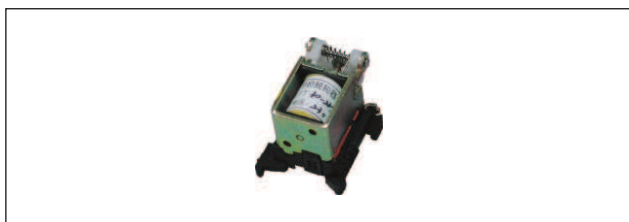

11.3 Contacto auxiliar

Calibre del interruptor	Corriente térmica convencional I_{th} (A)	Corriente nominal I_e (A) a 400 Vca	Corriente nominal I_e (A) a 230 Vcc
$I_{nm}\leq 225A$	3	0.26	0.14
$I_{nm}\geq 400A$	6	3	0.2

a. Contacto auxiliar



b. Contacto de alarma

Cuando el interruptor conecta y corta, el contacto de alarma no funciona. Tras la activación del contacto de alarma debido a un disparo libre (o disparo por fallo), y después de que el interruptor vuelva a funcionar, el contacto de alarma volverá a su estado original.

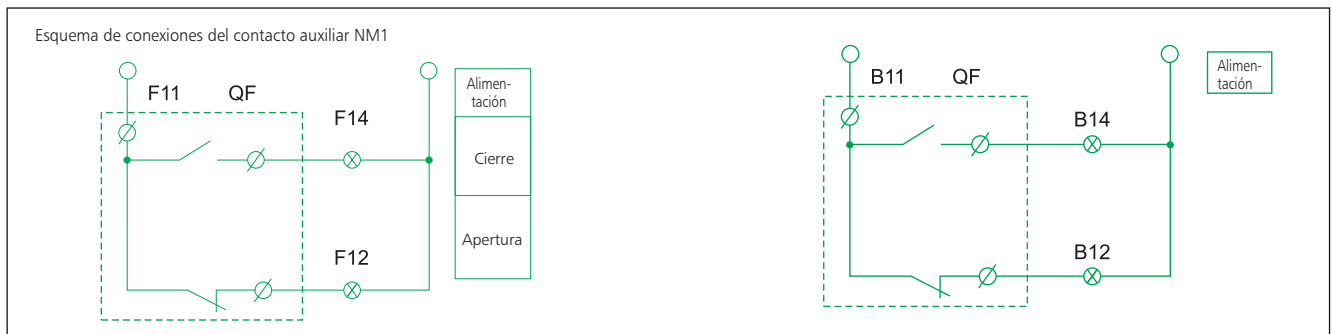
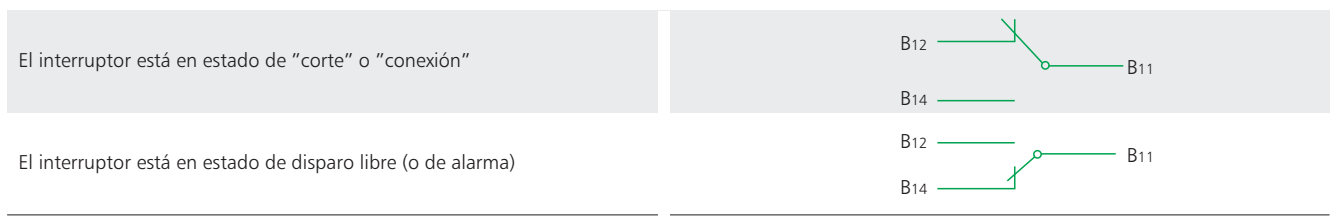

Accesorios externos

11.4 Accionamiento motorizado

Características	Modelo	NM1-63 NM1-125, NM1-250, NM1-400, NM1-630, NM1-800, NM1-1250
Estructura	Sistema electromagnético	Motor
Códigos de CA/CC	A1/D1, A2/D2, A4, D3	

Nota: A1=110Vca, A2=230Vca, A4=400Vca, D1=110Vcc, D2=220Vcc, D3=24Vcc

Esquema de cierre y apertura del mecanismo de accionamiento motorizado (CA) de NM1-400, 630, 800, 1250

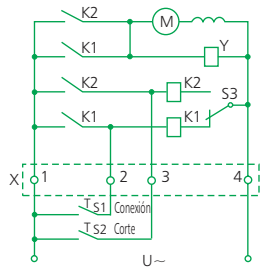

Con relé de cierre automático

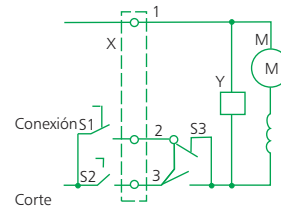

Sin relé de cierre automático

Características: 50Hz 230Vca y 400Vca

Mando manual rotativo

Gráfico de montaje del mando manual rotativo

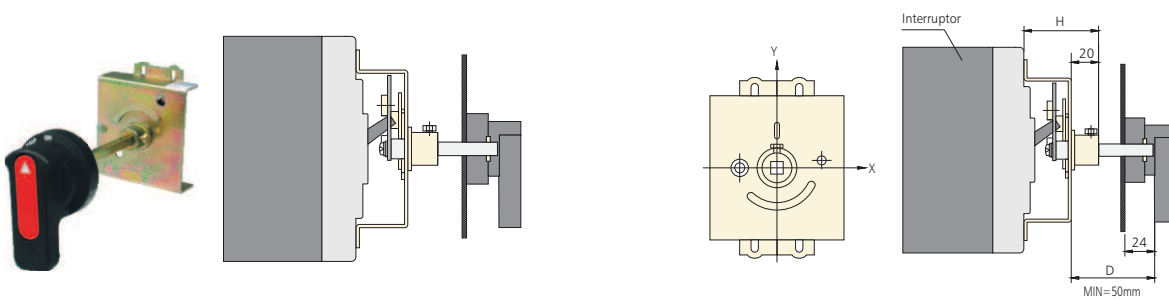

Dimensiones

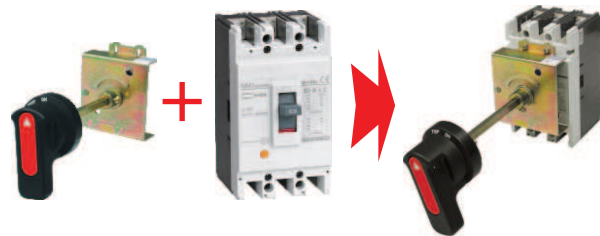
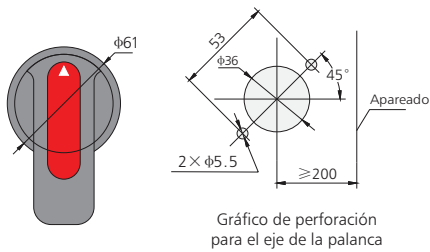

(mm)

Modelo	NM1-63	NM1-125	NM1-250	NM1-400	NM1-630	NM1-800H NM1-800R
Tamaño de montaje	49	51	54	88	89	76
El valor Y de la palanca hace referencia al centro del interruptor	0	0	0	0	0	0

Dimensiones de montaje y perforación

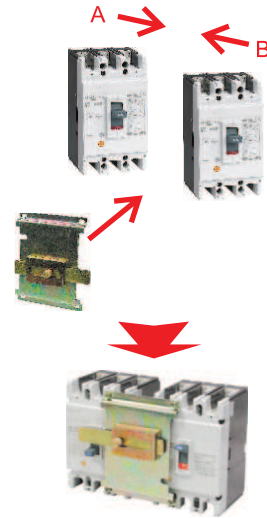
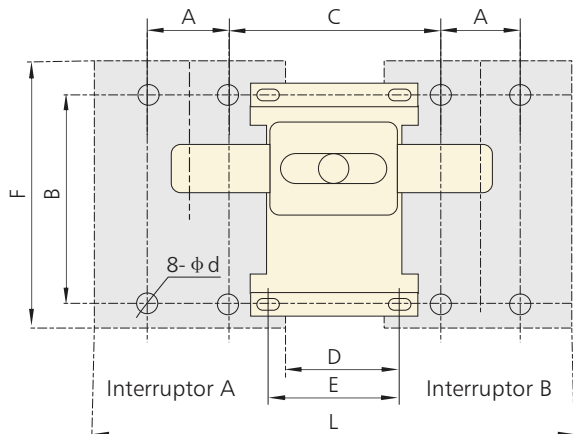

(mm)

Modelo	A	B	C	D	E	F	L	Φd
NM1-63	25	117	80	30	80	135	182	4.5
NM1-100	30	130.5	90	30	90	155	210	4.5×6*
NM1-225	35	126	100	30	100	165	240	5.5
NM1-400	44	194	136	30	40	257	330	7
NM1-630	58	200	172	48	62	270	412	7
NM1-800	70	243	167	28	40	280	448	7

Nota:

- * representa la dimensión de perforación.
- Instalar el interruptor sobre el marco y a continuación el bloqueo mecánico sobre el interruptor.

12. Información técnica adicional

- 12.1 Bajo consulta a Chint, dependiendo de las características de servicio de los NM1-225, es posible aumentar su corriente nominal hasta 250A.
- 12.2 Los interruptores NM1-1250 se suministran de serie con pletinas de conexión. Si se requieren pletinas de conexión para otros calibres de interruptores NM1 éstas deberán solicitarse aparte.
- 12.3 Sólo los interruptores de la serie NM1-H son aptos para ser usados como seccionador.
- 12.4 Existen cubrebornes para todos los modelos de la serie NM1. Con ellos los aparatos pueden alcanzar un grado de protección IP40 si están correctamente montados.

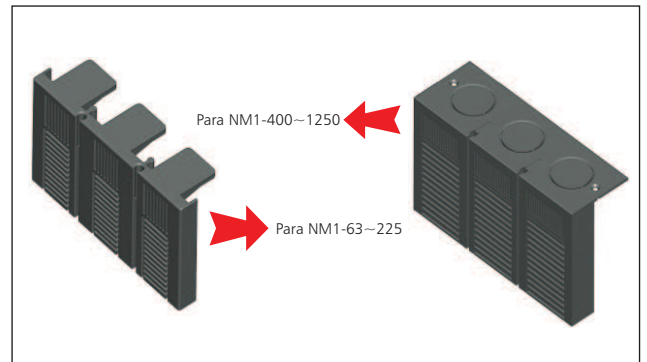

12.5 Distancia de seguridad entre dispositivos eléctricos a tener en cuenta en el montaje

(mm)

Distancias mínimas / Modelo	NM1-63	NM1-100	NM1-225	NM1-400	NM1-630	NM1-800	NM1-1250
Lado de línea	50	50	50	100	100	100	100
Lado de carga	20	20	20	20	20	20	20
Lado derecho	25	25	25	25	25	25	25
Lado izquierdo	25	25	25	25	25	25	25

12.6 Tabla de pares de apriete

Calibre del cable (cobre)		Corriente nominal (A)	Par de apriete (N · m)	
AWG/MCM	mm ²		Pletina frontal	Terminal
16-6	1.5-16	10 ≤ In ≤ 63	5	3
4-3	25-35	63 < In ≤ 100	10	8
2-4/0	50-95	100 < In ≤ 225	14	10
300-500	120-240	225 < In ≤ 400	18	16
250×2	150×2	400 < In ≤ 500	22	18
350×2	185×2	500 < In ≤ 630	26	20
500×2	240×2	630 < In ≤ 800	28	-
350×4	185×4	800 < In ≤ 1250	30	-

12.7 Datos técnicos de la serie NM1

Corriente base (A)	Modelo	Número de polos	Ui (V)	Icu/Ics (kA)				
				220V 240V	380V 415V	440V	480V 500V	660V 690V
63	NM1-63S	2	500	20/10	15/7.5	-	-	-
		3	500	20/10	15/7.5	10/5	-	-
	NM1-63H	3/4	500	42/21	35/17.5	20/10	-	-
125	NM1-125C	2	800	25/12.5	20/10	-	-	-
		3/4	800	25/12.5	20/10	15/7.5	10/5	3/1.5
	NM1-125S	2	800	42/21	25/12.5	-	-	-
		3/4	800	42/21	25/12.5	20/10	10/5	3/1.5
	NM1-125H	2	800	65/32.5	50/25	-	-	-
		3/4	800	65/32.5	50/25	42/21	25/12.5	8/4
NM1-125R	2	800	85/42.5	65/32.5	-	-	-	
	3/4	800	85/42.5	65/32.5	55/27.5	35/17.5	10/5	
250	NM1-250C	2	800	25/12.5	20/10	-	-	-
		3/4	800	25/12.5	20/10	15/7.5	10/5	5/2.5
	NM1-250S	1	800	20/10	-	-	-	-
		2	800	42/21	25/12.5	-	-	-
	3/4	800	42/21	25/12.5	20/10	10/5	5/2.5	
		NM1-250H	2	800	65/32.5	50/25	-	-
3/4	800		65/32.5	50/25	42/21	25/12.5	8/4	
NM1-250R	2	800	85/42.5	65/32.5	-	-	-	
	3/4	800	85/42.5	65/32.5	55/27.5	35/17.5	10/5	
400	NM1-400S	3/4	800	50/25	35/17.5	30/15	15/7.5	10/5
		3/4	800	85/42.5	50/25	42/21	25/12.5	12/6
	NM1-400R	3/4	800	100/50	70/35	65/32.5	42/21	15/7.5
630	NM1-630S	3/4	800	50/25	35/17.5	30/15	15/7.5	12/6
		3/4	800	85/42.5	50/25	42/21	25/12.5	15/7.5
	NM1-630R	3/4	800	100/50	70/35	65/32.5	40/20	20/10
800	NM1-800H	3/4	800	85/42.5	60/30	55/27.5	30/15	20/10
		3/4	800	100/50	70/35	65/32.5	40/20	20/10
1250	NM1-1250H	3	800	85/42.5	65/32.5	55/27.5	30/15	20/10

Corriente base (A)	Modelo	Número de polos	Ui (V)	Icu/Icm(kA)				
				220V 240V	380V 415V	440V	480V 500V	660V 690V
63	NM1-63S	2	500	20/40	15/30	-	-	-
		3	500	20/40	15/30	10/17	-	-
	NM1-63H	3/4	500	42/88.2	35/73.5	20/40	-	-
125	NM1-125C	2	800	25/52.5	20/40	-	-	-
		3/4	800	25/52.5	20/40	15/30	-	-
	NM1-125S	2	800	42/88.2	25/52.5	-	-	-
		3/4	800	42/88.2	25/52.5	20/40	-	-
	NM1-125H	2	800	65/43	50/105	-	-	-
		3/4	800	65/43	50/105	42/88.2	-	-
NM1-125R	2	800	85/187	65/143	-	-	-	
	3/4	800	85/187	65/143	55/121	-	-	
250	NM1-250C	2	800	25/52.5	20/40	-	-	-
		3/4	800	25/52.5	20/40	15/30	-	-
	NM1-250S	1	800	20/40	-	-	-	-
		2	800	42/88.2	25/52.5	-	-	-
	3/4	800	42/88.2	25/52.5	20/40	-	-	
		NM1-250H	2	800	65/43	50/105	-	-
	3/4		800	65/43	50/105	42/88.2	-	-
	NM1-250R	2	800	85/187	65/143	-	-	-
3/4		800	85/187	65/143	55/121	-	-	
400	NM1-400S	3/4	800	50/105	35/73.5	30/63	-	-
		3/4	800	85/187	50/105	42/88.2	-	-
	NM1-400R	3/4	800	100/220	70/154	65/143	-	-
630	NM1-630S	3/4	800	50/105	35/73.5	30/63	-	-
		3/4	800	85/187	50/105	42/88.2	-	-
	NM1-630R	3/4	800	100/220	70/154	65/43	-	-
800	NM1-800H	3/4	800	85/187	60/132	55/121	-	-
		3/4	800	100/220	70/154	65/143	-	-
1250	NM1-1250H	3	800	85/187	65/143	55/121	-	-

Nota: Los parámetros en negro son sólo orientativos

12.8 Protección en cascada
12.8.1 Tensiones: 220/230/240V

Aguas arriba: NM1-63~1250

Aguas abajo: eB, UB, DZ158, DZ267, NB1, NBH8, NM1-63~1250

Aguas arriba Poder de corte (kA RMS)	NM1-63S 20	NM1-63H 42	NM1-125S 25	NM1-125H 50	NM1-125R 65	NM1-250S 25	NM1-250H 50	
Aguas abajo ↓	Poder de corte (kA RMS)							
DZ267	20	40	20	35	50	20	25	
eB, UB	20	40	20	35	50	20	25	
NBH8	20	40	20	35	50	20	25	
NB1(Icn=6000A)	20	42	25	35	50	25	35	
NB1(Icn=10000A)	20	42	25	40	50	25	35	
DZ158			25	40	50	25	40	
NM1-63S		42	25	50	65	25	50	
NM1-63H					65			
NM1-125S				50	65		50	
NM1-125H					65			
NM1-250S							50	
NM1-250H								
NM1-400S								
NM1-400H								
NM1-630S								
NM1-630H								
NM1-800H								
NM1-1250H								DZ47, eB, UB, DZ158, DZ267, NB1, NBH8, NM1-63~1250

12.8.2 Tensiones: 380/400/415V

Aguas arriba: NM1-63~1250

Aguas abajo: eB, UB, DZ158, DZ267, NB1, NBH8, NM1-63~1250

Aguas arriba Poder de corte (kA RMS)	NM1-63S 15	NM1-63H 35	NM1-125S 25	NM1-125H 50	NM1-125R 65	NM1-250S 25	NM1-250H 50	
Aguas abajo ↓	Poder de corte (kA RMS)							
eB, UB	10	15	10	15	15	10	15	
NB1(Icn=6000A)	15	20	15	20	20	15	20	
NB1(Icn=10000A)	15	20	20	25	25	20	25	
DZ158			20	25	35	20	25	
NM1-63S		35	25	50	65	25	50	
NM1-63H					65			
NM1-125S				50	65		50	
NM1-125H					65			
NM1-250S							50	
NM1-250H								
NM1-400S								
NM1-400H								
NM1-630S								
NM1-630H								
NM1-800H								
NM1-1250H								

NM1-250R 65	NM1-400S 35	NM1-400H 50	NM1-400R 70	NM1-630S 35	NM1-630H 50	NM1-630R 70	NM1-800H 60	NM1-800R 70	NM1-1250H 65
30									
30									
30									
35									
40									
50	30	40	50						
65									
65									
65		50	70		50	70	60	70	65
65			70			70		70	
65		50	70		50	70	60	70	65
65			70			70		70	
		50	70		50	70	60	70	65
			70			70		70	
					50	70			
						70			
								70	

NM1-250R 65	NM1-400S 35	NM1-400H 50	NM1-400R 70	NM1-630S 35	NM1-630H 50	NM1-630R 70	NM1-800H 60	NM1-800R 70	NM1-1250H 65
15									
20									
25									
35	20	25	35						
65									
65									
65		50	70		50	70	60	70	65
65			70			70		70	
65		50	70		50	70	60	70	65
65			70			70		70	
		50	70		50	70	60	70	65
			70			70		70	
					50	70			
						70			
								70	