



# **TS series human-machine interface**

User manual [Communication]

WUXI XINJE ELECTRIC CO., LTD.

Data No. HSC03 20231123 1.3

## Basic notes

- ◆ Thank you for purchasing the Xinje TS series human-machine interface.
- ◆ This manual mainly introduces the TS series human-machine interface and its connection with other devices.
- ◆ Before using the product, please read this manual carefully and make the wiring on the premise of fully understanding the content of the manual.
- ◆ Introduction to software and programming, please refer to relevant manuals.
- ◆ Please deliver this manual to the end user.

## User instructions

- ◆ Only operators with a certain level of electrical knowledge can perform wiring and other operations on the product. If there is any unclear usage, please consult our company's technical personnel.
- ◆ The examples listed in manuals and other technical materials are for user understanding and reference only, and don't guarantee certain actions.
- ◆ When using this product in combination with other products, please confirm if it complies with relevant specifications, principles, etc.
- ◆ When using this product, please confirm whether it meets the requirements and is safe.
- ◆ Please set up your own backup and safety functions to avoid potential machine malfunctions or losses caused by product malfunctions.
- ◆ Please avoid using human-machine interfaces in environments with high radiation and strong magnetic fields to avoid interference.

## Statement of responsibility

- ◆ Although the contents of the manual have been carefully checked, errors are inevitable, and we can't guarantee complete consistency.
- ◆ We will often check the contents of the manual and correct them in subsequent versions. We welcome your valuable comments.
- ◆ Please understand that the contents described in the manual are subject to change without notice.

## Contact method

For instructions on TS software and programming, as well as TS hardware, please refer to the following manual, which can be downloaded from: <https://www.xinje.com/>.

- ◆ 《TouchWin Pro Editing Software User Manual》
- ◆ 《TS series human-machine interface user manual [hardware section]》

WUXI XINJE ELECTRIC CO., LTD. All rights reserved

This material and its contents shall not be copied, transmitted or used without explicit written permission. Violators shall be liable for the losses caused. All rights provided in the patent license and registration including utility modules or designs are reserved.

February, 2022

---

# Catalog

<b>1 DESCRIPTION</b> .....	<b>1</b>
1.1 SERIAL PORT OF HMI .....	1
1.1.1 COM1 port .....	1
1.1.2 COM2 port .....	5
1.1.3 Ethernet port .....	5
1.2 COMMUNICATION PRECAUTIONS .....	9
1.2.1 Selection of communication driver (protocol) .....	9
1.2.2 Communication cable production .....	10
1.2.3 Communication parameter description .....	11
<b>2 XINJE PLC CONNECTION INSTRUCTIONS</b> .....	<b>13</b>
2.1 XINJE XC SERIES PLC .....	14
2.1.1 Device type .....	14
2.1.2 Parameters .....	14
2.1.3 Cable making .....	15
2.1.4 Device address .....	16
2.2 XINJE XD/XL/XG SERIES PLC .....	17
2.2.1 Device type .....	17
2.2.2 Parameters .....	17
2.2.3 Cable making .....	18
2.2.4 Device address .....	19
2.3 XINJE XD/XL/XG (ETHERNET) SERIES PLC( MODBUS TCP ) .....	21
2.3.1 Device type .....	21
2.3.2 Parameters .....	21
2.3.3 Cable making .....	24
2.3.4 Device address .....	25
2.4 XINJE XS SERIES (CODESYS) - LABEL COMMUNICATION .....	27
2.4.1 Device type .....	27
2.4.2 Parameters .....	27
2.4.3 Cable making .....	34
2.4.4 Support data types .....	35
<b>3 SIEMENS PLC CONNECTION INSTRUCTIONS</b> .....	<b>37</b>
3.1 SIEMENS S7-200 SERIES PLC .....	37
3.1.1 Device type .....	37
3.1.2 Parameters .....	37
3.1.3 Cable making .....	39
3.1.4 Device address .....	39
3.2 SIEMENS S7-200 SMART SERIES ETHERNET .....	40
3.2.1 Device type .....	40
3.2.2 Parameters .....	40
3.2.3 Cable making .....	42
3.2.4 Device address .....	42
3.3 SIEMENS S7-300 SERIES ETHERNET .....	44
3.3.1 Device type .....	44
3.3.2 Parameters .....	44

3.3.3 Cable making.....	46
3.3.4 Device address.....	46
3.4 SIEMENS S7-1200/1500 SERIES ETHERNET.....	48
3.4.1 Device type.....	48
3.4.2 Parameters.....	48
3.4.3 Cable making.....	54
3.4.4 Device address.....	55
3.5 SIEMENS LOGO (MODBUS TCP).....	56
3.5.1 Device type.....	56
3.5.2 Parameters.....	56
3.5.3 Cable making.....	57
3.5.4 Device address.....	58
<b>4 MODBUS DEVICE CONNECTION INSTRUCTIONS . . . . .</b>	<b>59</b>
4.1 MODBUS RTU( MASTER ).....	59
4.1.1 Device type.....	59
4.1.2 Parameters.....	59
4.1.3 Cable making.....	60
4.1.4 Device address.....	61
4.2 MODBUS ASCII( MASTER ).....	62
4.2.1 Device type.....	62
4.2.2 Parameters.....	62
4.2.3 Cable making.....	63
4.2.4 Device address.....	63
4.3 MODBUS RTU (SLAVE).....	64
4.3.1 Device type.....	64
4.3.2 Parameters.....	64
4.3.3 Cable making.....	65
4.3.4 Device address.....	65
4.4 MODBUS TCP( MASTER ).....	67
4.4.1 Device type.....	67
4.4.2 Parameters.....	67
4.4.3 Cable making.....	69
4.4.4 Device address.....	70
4.5 MODBUS TCP (SLAVE).....	71
4.5.1 Device type.....	71
4.5.2 Parameters.....	71
4.5.3 Cable making.....	71
4.5.4 Device address.....	72
<b>5 MITSUBISHI PLC CONNECTION INSTRUCTIONS . . . . .</b>	<b>73</b>
5.1 MITSUBISHI FX SERIES.....	73
5.1.1 Device type.....	73
5.1.2 Parameters.....	73
5.1.3 Cable making.....	74
5.1.4 Device address.....	75
5.2 MITSUBISHI FX3U/G SERIES.....	76
5.2.1 Device type.....	76
5.2.2 Parameters.....	76
5.2.3 Cable making.....	77

5.2.4 Device address .....	77
5.3 MITSUBISHI FX5U SERIES .....	79
5.3.1 Device type .....	79
5.3.2 Parameters .....	79
5.3.3 Cable making .....	82
5.3.4 Device address .....	82
5.4 MITSUBISHI Q/L SERIES .....	84
5.4.1 Device type .....	84
5.4.2 Parameters .....	84
5.4.3 Cable making .....	87
5.4.4 Device address .....	88
5.5 MITSUBISHI Q02H SERIES .....	90
5.5.1 Device type .....	90
5.5.2 Parameters .....	90
5.5.3 Cable making .....	93
5.5.4 Device address .....	94
5.6 MITSUBISHI Q/L SERIES ETHERNET .....	96
5.6.1 Device type .....	96
5.6.2 Parameters .....	96
5.6.3 Cable making .....	99
5.6.4 Device address .....	99
5.7 MITSUBISHI FX5U SERIES (SLMP) .....	101
5.7.1 Device type .....	101
5.7.2 Parameters .....	101
5.7.3 Cable making .....	104
5.7.4 Device address .....	105
<b>6 DELTA PLC CONNECTION INSTRUCTIONS .....</b>	<b>106</b>
6.1 DELTA AS SERIES .....	106
6.1.1 Device type .....	106
6.1.2 Parameters .....	106
6.1.3 Cable making .....	110
6.1.4 Device address .....	110
6.2 DELTA AS SERIES ETHERNET .....	111
6.2.1 Device type .....	111
6.2.2 Parameters .....	111
6.2.3 Cable making .....	113
6.2.4 Device address .....	114
6.3 DELTA DVP SERIES .....	115
6.3.1 Device type .....	115
6.3.2 Parameters .....	115
6.3.3 Cable making .....	116
6.3.4 Device address .....	116
<b>7 KEYENCE PLC CONNECTION INSTRUCTIONS .....</b>	<b>117</b>
7.1 KEYENCE KV SERIES .....	117
7.1.1 Device type .....	117
7.1.2 Parameters .....	117
7.1.3 Cable making .....	118
7.1.4 Device address .....	120

7.2 KEYENCE KV SERIES ETHERNET .....	121
7.2.1 Device type .....	121
7.2.2 Parameters .....	121
7.2.3 Cable making .....	121
7.2.4 Device address .....	122
<b>8 LG PLC CONNECTION INSTRUCTIONS .....</b>	<b>124</b>
8.1 LG MASTER-K 80/120 SERIES ( CNET ) .....	124
8.1.1 Device type .....	124
8.1.2 Parameters .....	124
8.1.3 Cable making .....	127
8.1.4 Device address .....	127
8.2 LG XBC SERIES .....	129
8.2.1 Device type .....	129
8.2.2 Parameters .....	129
8.2.3 Cable making .....	132
8.2.4 Device address .....	133
8.3 LG XEC SERIES ( CNET ) .....	134
8.3.1 Device type .....	134
8.3.2 Parameters .....	134
8.3.3 Cable making .....	135
8.3.4 Device address .....	135
8.4 LG XGT/XGK/XGB SERIES .....	136
8.4.1 Device type .....	136
8.4.2 Parameters .....	136
8.4.3 Cable making .....	137
8.4.4 Device address .....	138
8.5 LG XEC SERIES ETHERNET .....	140
8.5.1 Device type .....	140
8.5.2 Parameters .....	140
8.5.3 Cable making .....	141
8.5.4 Device address .....	142
<b>9 VIGOR PLC CONNECTION INSTRUCTIONS .....</b>	<b>144</b>
9.1 VIGOR VB/VH SERIES .....	144
9.1.1 Device type .....	144
9.1.2 Parameters .....	144
9.1.3 Cable making .....	145
9.1.4 Device address .....	146
9.2 VIGOR VS SERIES .....	147
9.2.1 Device type .....	147
9.2.2 Parameters .....	147
9.2.3 Cable making .....	148
9.2.4 Device address .....	149
<b>10 OMRON PLC CONNECTION INSTRUCTIONS .....</b>	<b>150</b>
10.1 OMRON CP/CJ/CS SERIES .....	150
10.1.1 Device type .....	150
10.1.2 Parameters .....	150
10.1.3 Cable making .....	152

10.1.4 Device address .....	153
<b>11 INOVANCE PLC CONNECTION INSTRUCTIONS .....</b>	<b>155</b>
11.1 INOVANCE H1U/H2U SERIES .....	155
11.1.1 Device type .....	155
11.1.2 Parameters .....	155
11.1.3 Cable making .....	157
11.1.4 Device address .....	157
11.2 INOVANCE H3U SERIES .....	159
11.2.1 Device type .....	159
11.2.2 Parameters .....	159
11.2.3 Cable making .....	160
11.2.4 Device address .....	160
11.3 INOVANCE H5U SERIES .....	161
11.3.1 Device type .....	161
11.3.2 Parameters .....	161
11.3.3 Cable making .....	162
11.3.4 Device address .....	162
11.4 INOVANCE AM600 SERIES .....	163
11.4.1 Device type .....	163
11.4.2 Parameters .....	163
11.4.3 Cable making .....	164
11.4.4 Device address .....	164
11.5 INOVANCE AM600 SERIES ETHERNET .....	166
11.5.1 Device type .....	166
11.5.2 Parameters .....	166
11.5.3 Cable making .....	168
11.5.4 Device address .....	169
<b>12 FATEK PLC CONNECTION INSTRUCTIONS .....</b>	<b>170</b>
12.1 FATEK MU/MA SERIES .....	170
12.1.1 Device type .....	170
12.1.2 Parameters .....	170
12.1.3 Cable making .....	171
12.1.4 Device address .....	172
<b>13 PANASONIC PLC CONNECTION INSTRUCTIONS .....</b>	<b>174</b>
13.1 PANASONIC FP0/FP1 SERIES .....	174
13.1.1 Device type .....	174
13.1.2 Parameters .....	174
13.1.3 Cable making .....	176
13.1.4 Device address .....	177
13.2 PANASONIC FP-XH SERIES .....	178
13.2.1 Device type .....	178
13.2.2 Parameters .....	178
13.2.3 Cable making .....	179
13.2.4 Device address .....	179
<b>14 AB PLC CONNECTION INSTRUCTIONS .....</b>	<b>180</b>
14.1 AB MICROLOGIX/SLC SERIES .....	180

14.1.1 Device type .....	180
14.1.2 Parameters .....	180
14.1.3 Cable making .....	182
14.1.4 Device address .....	182
<b>15 KOYO PLC CONNECTION INSTRUCTIONS .....</b>	<b>184</b>
15.1 KOYO S SERIES .....	184
15.1.1 Device type .....	184
15.1.2 Parameters .....	184
15.1.3 Cable making .....	186
15.1.4 Device address .....	187
15.2 KOYO DIRECT SERIES .....	188
15.2.1 Device type .....	188
15.2.2 Parameters .....	188
15.2.3 Cable making .....	189
15.2.4 Device address .....	190
<b>16 ABB PLC CONNECTION INSTRUCTIONS .....</b>	<b>191</b>
16.1 ABB AC500 SERIES .....	191
16.1.1 Device type .....	191
16.2.2 Parameters .....	191
16.3.3 Cable making .....	192
16.3.4 Device address .....	193
<b>17 EMERSON PLC CONNECTION INSTRUCTIONS .....</b>	<b>194</b>
17.1 EMERSON EC20 SERIES .....	194
17.1.1 Device type .....	194
17.1.2 Parameters .....	194
17.1.3 Cable making .....	196
17.1.4 Device address .....	197
<b>18 SCHNEIDER PLC CONNECTION INSTRUCTIONS .....</b>	<b>198</b>
18.1 SCHNEIDER MICRO/NEZA/TWIDO SERIES .....	198
18.1.1 Device type .....	198
18.1.2 Parameters .....	198
18.1.3 Cable making .....	201
18.1.4 Device address .....	201
<b>19 HAIWELL PLC CONNECTION INSTRUCTIONS .....</b>	<b>202</b>
19.1 HaiWELL ( MODBUS RTU ) SERIES .....	202
19.1.1 Device type .....	202
19.1.2 Parameters .....	202
19.1.3 Cable making .....	203
19.1.4 Device address .....	203
19.2 HaiWELL BUS TCP SERIES .....	205
19.2.1 Device type .....	205
19.2.2 Parameters .....	205
19.2.3 Cable making .....	207
19.2.4 Device address .....	207
<b>20 OPC UA DEVICE CONNECTION INSTRUCTIONS .....</b>	<b>209</b>

---

20.1 OPC UA CLIENT—LABEL COMMUNICATION .....	209
20.1.1 Device type .....	209
20.1.2 Parameters .....	209
20.1.3 Cable making .....	217
20.1.4 Support data types .....	218
<b>21 CODESYS SERIES PLC CONNECTION INSTRUCTIONS .....</b>	<b>219</b>
21.1 CODESYS PLC SERIES—MODBUS RTU/MODBUS TCP PROTOCOL .....	219
21.1.1 Device type .....	219
21.1.2 MODBUS RTU Parameters .....	219
21.1.3 MODBUS TCPParameters .....	221
21.1.4 Cable making .....	223
21.2 CODESYS PLC SERIES—LABEL COMMUNICATION .....	224
21.2.1 Device type .....	224
21.2.2 Parameters .....	224
21.2.3 Cable making .....	231
21.2.4 Support data types .....	232

# 1 Description

This chapter will introduce the serial port of HMI.

## 1.1 Serial port of HMI

Series	COM1port			COM2 port			Expand port	Ethernet port <sup>※1</sup>
	RS232	RS485	RS422	RS232	RS485	RS422	RS485	RJ45
TS3 Series	√	√		√	√	√		

※1:TS3 Series-E model with Ethernet port.

The following figure illustrates the communication interface of the new TS3-700-E as an example (Note: the old TS3 series hardware has a dial switch):

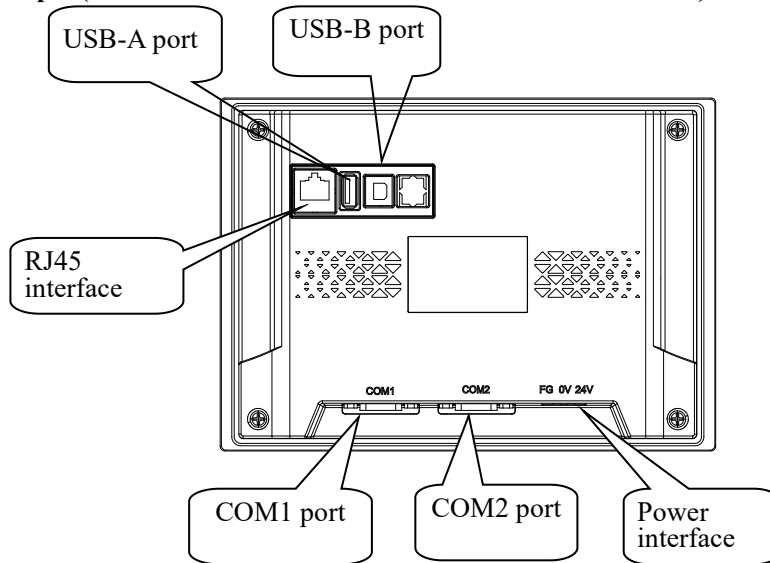

### 1.1.1 COM1 port

Com1 port:

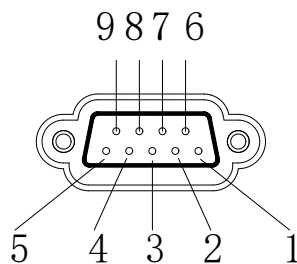

Pin	Name	Explanation
1	NC	Vacant
2	RXD	RS232 receive
3	TXD	RS232 send
4	A	RS485 +
5	GND	Ground
6	NC	Vacant
7	B	RS485 -
8	NC	Vacant
9	NC	Vacant

**Notes:** The TS3 series human-machine interface COM1 port doesn't support RS422 and cannot directly communicate with Mitsubishi FX/FX3U/FX3G series CPU ports and other RS422 devices. If communication with Mitsubishi FX/FX3U/FX3G series PLC is required, the PLC can be equipped with a 232/485BD board or use Mitsubishi original programming cables.

1. To create a new project, on the next page after selecting the display model, under the "COM1 port" option, select the corresponding PLC brand through the drop-down button, as follows:

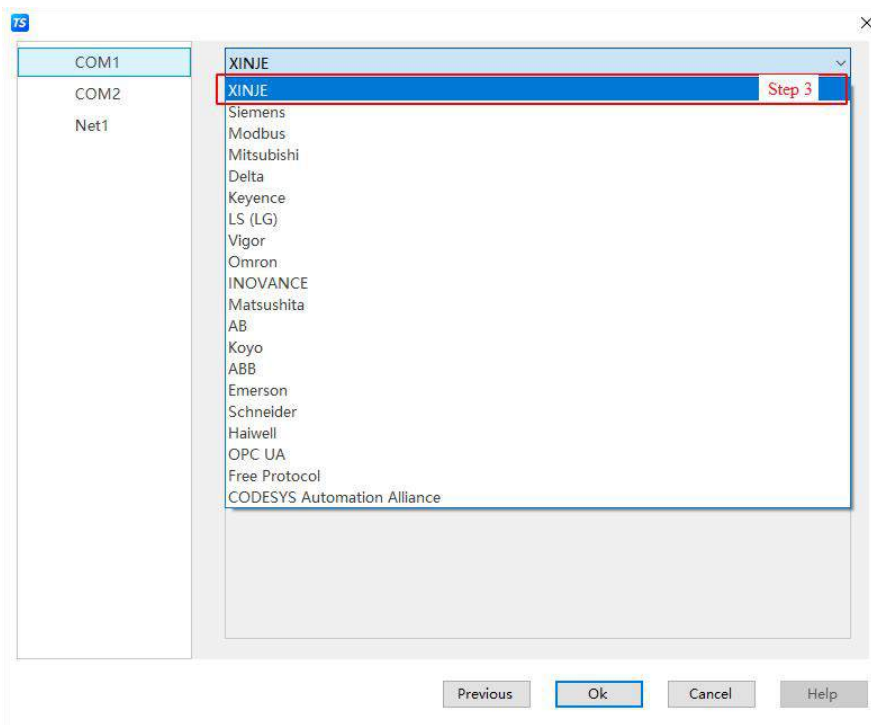
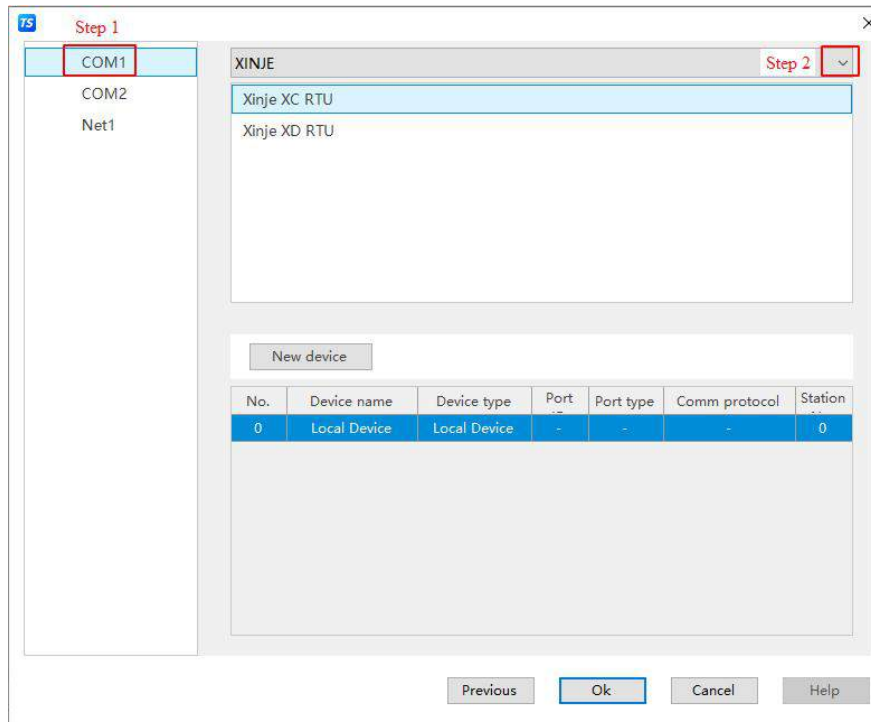

Select the corresponding PLC model in the list, click "New Device", and the communication settings window will automatically pop up, as shown in the following figure:

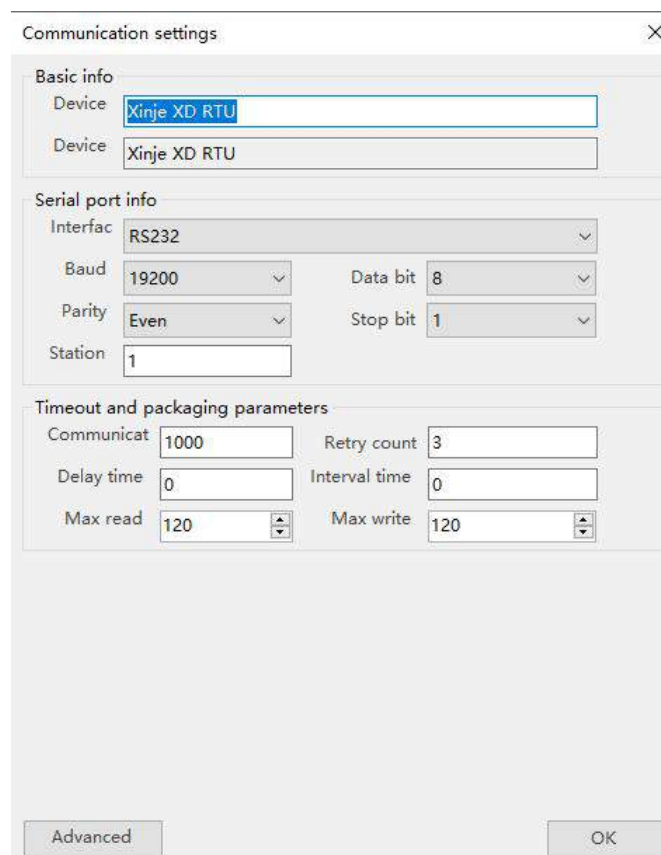
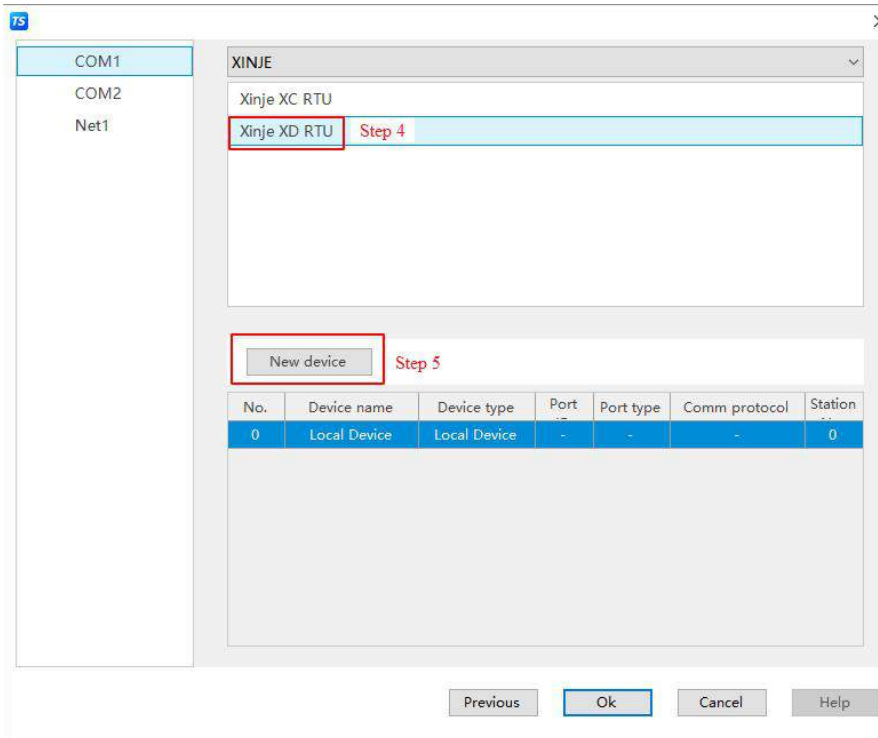

You can manually modify the device name. After confirming that the parameters are correct, click "OK" to add 1 device information. Click "OK" to complete the process. If you need to control multiple devices, you can continue adding them according to this step.

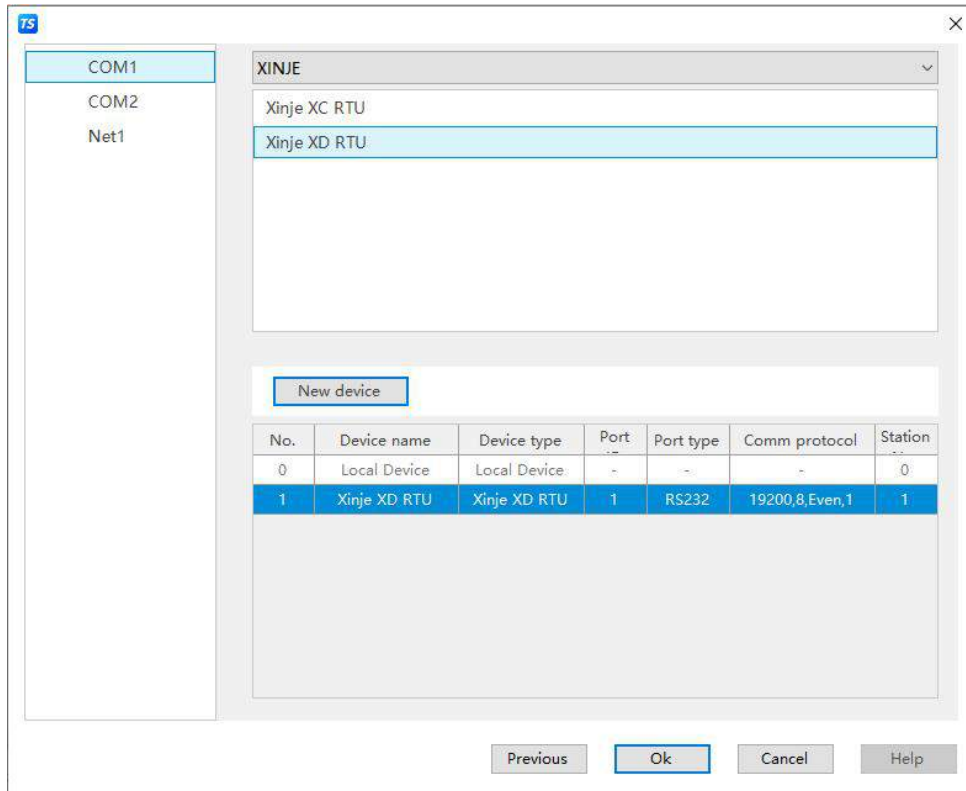

2. The edited project can be viewed or modified by clicking on "File / System Settings / Device / Serial Device /Download Port" to view or modify PLC communication parameters. To change the PLC type, right-click on the added device to delete it, and then select the desired device again and click "New Device". It's recommended not to switch the PLC type directly. If the PLC type has already been switched, please check the address and station number of each component again.

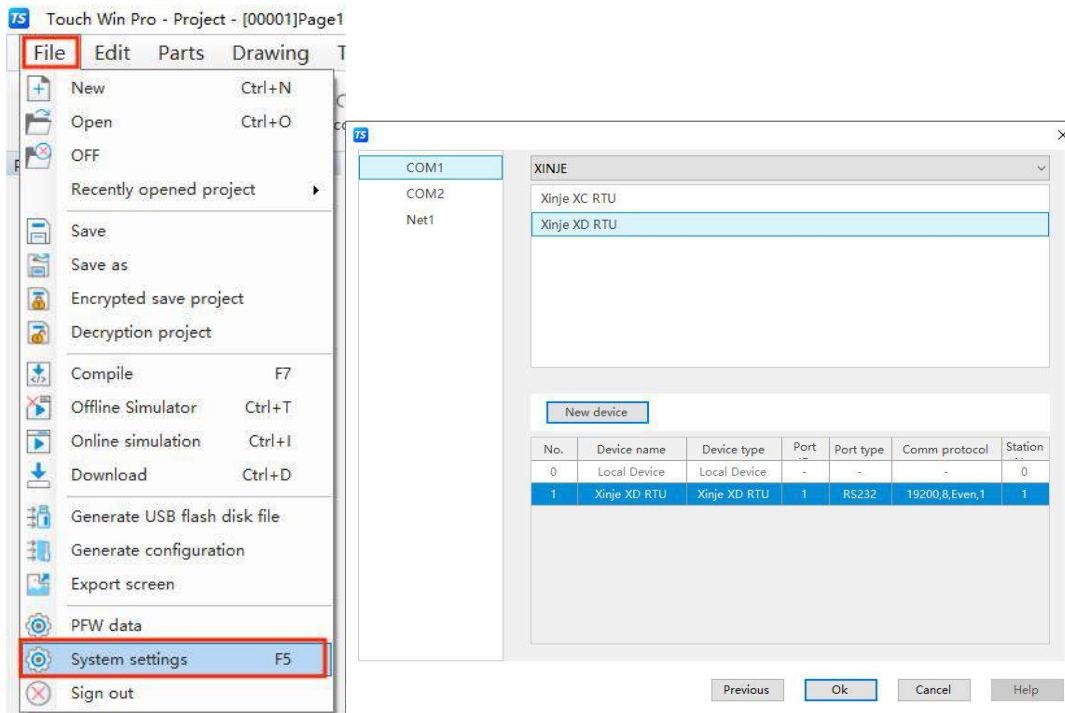

## 1.1.2 COM2 port

PLC port:

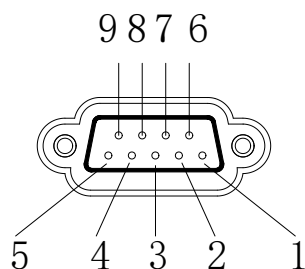

Pin	Name	Explanation
1	TD+	RS422 send +
2	RXD	RS232 receive
3	TXD	RS232 send
4	A	RS485 +
5	GND	Ground
6	TD-	RS422 send -
7	B	RS485 -
8	RD-	RS422 receive -
9	RD+	RS422 receive +

RS422:  
1, 5, 6, 8, 9

**Note:** In practical applications, please refer to Chapter 2 for the production of communication cables, and refer to Section 1.1.1 for COM1 port parameter settings for the selection and modification of communication equipment.

## 1.1.3 Ethernet port

RJ45 Ethernet port:

Pin	Color	Definition	Explanation
1	Orange white	TXD+	Data send+
2	Orange	TXD-	Data send-
3	Green white	RXD+	Data receive+
4	Blue	-	-
5	Blue white	-	-
6	Green	RXD-	Data receive-
7	Brown white	-	-
8	Brown	-	-

**Note:** The TS3 series only comes with an Ethernet port for the - E model.

1. New project, select the touch screen model to be used in the "Display" list, and be sure to select the - E model:

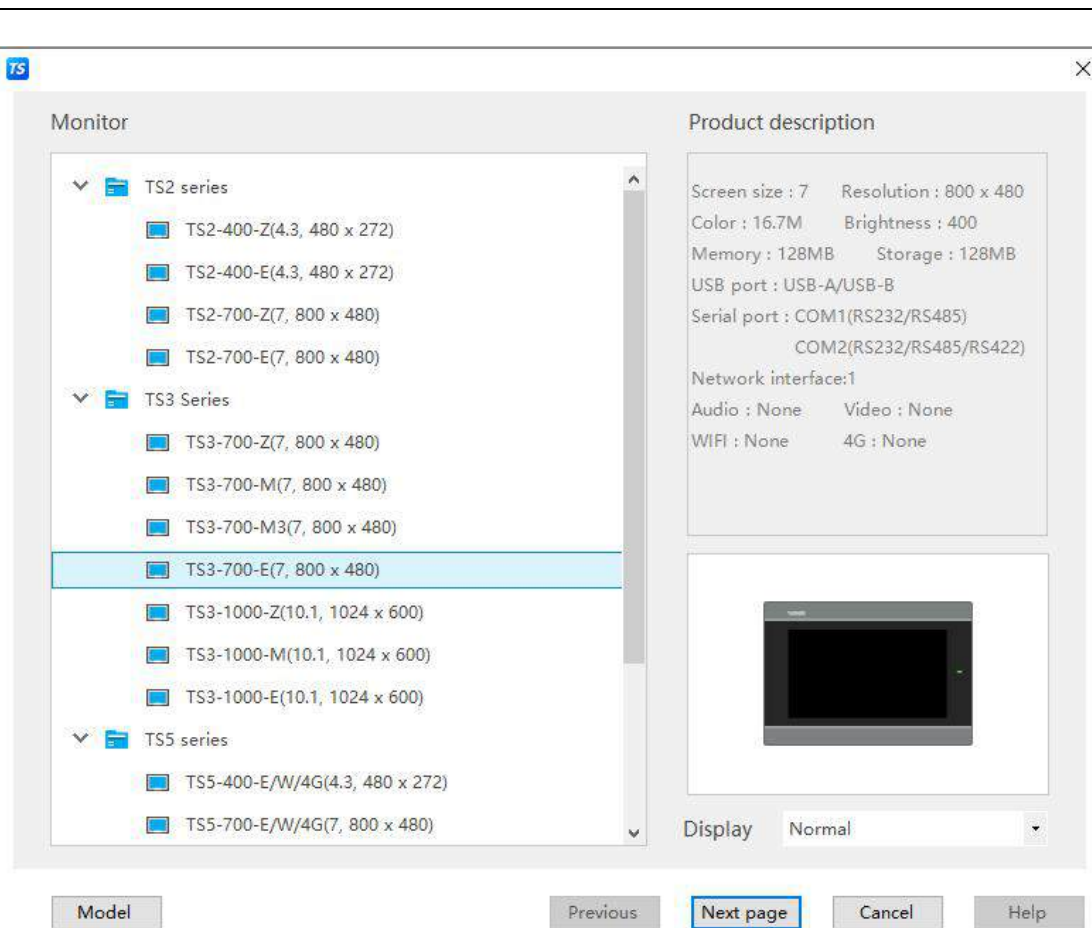

2. Next, in the left serial port list, select "Net1". In the right model list, first click on the drop-down box, select the brand that needs to be connected in the drop-down box, then select the PLC series or model that needs to be connected in the model list, and finally click "New Device". The steps are shown in the following figure:

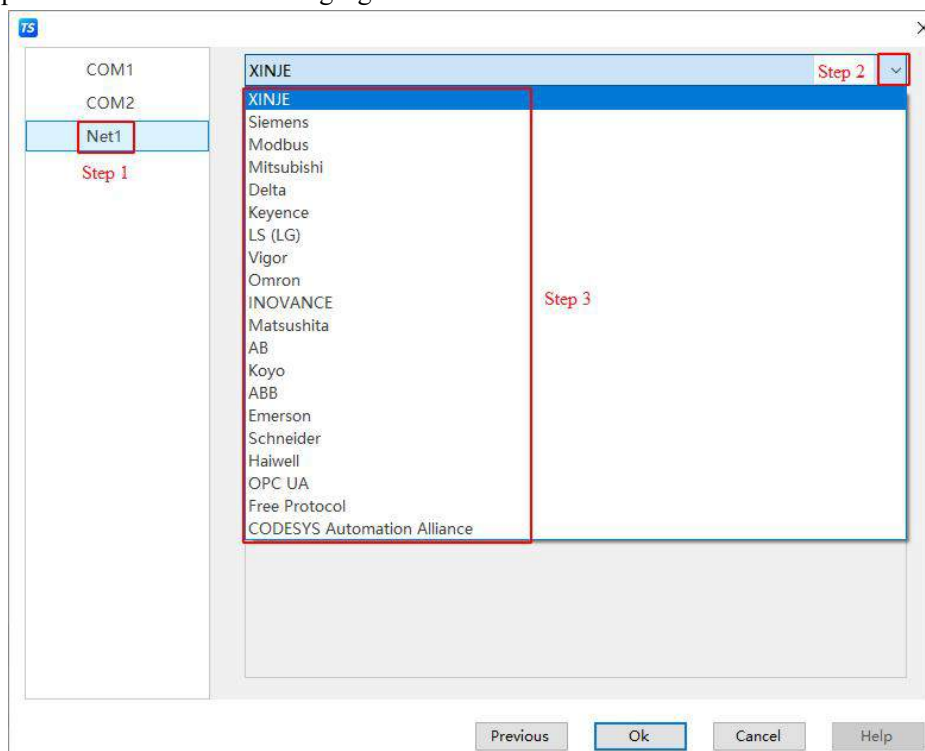

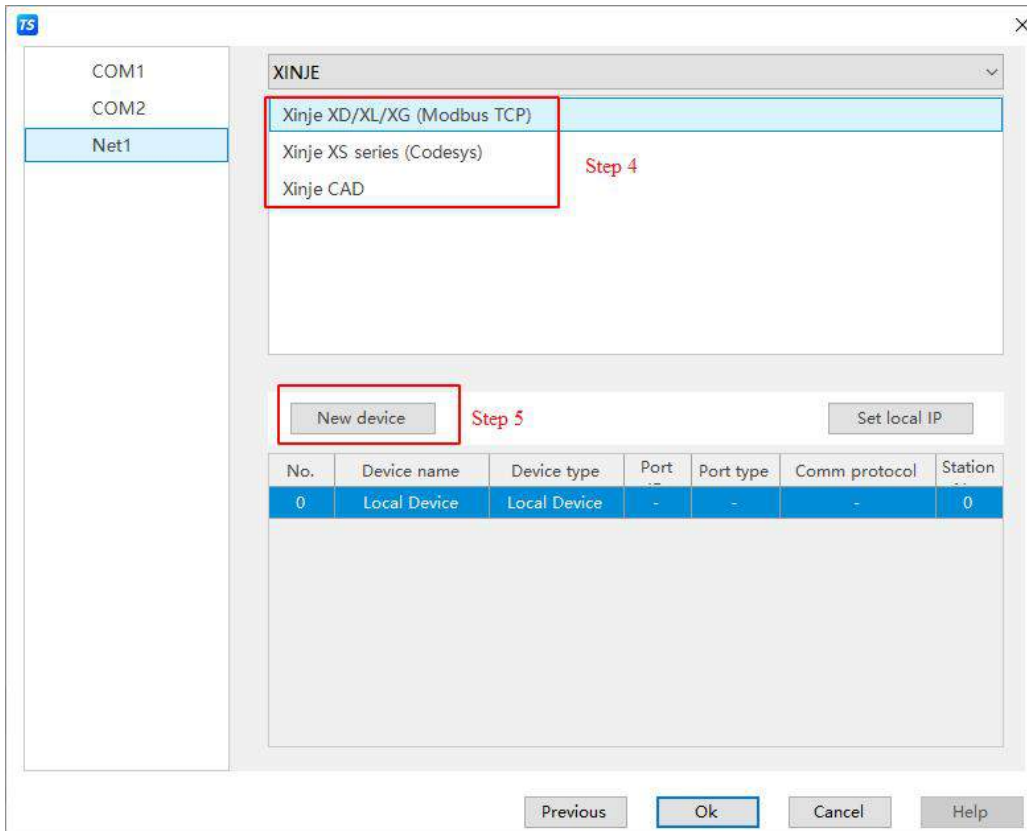

3. After selecting the "New Device" option, a communication settings window will automatically pop up, where you can configure communication parameters, set device IP addresses, and device names, as shown in the following figure:

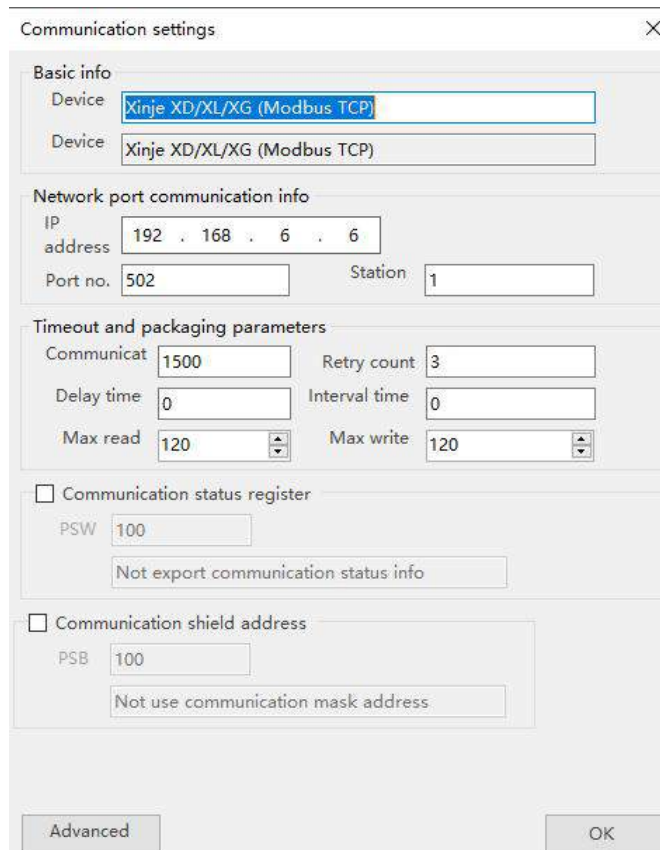

4. Click the "Set Local IP" button to set the communication IP address for the touch screen. After setting it, click "OK" to exit.

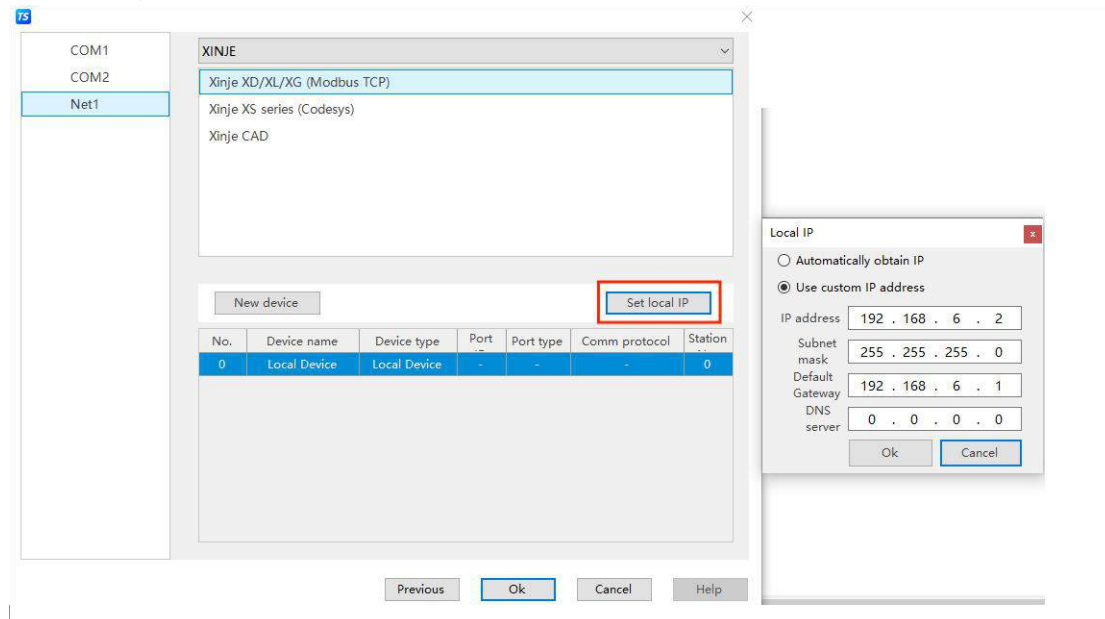

**Notes:**

- (1) At present, touch screens can only connect to local area networks and don't support wide area networks.**
- (2) At present, the Ethernet protocol only supports the protocols listed in the above figure, while other protocols are constantly being developed.**

## 1.2 Communication precautions

### 1.2.1 Selection of communication driver (protocol)

Before communication, select the corresponding driver (protocol) before programming. You can refer to the following instructions to select the driver (protocol):

1. Select the brand and series (model) of the device directly from the software device list.

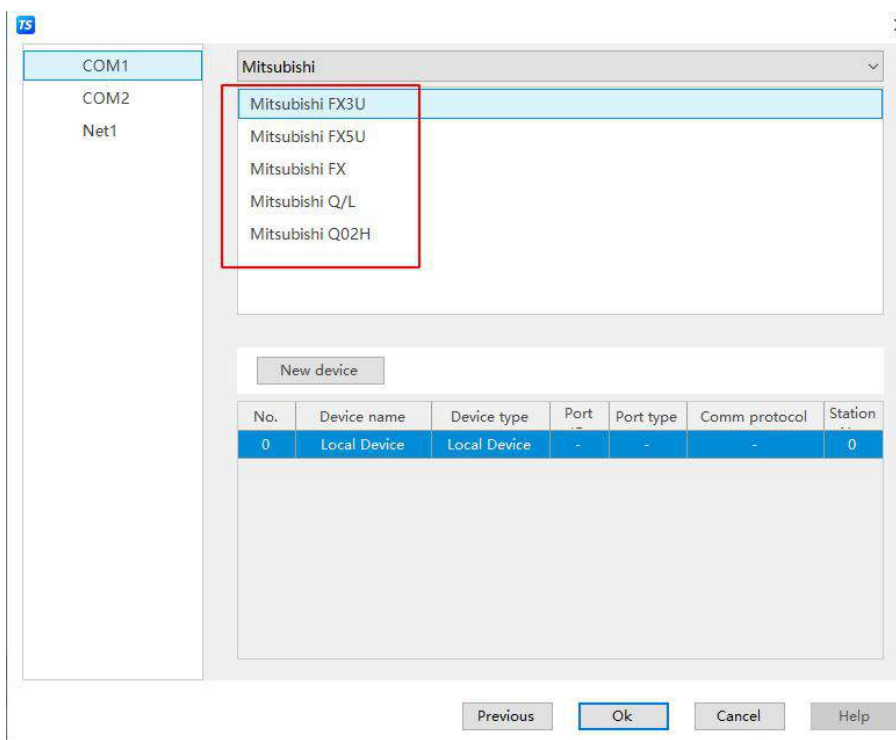
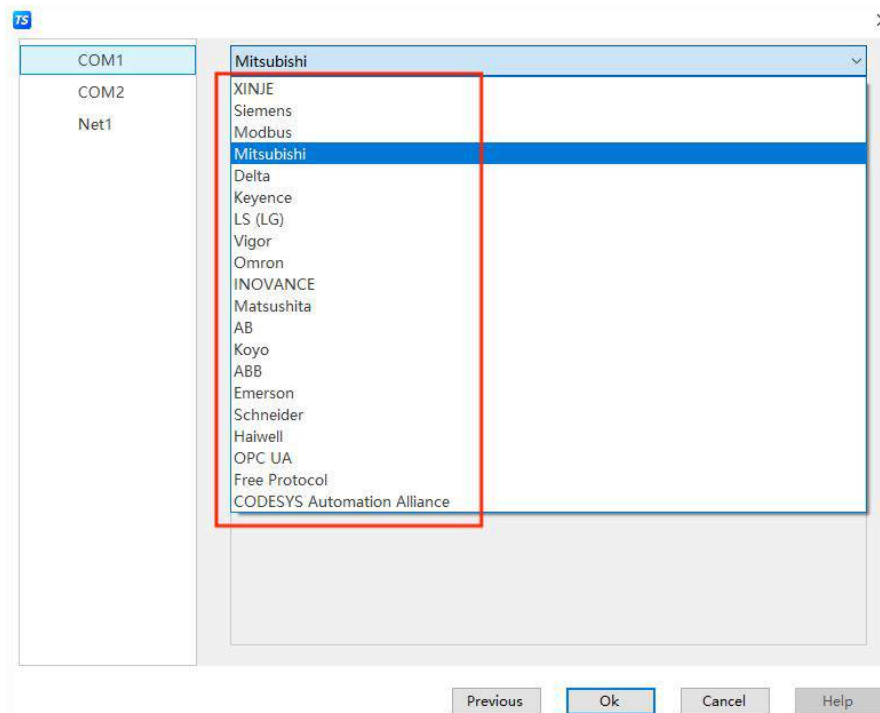

2. If this device is not listed, check if it supports Modbus RTU protocol or Modbus ASCII protocol.

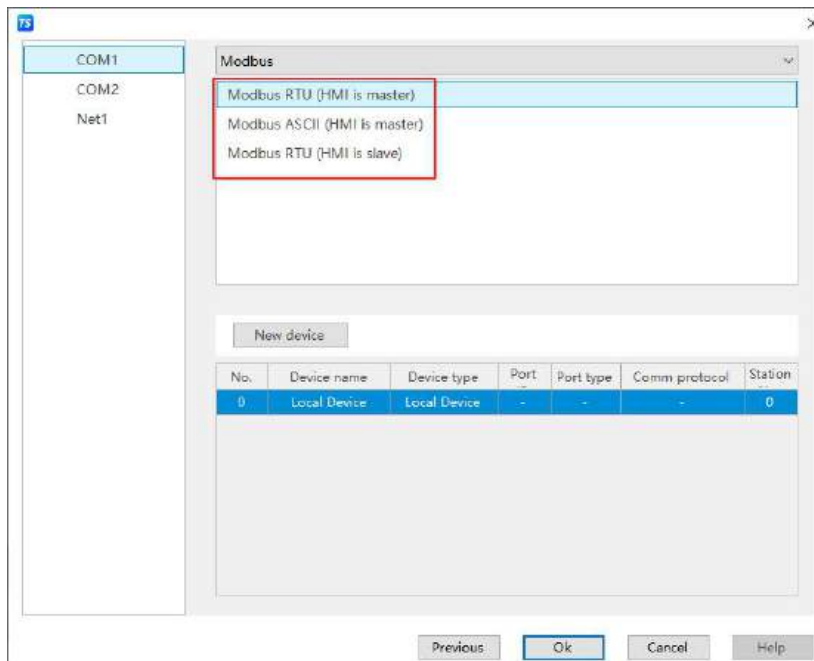

3. If neither of the above two options are met, you can choose to use the C function block in the software for free communication.

**Note: When communicating with the lower computer through the C function block, the Modbus slave device (Slave display) driver (protocol) is not available. Other protocols can be freely selected, as long as the communication parameters are kept consistent.**

### 1.2.2 Communication cable production

1. The company's existing communication cables are listed below and can be ordered directly.

PLC	Cable type	Notes
XINJE	XVP cable (XP3-16)	
Delta	DVP cable	
Omron	CPM cable	
Mitsubishi FX5U	FX5U cable	
Mitsubishi FX	FX cable	
Siemens	S7-200( OP )	Black
	S7 cable( HMI )	White
Schneider	TwidoOP cable( OP )	Black
	TwidoTP cable( HMI )	White
Fatek	Fatek cable	
LG	LG cable	Programming port communication
	Cnet cable	Cnet communication
Matsushita	Matsushita cable	
Koyo	SM cable	

2. If there is no required communication cable in the previous list, please refer to the cable production in the next chapter and make your own communication cable.

### 1.2.3 Communication parameter description

Communication settings

Basic info

Device: Modbus RTU (HMI is master)

Device: Modbus RTU (HMI is master)

Serial port info

Interfac: RS485

Baud: 9600 Data bit: 8

Parity: Even Stop bit: 1

Station: 1

Timeout and packaging parameters

Communicat: 1000 Retry count: 3

Delay time: 0 Interval time: 0

Max read: 120 Max write: 120

Advanced OK

- ◆ The baud rate, data bits, check bits, stop bits, and station numbers should be consistent with the PLC.
- ◆ Communication timeout: used to set the communication timeout time. For example, if the timeout time is set to 100ms, when the touch screen issues a command and the slave doesn't return data within 100ms, the touch screen will determine it as communication timeout.
- ◆ Repetition count: defaults to 3. When the touch screen sends a command, the slave doesn't respond (communication timeout) or responds incorrectly (communication error). After repeating it continuously for 3 times, the touch screen considers it a communication failure and continues to access the next parameter.
- ◆ Delay time: used to set the delay before sending the touch screen, with a default value of 0, which means there is no delay.
- ◆ Interval time: refers to the maximum character interval time for the slave to respond to data after the touch screen sends instructions. It's set to 0 by default, which means default parameters are used based on system and protocol differences. Note: It's not recommended to modify the slave response data arbitrarily, provided that it complies with protocol specifications.
- ◆ Maximum read/write word count: used to set the data length for each packet communication.

When using Modbus communication, clicking on "Advanced Communication Settings" can enter the advanced communication parameter settings, as shown in the following figure:

Communication function			
only	YES	Address radix	0
Function	Parity code	Check data	HL (high byte, low b
High/low byte			
16-bit	AB	16-bit char	BA
32-bit	ABCD	32-bit char	BADC
64-bit	ABCDEFGH	64-bit char	BADCFEHG

- ◆ Multiple register write only: used to set multiple register write operations.
- ◆ Address base: used to set the starting value of the address. There are two options, 0 and 1, with a default value of 0, which means the address is not offset and starts from 0. If the address base is set to 1, the communication will be participated in by subtracting 1 from the address set by the control. For example, when the control address is set to 1, it's actually participating in communication with an address of 0.
- ◆ Function code verification: Select whether to verify the function code. If you choose to verify the function code, you need to set the byte order of the subsequent verification data and choose the verification sequence that is suitable for the current device communication.
- ◆ High/Low Bytes: When the data monitoring and device values are inconsistent, observe whether it's the reason for the incorrect high and low words, and set the correct order suitable for the current device here.

For Modbus protocol communication, when communication is not smooth, a communication flag can be placed to check the cause of communication abnormalities. Four data display boxes are placed in the screen, with addresses of :

COM1 port communication flags: SPSW44~SPSW46

COM2 port communication flags: SPSW48~SPSW50

The corresponding meaning is: number of successful communication attempts, number of communication errors, and number of communication timeouts.

During normal communication, the number of successful communications accumulates continuously, while the other three are all 0.

---

## 2 Xinje PLC Connection Instructions

This chapter will introduce the connection between PLC and HMI.

**Notes:**

- (1) The Xinje TS3 series touch screen supports a maximum baud rate of 187.5K.**
- (2) During communication, please don't plug or unplug cables with power, as it may cause damage to the device's serial port.**
- (3) Upgrade of touch screen software version, there may be some changes in the communication protocol device address range. The device address range in the software shall prevail.**

## 2.1 XINJE XC series PLC

### 2.1.1 Device type

Series	CPU	Connected module	Port	Cable making	PLC model in Touchwin software
XC	XC1	CPU direct connection	RS232	Fig1 or Fig2	Xinje XC series
	XC2		RS485	Fig 3	
	XC3	XC-COM-BD (Communication extension board)	RS232	Fig 4	
	XC5		RS485	Fig 5	
	XCC				
	XCM				

### 2.1.2 Parameters

#### 1.HMI settings:

Parameter	Recommend settings	Choices of settings	Note
PLC type	XC series	XC series / Modbus RTU (HMI is master)	None
Port	RS232	RS232 or RS485	
Data bit	8		
Stop bit	1		
Parity	Even parity		
Baud rate	19200	4800/38400/9600/115200/19200/187500	
Station No.	1	0~255	

Default communication parameters for Xinje XC series protocol:

2. PLC settings:

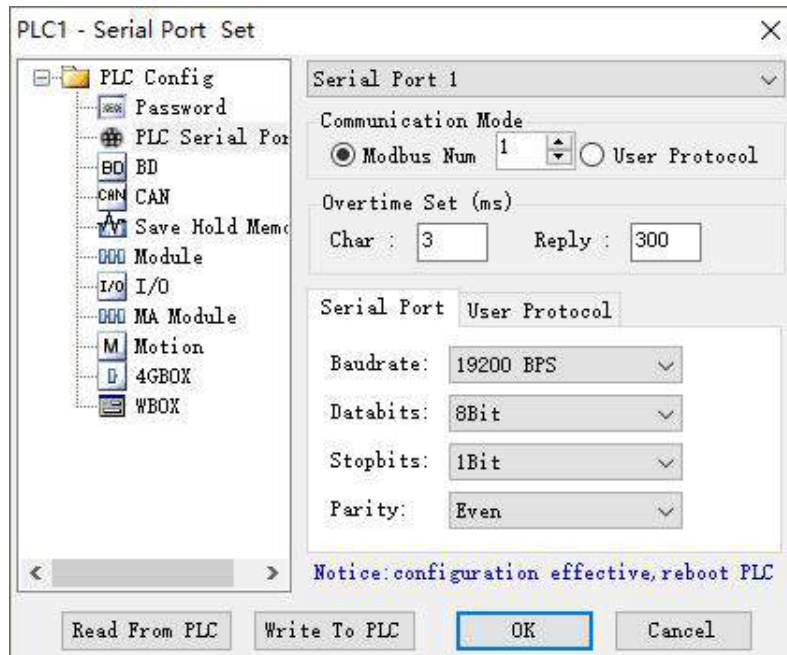

2.1.3 Cable making

1. Connect to XC series PLC CPU (RS232 port)

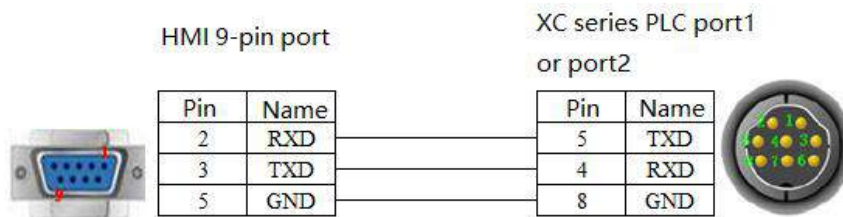

( Fig 1 )

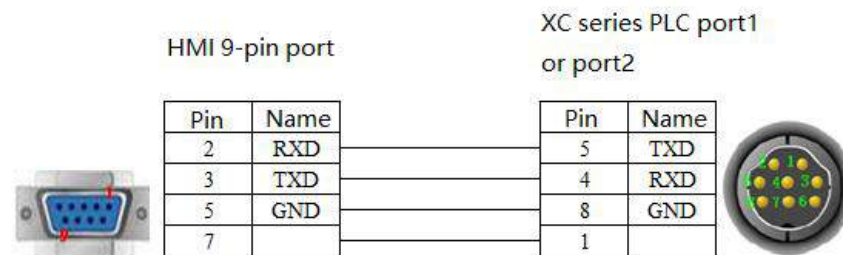

( Fig 2 )

**Note:** XP3-16 must use the communication line shown in Fig2 (XVP line) when downloading program.

2. Connect to XC series PLC CPU (RS485 port)

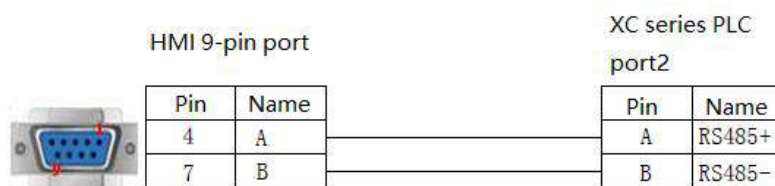

( Fig 3 )

3. Connect via XC-COM-BD (RS232)

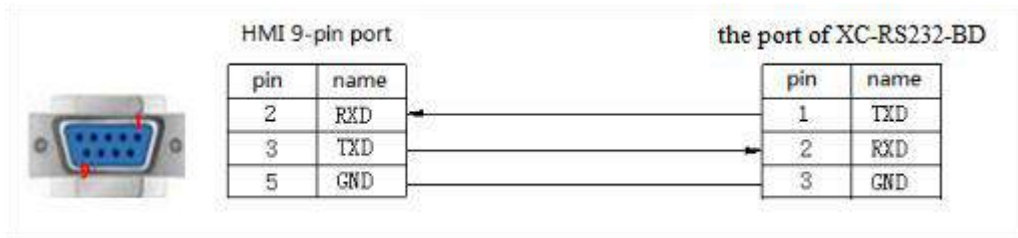

( Fig 4 )

4. Connect via XC-COM-BD (RS485)

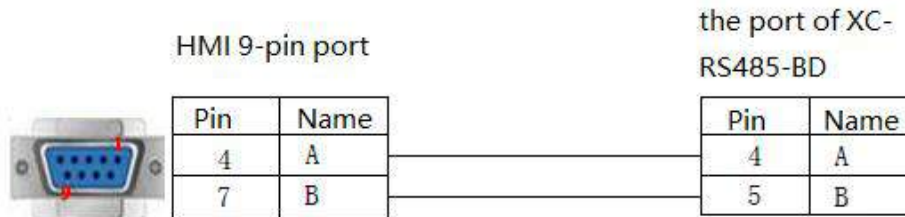

( Fig 5 )

2.1.4 Device address

PLC address	Range	Data type	Explanation
X	0~731	Bit	External External input coil coil
Y	0~731	Bit	External External input coil coil
M	0~7999	Bit	Internal coil
S	0~1023	Bit	Internal coil
M8XXX	0~767	Bit	Internal special register
T	0~639	Bit	Timer
C	0~639	Bit	Counter
D	0~7999	Word/DWord	Data register
TD	0~639	Word/DWord	Timer register
CD	0~639	Word/DWord	Counter register
D8XXX	0~2047	Word/DWord	Special register
FD	0~1535	Word/DWord	FlashROM register
FD8XXX	0~2047	Word/DWord	External output coil register
ED	0~36862	Word/DWord	Extend register
DM	0~7984	Word	Data register
DX	0~528	Word	Data register
DY	0~528	Word	Data register
DS	0~1008	Word	Data register
DM8XXX	0~496	Word	Data register
DT	0~603	Word	Data register
DC	0~619	Word	Data register
ID	0~9999	Word/DWord	Analog External input coil
QD	0~9999	Word/DWord	Analog External output coil

## 2.2 XINJE XD/XL/XG series PLC

### 2.2.1 Device type

Series	CPU	Connected module	Port	Cable making	PLC model in Touchwin software
XD/XL/XG	XD/XDM/XDH/ XDC/XL/XG	CPU direct connection	RS232	Fig1 or Fig2	Xinje XD/XE series
			RS485	Fig 3	

### 2.2.2 Parameters

#### 1. HMI settings

Parameter	Recommend settings	Choices of settings	Note
PLC type	XD/XL/XE/XG series	Xinje XD/XL/XG Series / Modbus RTU(HMI is Master) / Modbus ASCII(HMI is Master)	None
Port	RS232	RS232 or RS485	
Data bit	8		
Stop bit	1		
Parity	Even parity		
Baud rate	19200	4800/9600/19200/38400/57600/115200	
Station No.	1	0~255	

The default communication parameters for the Xinje XD/XE series protocol are:

#### 2. PLC settings:

(1) PLC protocol type selecting: XINJE XD/XL/XE/XG series or Modbus RTU(HMI is master) :

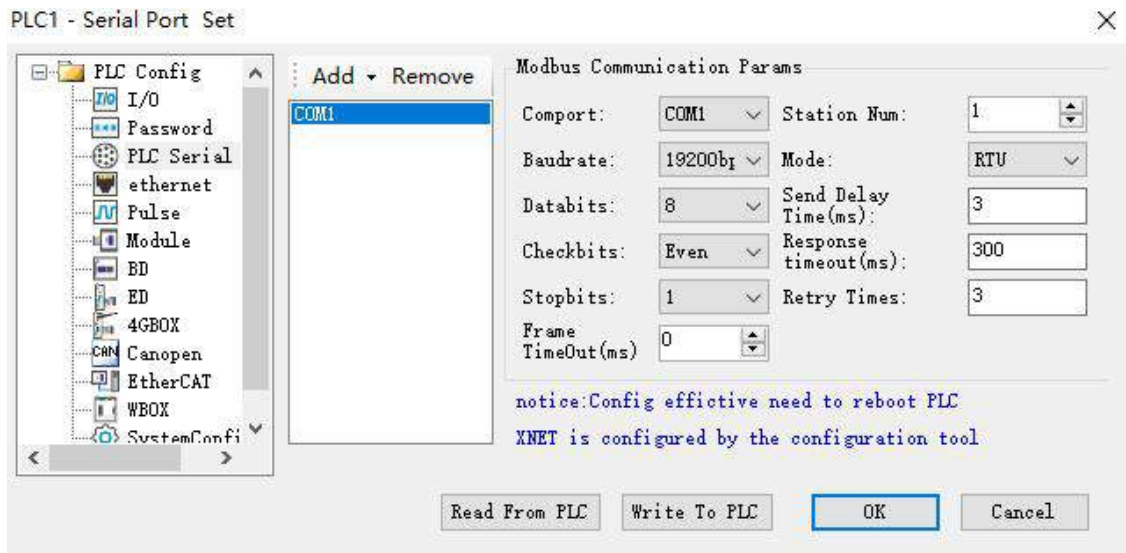

(2) PLC protocol type selecting: Modbus ASCII(HMI is master) :

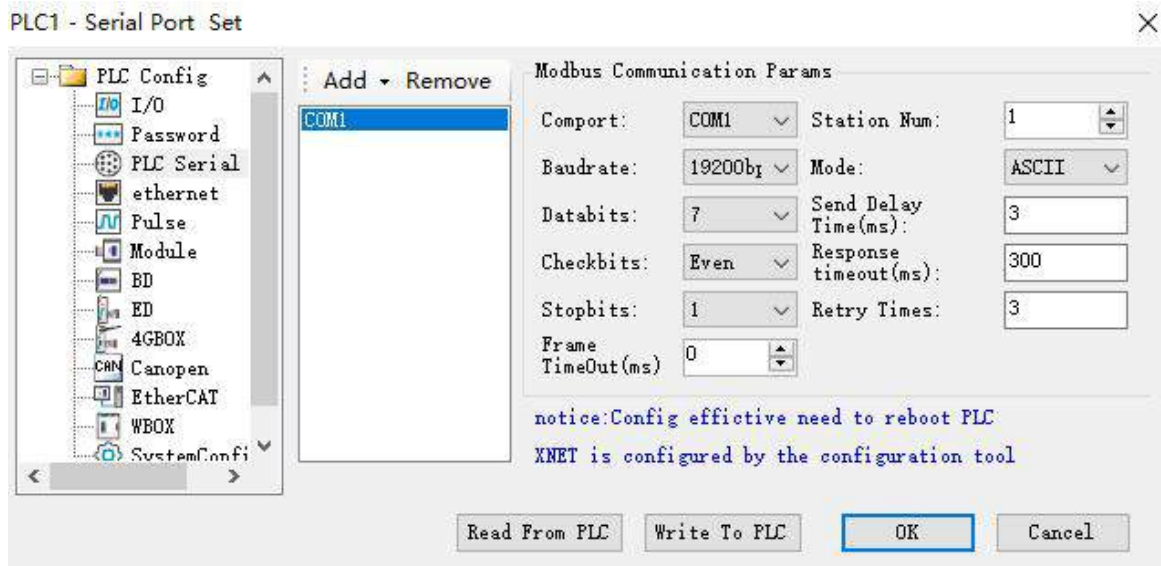

### 2.2.3 Cable making

1. Connect to XD/XE series PLC CPU (RS232 port)

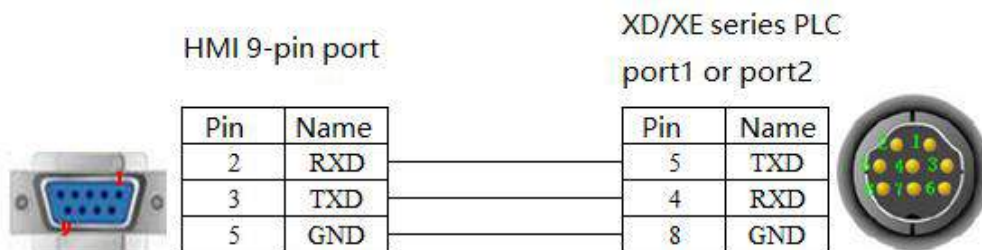

( Fig 1 )

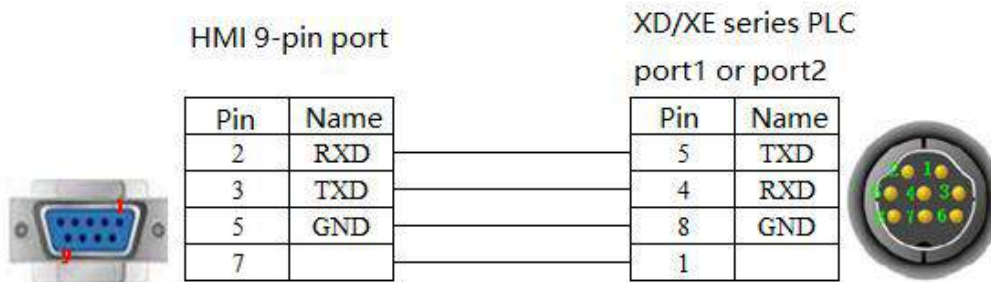

( Fig 2 )

**Note:** XP3-16 must use the communication line shown in Figure 2 (XVP line) when downloading program.

2. Connect to XD/XE series PLC CPU (RS485 port)

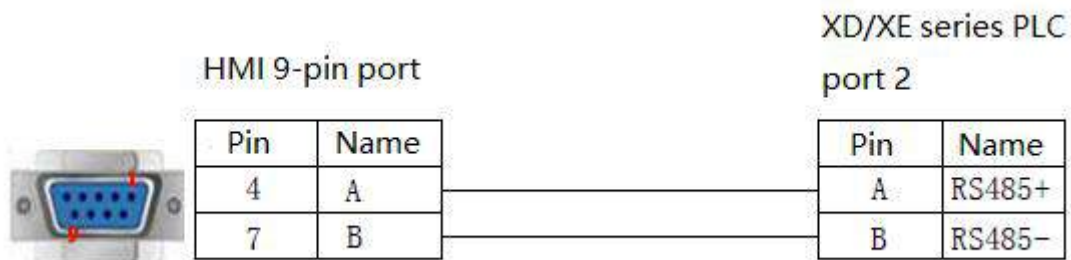

( Fig 3 )

#### 2.2.4 Device address

PLC address type	Range	Object type	Explanation
X	0~30077	Bit	External input coil relay
X1 xxxx	0~1777	Bit	Extended module External input coil relay
X2 xxxx	0~177	Bit	Extended BD External input coil relay
X3XXXX	0~77	Bit	Left expansion module External input coil
Y	0~30077	Bit	External output coil relay
Y1 xxxx	0~1777	Bit	Extended module External output coil relay
Y2 xxxx	0~277	Bit	Extended BD External output coil relay
Y3XXXX	0~77	Bit	Left expansion module External output coil
M	0~699999	Bit	Internal relay
S	0~79999	Bit	Flow
SM	0~49999	Bit	Internal relay, special using
T	0~49999	Bit	Timer
C	0~49999	Bit	Counter
ET	0~127	Bit	Timer, precise timer
SE	0~31	Bit	Sequence block wait instruction special coil
HM	0~47999	Bit	Internal relay, power-off retentive
HS	0~3999	Bit	Flow, power-off retentive
HT	0~7999	Bit	Auxiliary relay, power-off retentive
HC	0~7999	Bit	Counter, power-off retentive
HSC	0~39	Bit	Counter, high speed counter
D	0~69999	Word/DWord	Data register
ID	0~30099	Word/DWord	Analog External input coil
ID1xxxx	0~1599	Word/DWord	Extended module analog External input coil
ID2xxxx	0~199	Word/DWord	Extended BD analog External input coil

PLC address type	Range	Object type	Explanation
ID3XXXX	0~99	Word/DWord	Extended ED board analog External input coil
QD	0~30099	Word/DWord	Analog External output coil
QD1xxxx	0~1599	Word/DWord	Extended module analog External output coil
QD2xxxx	0~199	Word/DWord	Extended BD analog External output coil
QD3XXXX	0~99	Word/DWord	Extended ED board analog External output coil
SD	0~49999	Word/DWord	Data register, special using
TD	0~49999	Word/DWord	Timer value
CD	0~49999	Word/DWord	Counter value
ETD	0~39	Word/DWord	Timer value, precise timer
HD	0~24999	Word/DWord	Data register
HSD	0~1023	Word/DWord	Data register, power-off retentive
HTD	0~7999	Word/DWord	Timer value, power-off retentive
HCD	0~7999	Word/DWord	Counter value, power-off retentive
HSCD	0~39	Word/DWord	Counter value, high speed counter
FD	0~8192	Word/DWord	FlashROM register
SFD	0~9999	Word/DWord	FlashROM register, special using
FS	0~299	Word/DWord	Special security register
DM	0~700000	Word	For data register
DX	0~30077	Word	For data register
DX1xxxx	0~1777	Word	For data register, extended module
DX2xxxx	0~177	Word	For data register, extended BD
DX3XXXX	0~77	Word	For data register, extended ED
DY	0~30077	Word	For data register
DY1xxxx	0~1777	Word	For data register, extended module
DY2xxxx	0~177	Word	For data register, extended BD
DY3XXXX	0~77	Word	For data register, extended ED
DS	0~79999	Word	For data register
DSM	0~49999	Word	For data register, special function using
DT	0~49999	Word	For data register
DC	0~49999	Word	For data register
DET	0~39	Word	For data register, precise timer
DSE	0~999	Word	For data register, WAIT instruction
DHM	0~47999	Word	For data register, power-off retentive
DHS	0~3999	Word	For data register, power-off retentive
DHT	0~7999	Word	For data register, power-off retentive
DHC	0~7999	Word	For data register, power-off retentive
DHSC	0~39	Word	For data register, high speed counter

## 2.3 XINJE XD/XL/XG (Ethernet) series PLC( Modbus TCP )

### 2.3.1 Device type

Series	CPU	Connected module	Port	Cable making	PLC model in Touchwin software
XD XL XG	XD3E XD5E	CPU direct connection	RJ45	Fig 1 or Fig 2	Xinje XD / XL / XG series (Modbus TCP)
	XL5E XGE	Communication module T-BOX			

### 2.3.2 Parameters

Taking XDE series PLC as an example, this paper explains the communication setting of Xinje XD/XL/XG series protocol.

#### 1. PLC settings

There are two methods to configure PLC Ethernet parameters: direct configuration through PLC software and configuration using config tool. The two configurations are interrelated. Just use one of them..

Method 1: connect the PLC to the computer, open the PLC programming software, open the PLC configuration in the engineering column on the left side of the software, double-click the “Ethernet port” below, manually set the Ethernet parameters of PLC in the pop-up configuration window, and click “write to PLC” after setting:

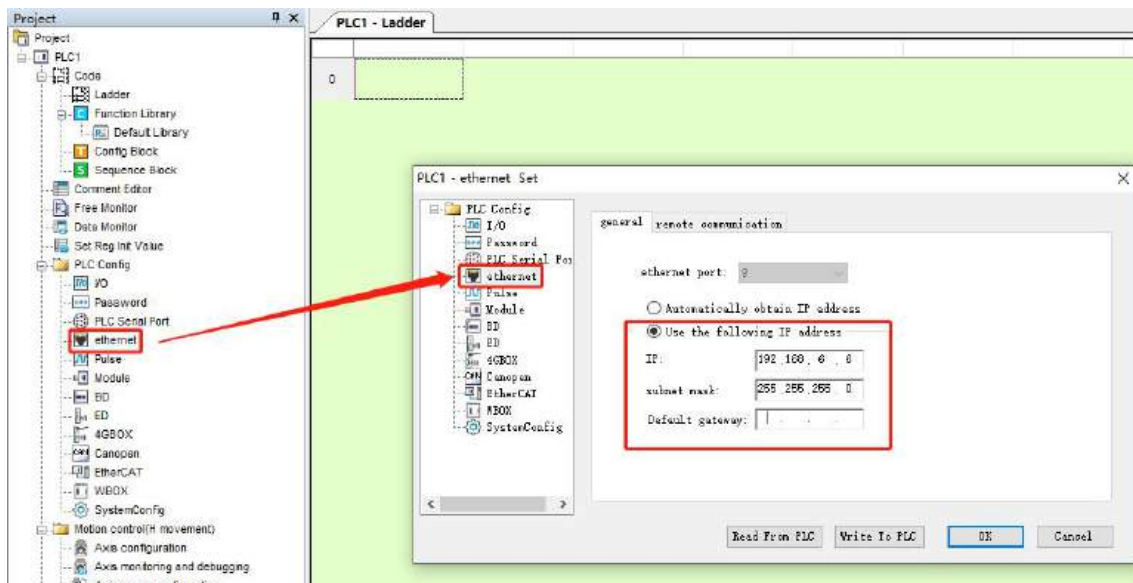

**Note: After the parameter is written, the PLC needs to be restarted to take effect.**

Method 2: Connect the PLC to the computer, first connect the PLC with the config tool, open the config tool, then click PLC - find device- XNET:

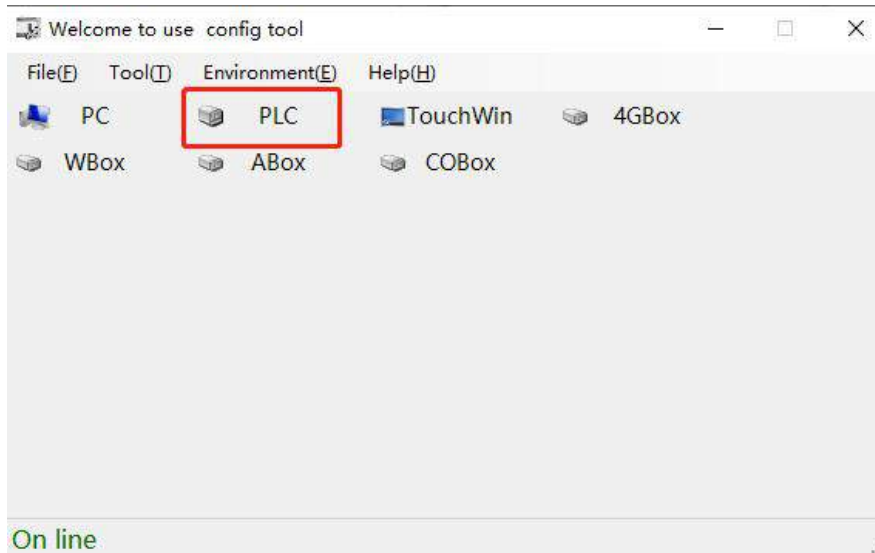

Set the port number of the computer in the pop-up window (you can view it in computer device manager - port)

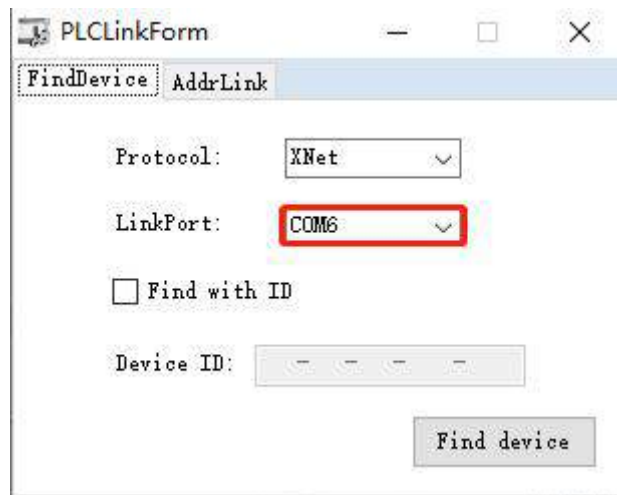

After successfully locating the PLC, it will automatically return to the interface when config was first opened. If an error message pops up, it indicates that the search for the PLC has failed. At this time, you can check whether the PLC and computer are connected properly and repeat the above search operation until there is no error message.

After the PLC is successfully connected, click Ethernet:

Set the Ethernet parameters (IP address, mask and gate) of PLC in the pop-up window. The Ethernet port here defaults 9 and should not be modified. Click “write” after setting.

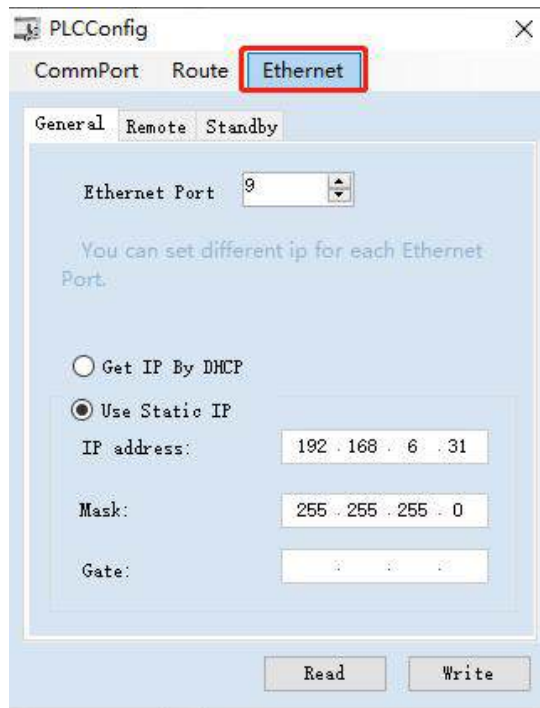

**Note:** After the parameter is written, the PLC needs to be restarted to take effect.

2. HMI settings:

- (1) After selecting the human-machine interface model as - E, click to enter the next step, select "Net1" in the device list, and in "Set Local IP", IP address: the IP address of the human-machine interface, as long as it doesn't conflict with other IPs in the network. In this example, the IP of the PLC is 192.168.6.6, and the device itself can be set to 192.168.6.10.

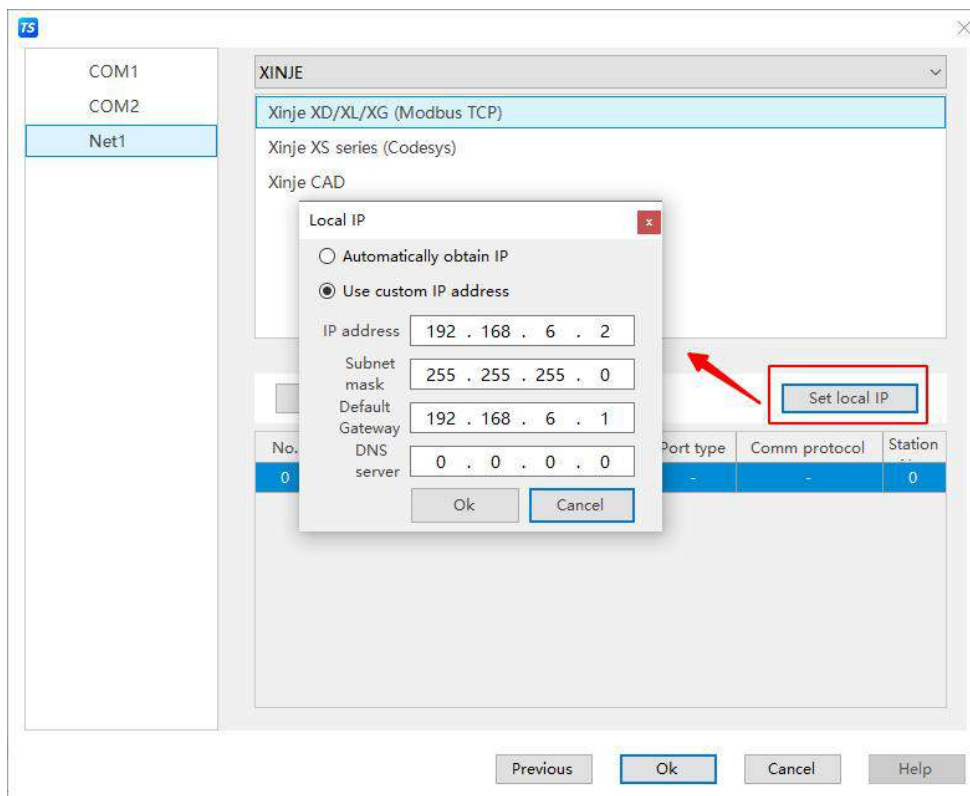

- (2) Click the drop-down button, select "Xinje" from the brand list, click the mouse to select "Xinje XD/XL/XG series (Modbus TCP)", then select "New Device", and set communication parameters such as device name and IP in the pop-up communication settings window. This IP address is the IP address of Xinje PLC, with a

default port number of 502 and cannot be modified. After setting up, click "Confirm".

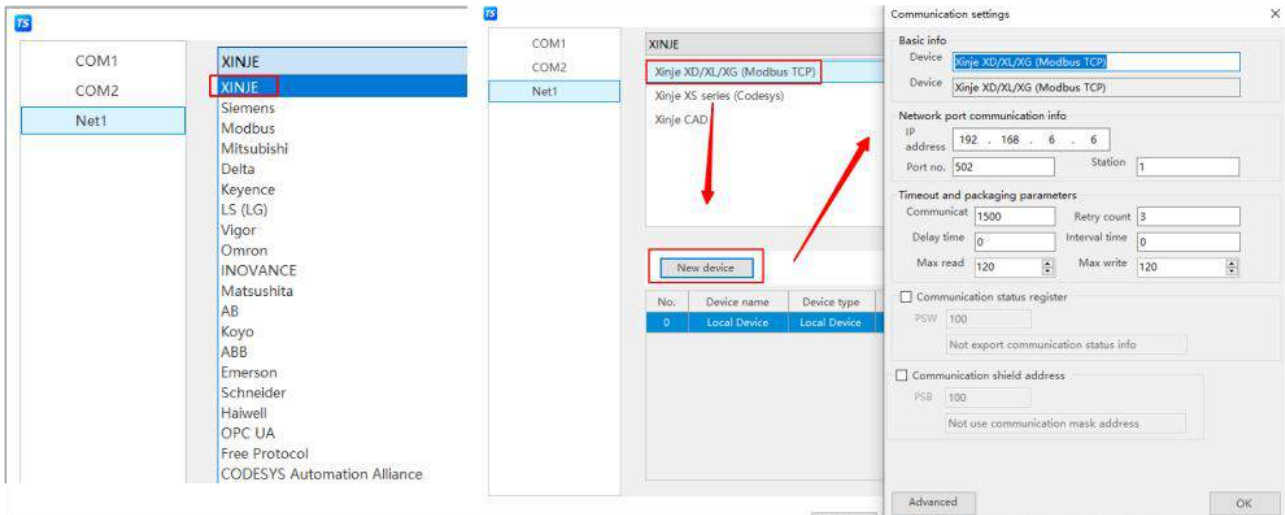

- (3) Check the "Communication Status Register" and PSW is set to 100 by default. PSW100~PSW103 represent the number of communication successes, communication failures, communication timeouts, and communication errors, respectively. Customers can set this communication status register themselves.

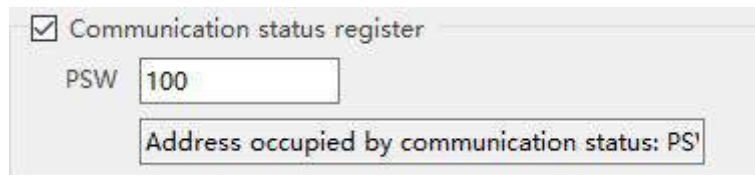

- (4) After setting up, click "Confirm" to end the setup and enter the screen editing interface. Place a data External input coil component on the screen, select the corresponding device "Xinje XD Series" from the device drop-down menu :

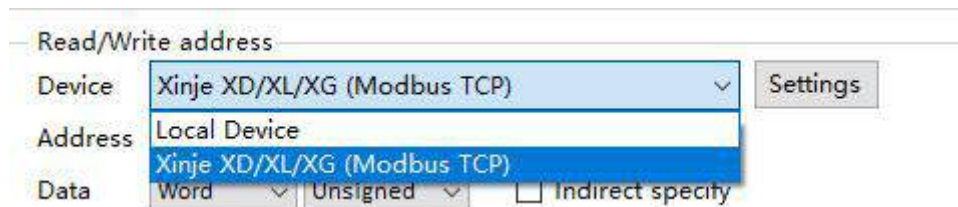

### 2.3.3 Cable making

RJ45 Straight Through Cable (connected to HUB) or RJ45 Crossover Cable :

Pin no.	Color		Pin no.	Color
1	White orange	—————	1	White orange
2	orange	—————	2	orange
3	White green	—————	3	White green
4	blue	—————	4	blue
5	White blue	—————	5	White blue
6	Green	—————	6	Green
7	White brown	—————	7	White brown
8	Brown	—————	8	Brown

( Fig 1 )

Pin no.	Color		Pin no.	Color
1	White orange		1	White green
2	orange		2	Green
3	White green		3	White orange
4	blue		4	blue
5	White blue		5	White blue
6	Green		6	orange
7	White brown		7	White brown
8	Brown		8	Brown

( Fig 2 )

#### 2.3.4 Device address

PLC address	Range	Object type	Notes
X	0~77777777	Bit	External input coil relay
X1 xxxx	0~77777777	Bit	Extended module External input coil relay
X2 xxxx	0~77777777	Bit	Extended BD External input coil relay
X3XXXX	0~77	Bit	Extended ED External input coil relay
Y	0~77777777	Bit	External output coil relay
Y1 xxxx	0~77777777	Bit	Extended module External output coil relay
Y2 xxxx	0~77777777	Bit	Extended BD External output coil relay
Y3XXXX	0~77	Bit	Extended ED External output coil relay
M	0~99999999	Bit	Internal relay
S	0~99999999	Bit	Flow
SM	0~99999999	Bit	Internal relay, special using
T	0~99999999	Bit	Timer
C	0~99999999	Bit	Counter
ET	0~99999999	Bit	Timer, precise timer
SE	0~99999999	Bit	Sequence block wait instruction special coil
HM	0~99999999	Bit	Internal relay, power-off retentive
HS	0~99999999	Bit	Flow, power-off retentive
HT	0~99999999	Bit	Auxiliary relay, power-off retentive
HC	0~99999999	Bit	Counter, power-off retentive
HSC	0~99999999	Bit	Counter, high speed counter
D	0~99999999	Word/DWord	Data register
ID	0~99999999	Word/DWord	Analog External input coil
ID1xxxx	0~99999999	Word/DWord	Extended module analog External input coil
ID2xxxx	0~99999999	Word/DWord	Extended BD analog External input coil
ID3XXXX	0~99	Word/DWord	Extended ED analog External input coil
QD	0~99999999	Word/DWord	Analog External output coil
QD1xxxx	0~99999999	Word/DWord	Extended module analog External output coil
QD2xxxx	0~99999999	Word/DWord	Extended BD analog External output coil
QD3XXXX	0~99	Word/DWord	Extended ED analog External output coil
SD	0~99999999	Word/DWord	Data register, special using

PLC address	Range	Object type	Notes
TD	0~99999999	Word/DWord	Timer value
CD	0~99999999	Word/DWord	Counter value
ETD	0~99999999	Word/DWord	Timer value, precise timer
HD	0~99999999	Word/DWord	Data register
HSD	0~99999999	Word/DWord	Data register, power-off retentive
HTD	0~99999999	Word/DWord	Timer value, power-off retentive
HCD	0~99999999	Word/DWord	Counter value, power-off retentive
HSCD	0~99999999	Word/DWord	Counter value, high speed counter
FD	0~99999999	Word/DWord	FlashROM register
SFD	0~99999999	Word/DWord	FlashROM register, special using
FS	0~99999999	Word/DWord	Special security register
DM	0~99999999	Word	For data register
DX	0~77777777	Word	For data register
DX1xxxx	0~77777777	Word	For data register, extended module
DX2xxxx	0~77777777	Word	For data register, extended BD
DX3XXXX	0~77777777	Word	For data register, extended ED
DY	0~77777777	Word	For data register
DY1xxxx	0~77777777	Word	For data register, extended module
DY2xxxx	0~77777777	Word	For data register, extended BD
DY3XXXX	0~77777777	Word	For data register, extended ED
DS	0~99999999	Word	For data register
DSM	0~99999999	Word	For data register, special function using
DT	0~99999999	Word	For data register
DC	0~99999999	Word	For data register
DET	0~99999999	Word	For data register, precise timer
DSE	0~99999999	Word	For data register, WAIT instruction
DHM	0~99999999	Word	For data register, power-off retentive
DHS	0~99999999	Word	For data register, power-off retentive
DHT	0~99999999	Word	For data register, power-off retentive
DHC	0~99999999	Word	For data register, power-off retentive
DHSC	0~99999999	Word	For data register, high speed counter

## 2.4 Xinje XS series (CodeSys) - Label communication

### 2.4.1 Device type

Series	CPU	Connected module	Port	Cable making	PLC model in Touchwin software
XS	XS3/XSDH XSLH/XSA	CPU direct connection	RJ45	Fig1 or Fig2	XINJE XS series ( Codesys )

### 2.4.2 Parameters

Taking XSDH series PLC as an example, use the Xinje XS Studio software to explain the communication settings of the Xinje XS series (Codesys) protocol equipment.

#### 1. PLC settings:

- (1) Open the XS Studio software to create a new project, select the standard project, and select the XSDH-60A32 model. After completing the selection, click OK and pay attention to the file storage location. The XML file will be generated in this folder in the future.

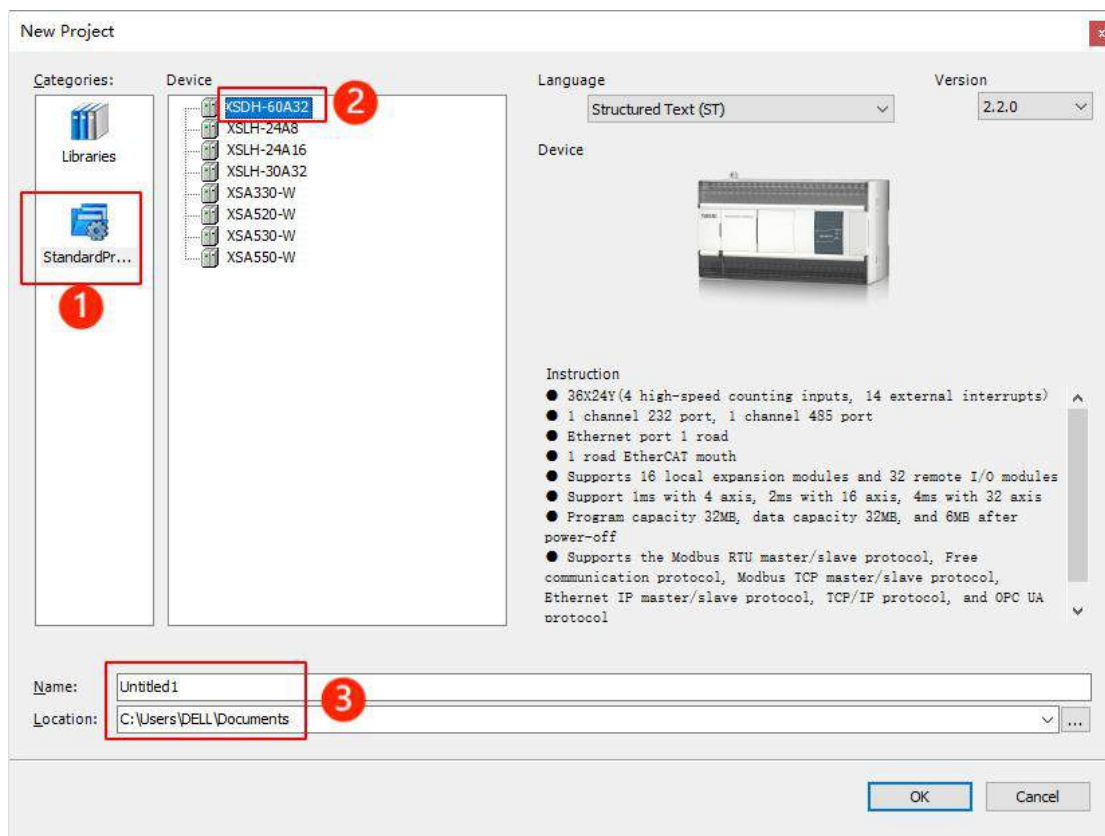

- (2) Add variables to PLC, taking the example of adding variables to a new POU: right-click on Application - Add Object - POU.

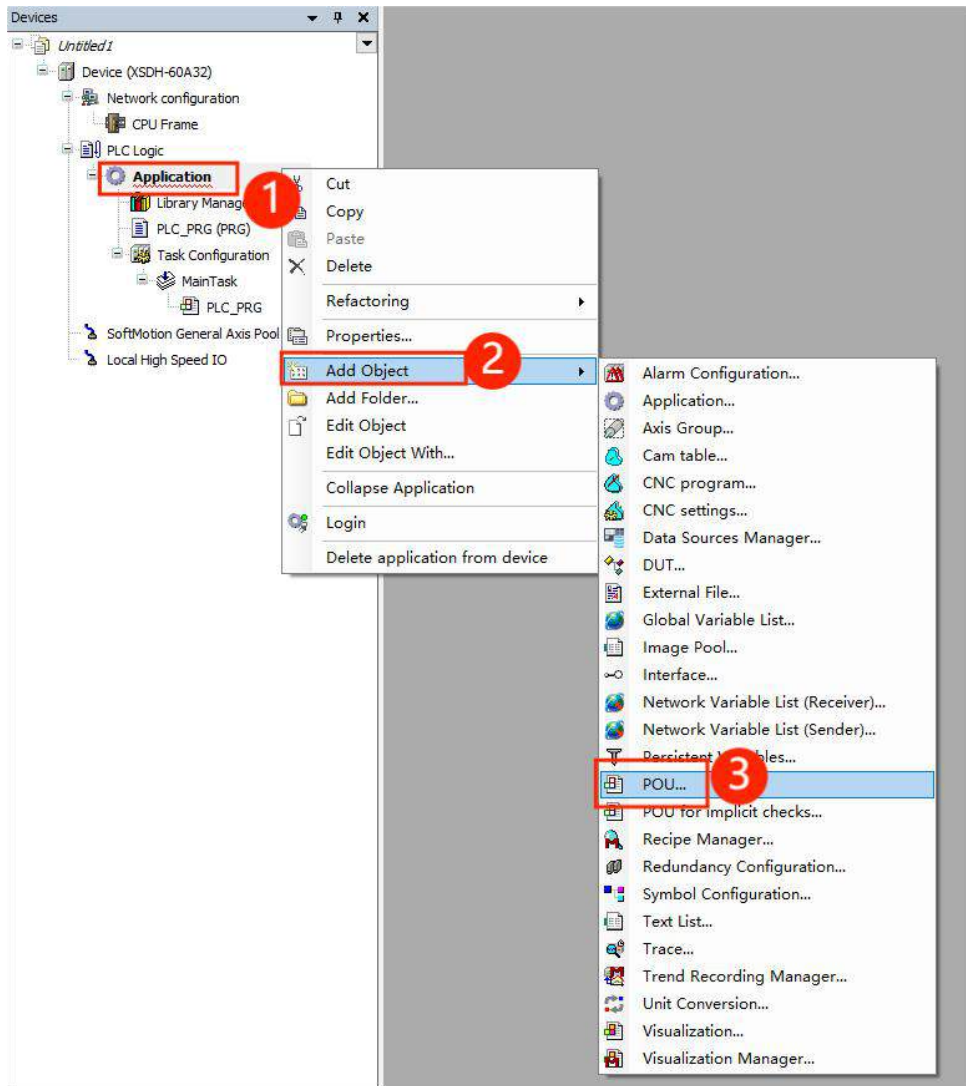

- (3) Taking the example of adding variables to POU to create BOOL type variables aa and INT type variables bb, the current supported data types are shown in 2.4.4. After creation, click compile.

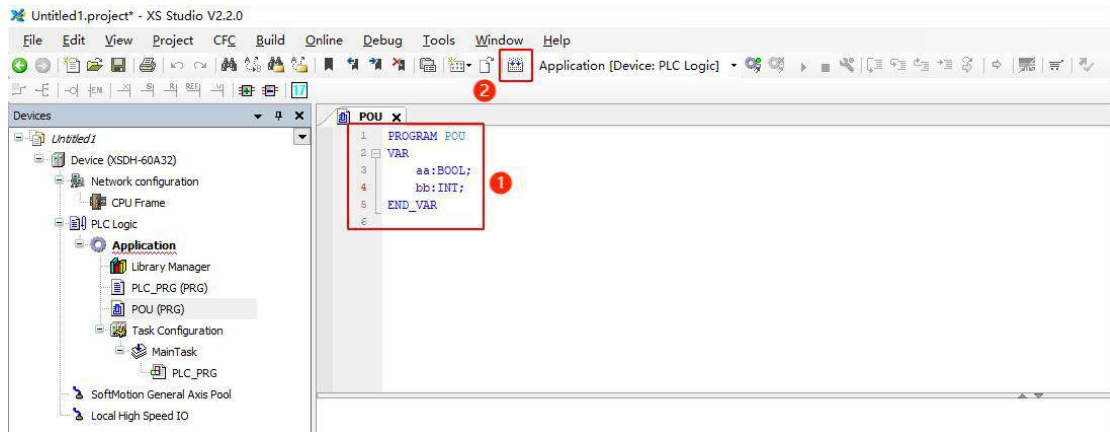

- (4) Right click on Application - Add Object - Symbol Configuration.

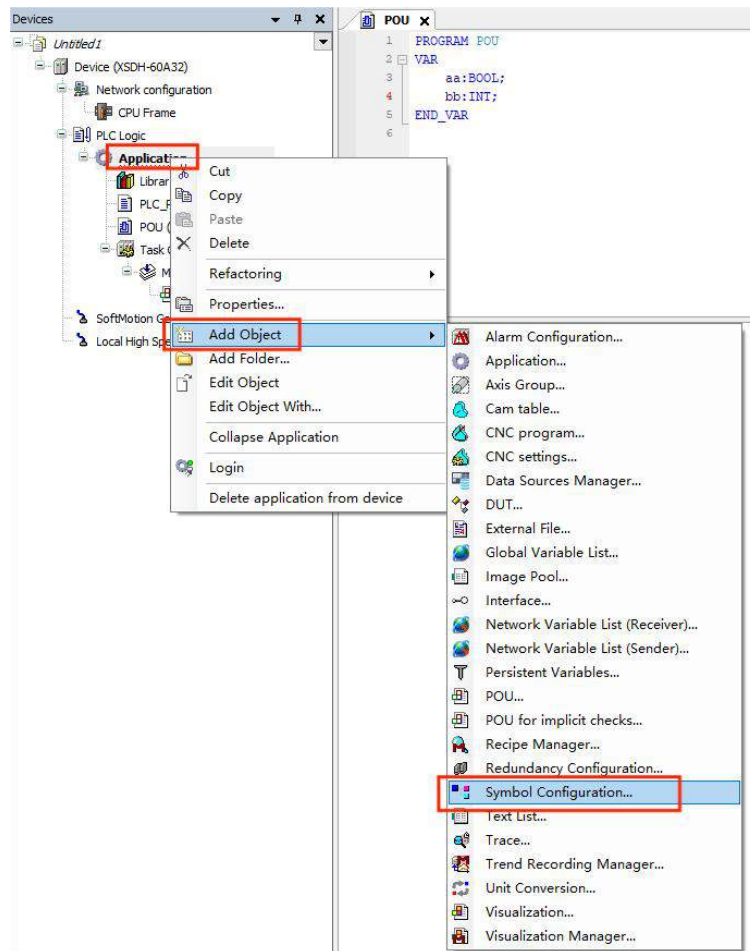

(5) Click to open, check all options, click compile.

Add Symbol Configuration ✕

 Create a remote access symbol configuration.

Name

Symbol Configuration

Include comments in XML

Support OPC UA features

Add library placeholder in Device Application  
(recommended, but may trigger download)

Client Side Data Layout

Compatibility Layout

Optimized Layout

1 Add Cancel

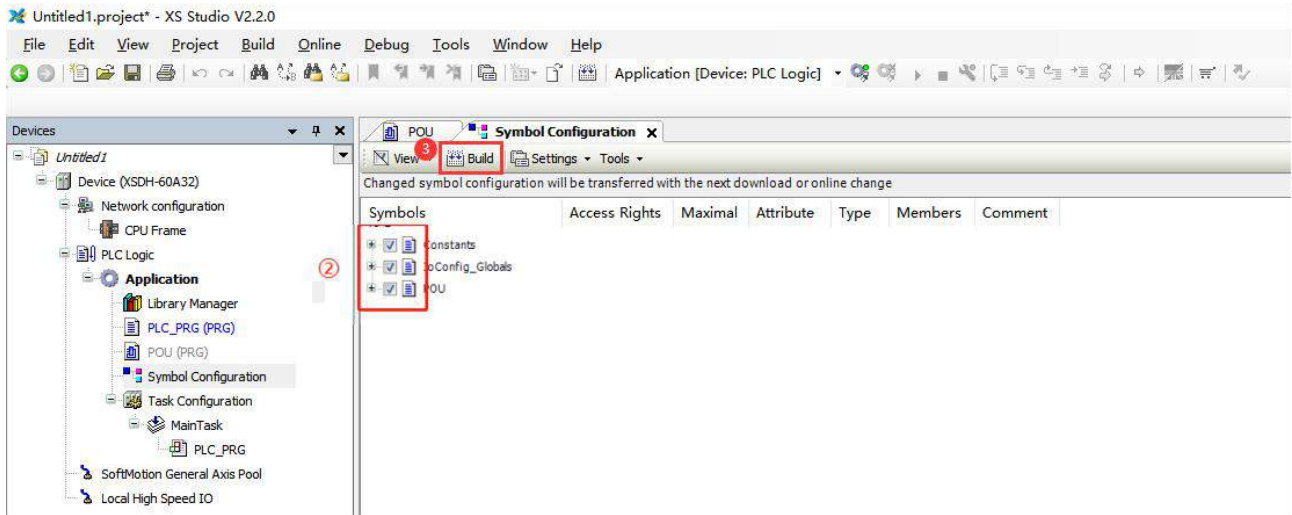

(6) Log in to the PLC and download the program. At this time, the corresponding XML file will be automatically generated in the corresponding directory of program creation.

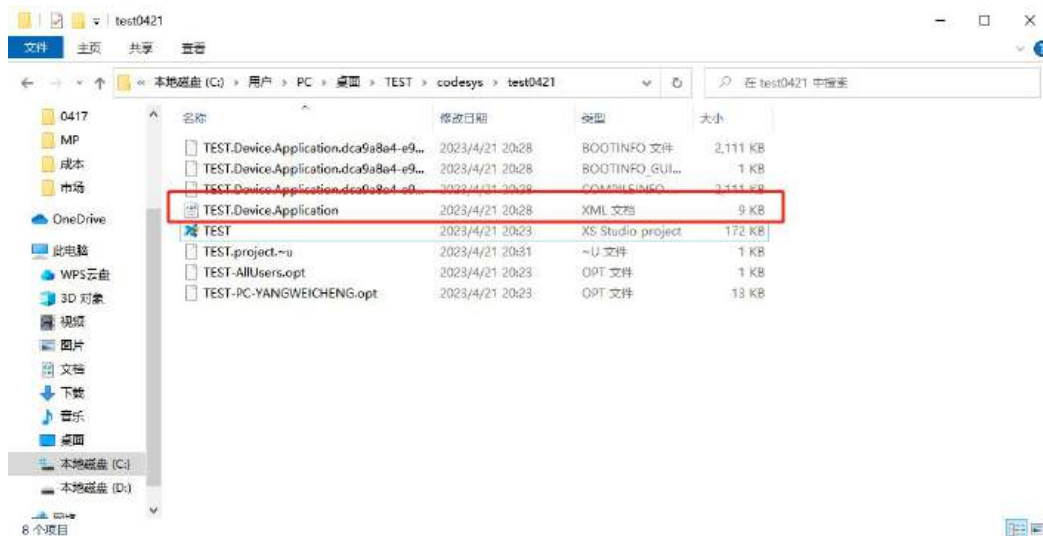
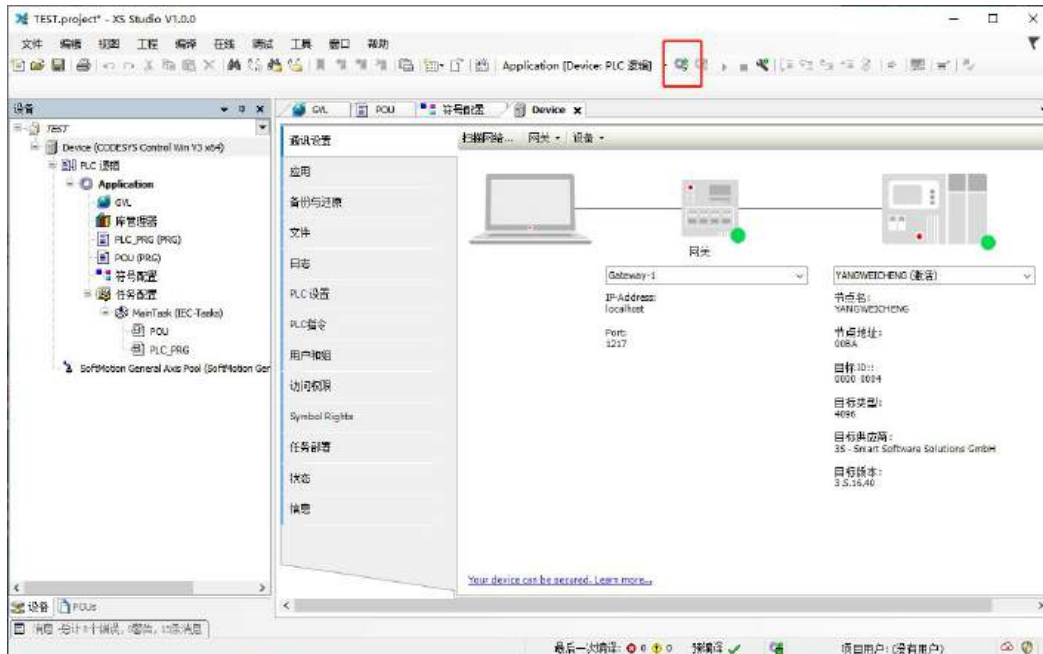

2. HMI settings:

- (1) After selecting the human-machine interface model as - E, click to proceed to the next step and select "Net1" in the device list, in "Set Local IP", IP address: the IP address of the human-machine interface, as long as it doesn't conflict with other IPs in the network, in this example, the IP of the PLC is 192.168.6.6, and the device itself can be set to 192.168.6.2.

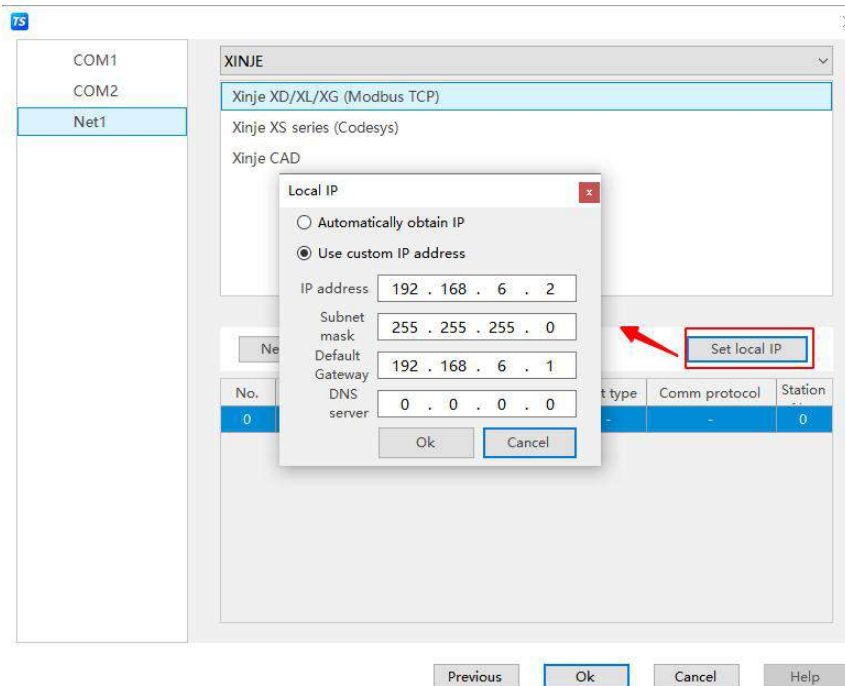

- (2) Click the drop-down button, select "XINJE" from the brand list, and click the mouse to select "XINJE XS Series (CodeSys)", then select "New Device" and set communication parameters such as device name and IP in the pop-up communication settings window, this IP address is the IP address of XINJE PLC. After setting it up, click "Confirm":

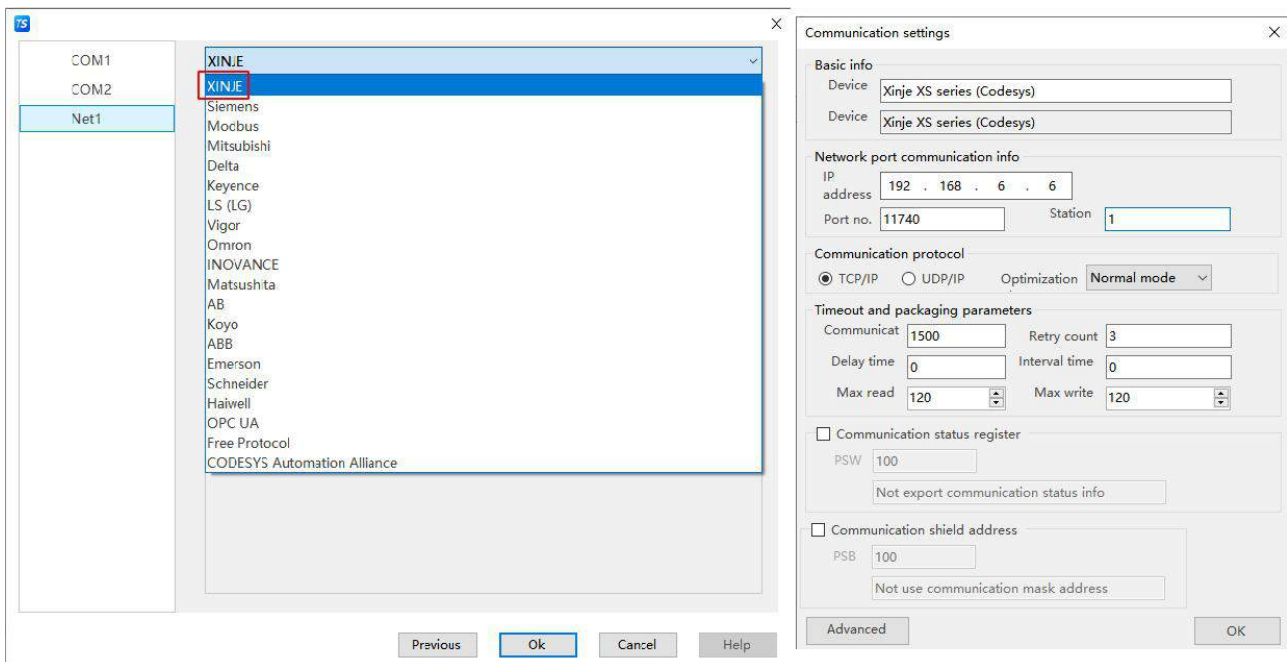

Project	Description
Communication Protocol	TCP/IP: Based on TCP communication. UDP/IP: Based on UDP communication.

Project	Description
	By default, TCP mode is used for higher reliability. When high speed is required, it can be switched to UDP mode.
Optimization schemes	<p>Normal mode: Single channel mode, with read priority higher than write.</p> <p>Write optimization: Single channel mode, with write priority higher than read.</p> <p>Dual channel mode: occupying two sets of channels, with independent priority for reading and writing.</p> <p>The default is normal mode, which can be set when there are special requirements for communication speed.</p> <p>When one machine has multiple screens, please pay attention to cooperating with PLC to allocate channels. You can specifically check the channel configuration on the PLC end (by entering channel info in the PLC shell).</p>

- (3) Check "Communication Status Register", PSW is set to 100 by default, PSW100~PSW103 respectively represent the number of successful communication attempts, communication failures, communication timeouts, and communication errors, this communication status register can be set by customers themselves.



- (4) Click on the import label, select the folder where the label was created, and select the corresponding label, pop up a window for successfully importing xx tags, click to close:

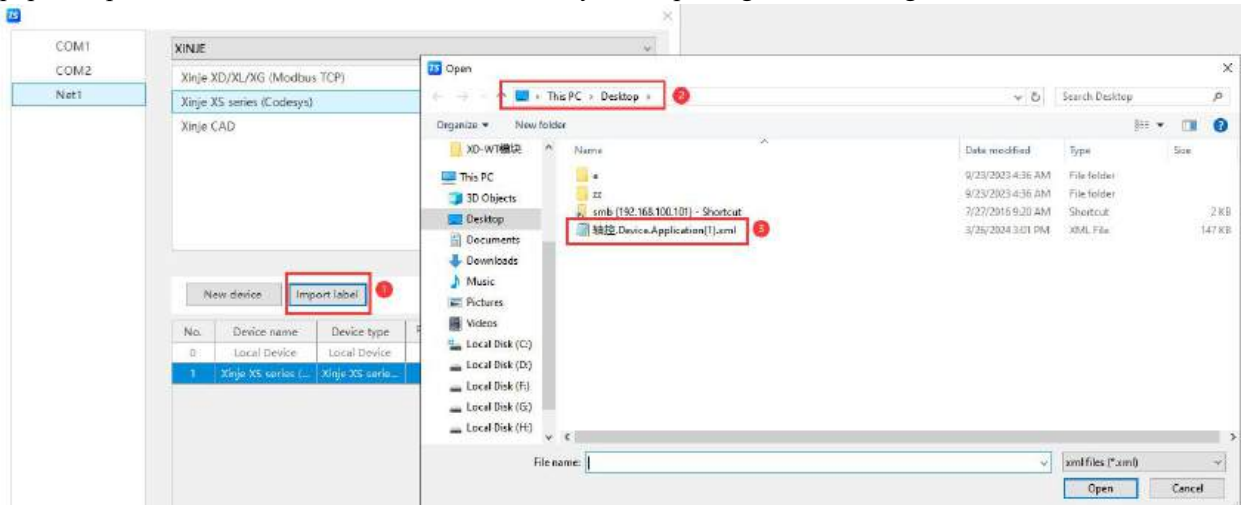

- (5) After clicking OK to complete the settings, click "Confirm" to end the settings and enter the screen editing interface. Place a numerical External input coil component on the screen, select the corresponding device "XINJE XS series (CodeSys)" from the device drop-down bar.

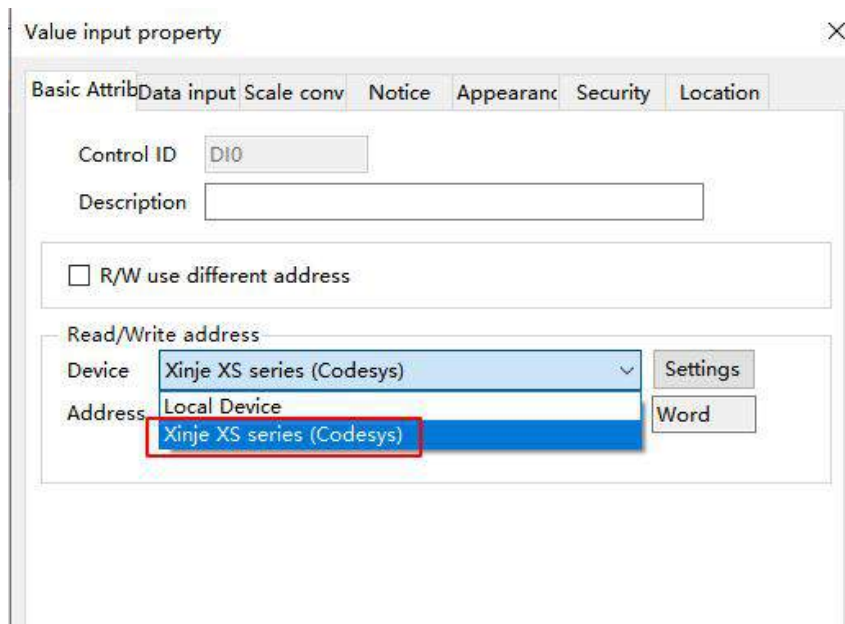

- (6) Click on the address, a pop-up window will pop up, select the corresponding label variable, and support label search function at position 4 in the figure.

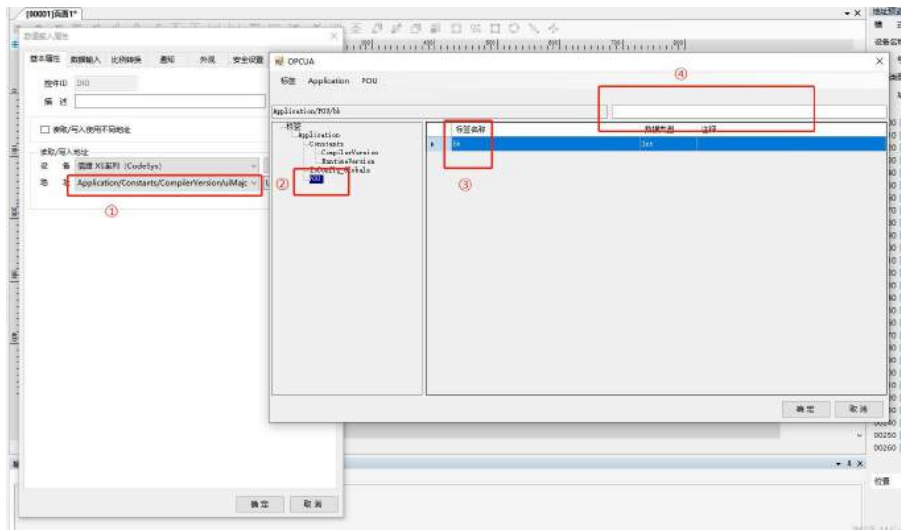

- (7) The search and deletion of tags can be done in the library address tag library device tag section.

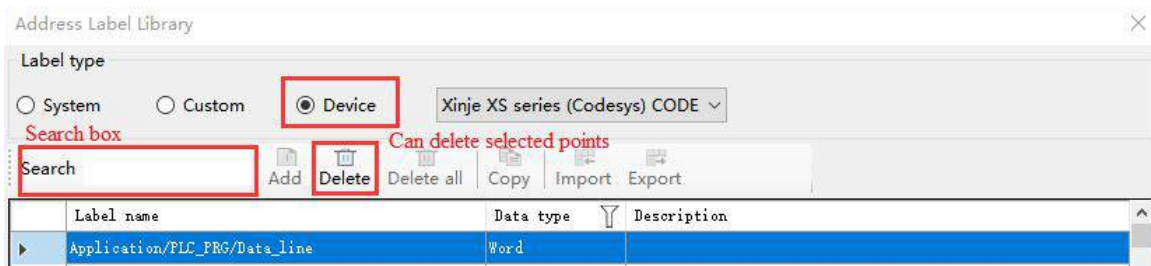
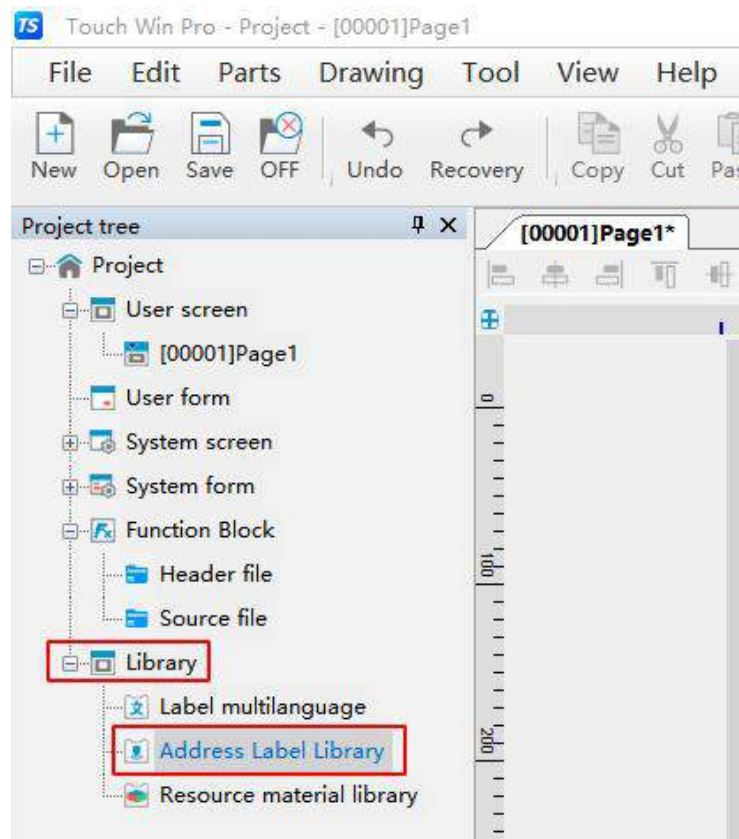

### 2.4.3 Cable making

RJ45 Straight Through Cable (connected to HUB) or RJ45 Crossover Cable :

Pin no.	Color		Pin no.	Color
1	White orange	—————	1	White orange
2	orange	—————	2	orange
3	White green	—————	3	White green
4	blue	—————	4	blue
5	White blue	—————	5	White blue
6	Green	—————	6	Green
7	White brown	—————	7	White brown
8	Brown	—————	8	Brown

( Fig 1 )

Pin no.	Color		Pin no.	Color
1	White orange		1	White green
2	orange		2	Green
3	White green		3	White orange
4	blue		4	blue
5	White blue		5	White blue
6	Green		6	orange
7	White brown		7	White brown
8	Brown		8	Brown

( Fig 2 )

## 2.4.4 Support data types

### Standard data type

Data categories	Data type	Keywords	Number of digits	Explain
BOOL	BOOL	BOOL	1	
INT	BYTE	BYTE	8	
	WORD	WORD	16	
	Double word	DWORD	32	
	Long word	LWORD	64	
	Short	SINT	8	
	unsigned short	USINT	8	
	INT	INT	16	
	unsigned int	UINT	16	
	Double int	DINT	32	
	Unsigned double int	UDINT	32	
	Long int type	LINT	64	
Real	Real	REAL	32	
	Long real	LREAL	64	
STRING	STRING	STRING	8*N	ASCII decoding

Note: Added support for word extraction and framing.

### Standard extended data type

Data categories	Data type	Keywords	Number of digits	Explain
STRING	Wide byte string	WSTRING	16*(N+1)	Unicode decoding

### Custom data type

Data type	Explain
Array	Supports up to 3D arrays
Structural morphology	Supports all basic data types

---

Structure array	Support
Consortium	Support

## 3 Siemens PLC Connection Instructions

This chapter mainly introduces the connection instructions between the touch screen and the external communication equipment of Siemens PLC.

**Note:**

- (1) **The Xinje TS series touch screen supports a maximum baud rate of 187.5K.**
- (2) **During communication, please don't plug or unplug cables with power, as it may cause damage to the device's serial port.**
- (3) **Upgrade of touch screen software version, there may be some changes in the communication protocol device address range. The device address range in the software shall prevail.**

### 3.1 Siemens S7-200 series PLC

#### 3.1.1 Device type

Series	CPU	Connected module	Port	Cable making	PLC model in Touchwin software
S7-200	CPU212 CPU221 CPU222 CPU224 CPU226	CPU connection direct	RS485	Fig1	Siemens S7-200
S7-200 smart	Smart series				

#### 3.1.2 Parameters

##### 1. HMI settings

Parameter	Recommend settings	Choices of settings	Note
PLC type	Siemens S7-200		None
Port	RS485		
Data bit	8		
Stop bit	1		
Parity	Even parity		
Baud rate	9600	9600/19200/187500	
Station No.	2		Must use recommend settings

Siemens S7-200 series protocol default communication parameters:

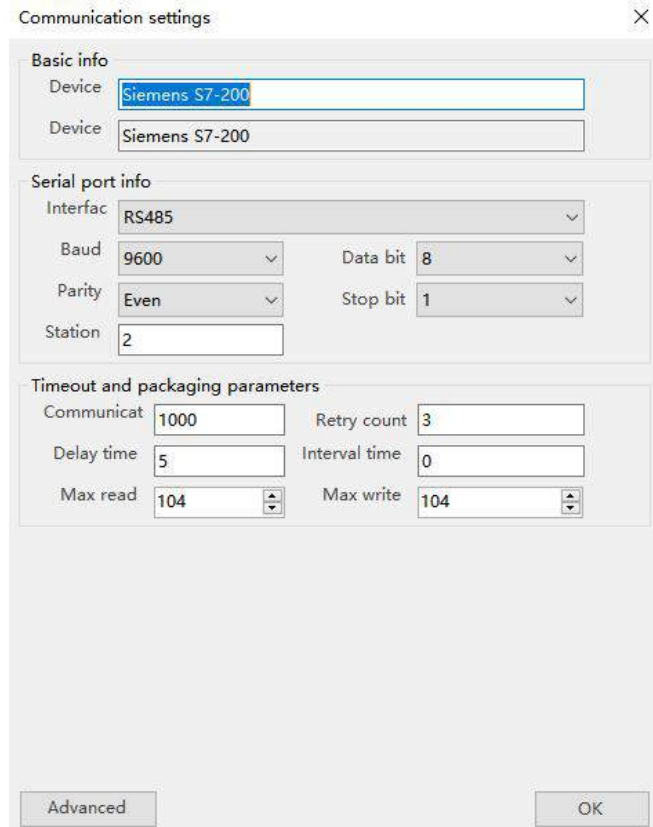

## 2. S7-200 software settings



### Notes:

- ◆ Siemens register structure: VB occupies 8 bits, VW occupies 16 bits, and VD occupies 32 bits.
- ◆ Its address space overlaps, and VW must start with an even number to be divisible by 2, for example: VW0, VW2, VW4,....., VD must be a multiple of 4, for example: VD0, VD4, VD8.
- ◆ Data block PSW single word → VW single word operation, due to the issue of distinguishing high and low bytes, it's recommended to use register copying function as it can cause data misalignment in the received data.
- ◆ Data block transfer PSW single word → VD Double Word, the units are inconsistent and it's not allowed to transmit in this way, suggest using register copying.

### 3.1.3 Cable making

HMI connects to S7-200 via RS485:

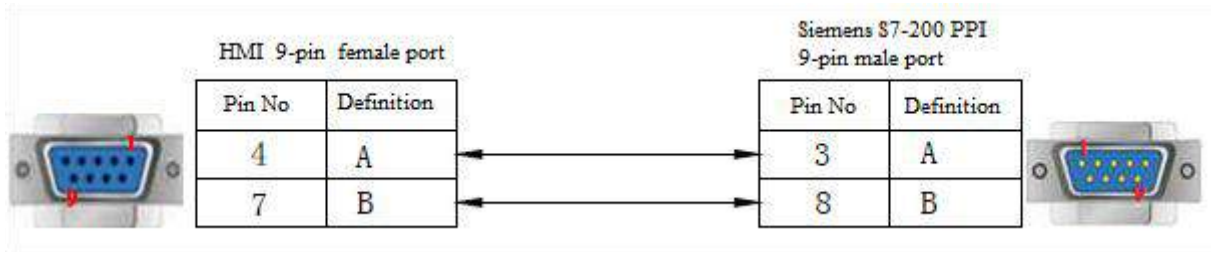

( Fig1 )

### 3.1.4 Device address

SIMATIC S7-200 series

PLC address type	Range	Object type	Notes
VB	0~9999	Byte	Variable Byte Data Register
VW	0~9999	Word	Variable Word Data Register
VD	0~9999	DWord	Variable Double Word Data Register
IB	0~15	Byte	External External input coil byte image register
IW	0~15	Word	External External input coil word image register
ID	0~15	DWord	External External input coil double word image register
QB	0~15	Byte	External External output coil byte image register
QW	0~15	Word	External External output coil word image register
QD	0~15	DWord	External External output coil double word image register
MB	0~31	Byte	Internal auxiliary byte register
MW	0~31	Word	Internal auxiliary word register
MD	0~31	DWord	Internal auxiliary double word register
SMB	0~299	Byte	Internal special auxiliary byte register
SMW	0~299	Word	Internal special auxiliary word register
SMD	0~299	DWord	Internal special auxiliary double word register
SB	0~31	Byte	Special auxiliary byte register
SW	0~31	Word	Special auxiliary word register
SD	0~31	DWord	Special auxiliary double word register
T	0~255	Word	Used as a register
C	0~255	Word	Used as a register
M	0.0~31.7	Bit	Bit register
V	0.0~9999.7	Bit	Variable register
I	0.0~15.7	Bit	External input coil
Q	0.0~15.7	Bit	External output coil
SM	0.0~299.7	Bit	Special sequence control relay
S	0.0~31.7	Bit	Sequence control relay
T	0~255	Bit	Timer
C	0~255	Bit	Counter

**Note:** Siemens VB/VW/VD selects the corresponding data type by changing the data type after selecting the V address.

## 3.2 Siemens S7-200 Smart Series Ethernet

### 3.2.1 Device type

Series	Port	Cable making	PLC model in Touchwin software
S7-200 smart	RJ45	Fig 1 or Fig 2	Simens S7-200 Smart series

### 3.2.2 Parameters

#### 1. PLC settings

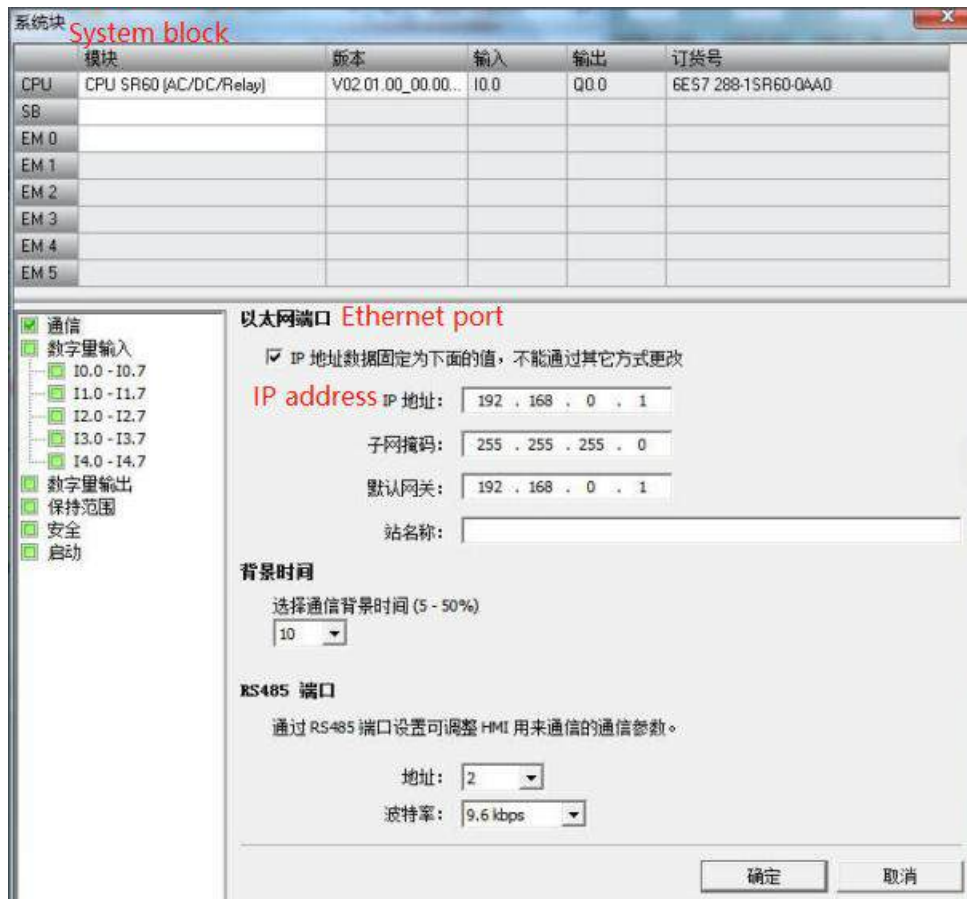

#### 2. HMI settings

- (1) After selecting the human-machine interface model as - E, click to enter the next step, select "Net1" in the device list, and set the IP address used for the human-machine interface in "Set Local IP", as long as it doesn't conflict with other IPs in the network.

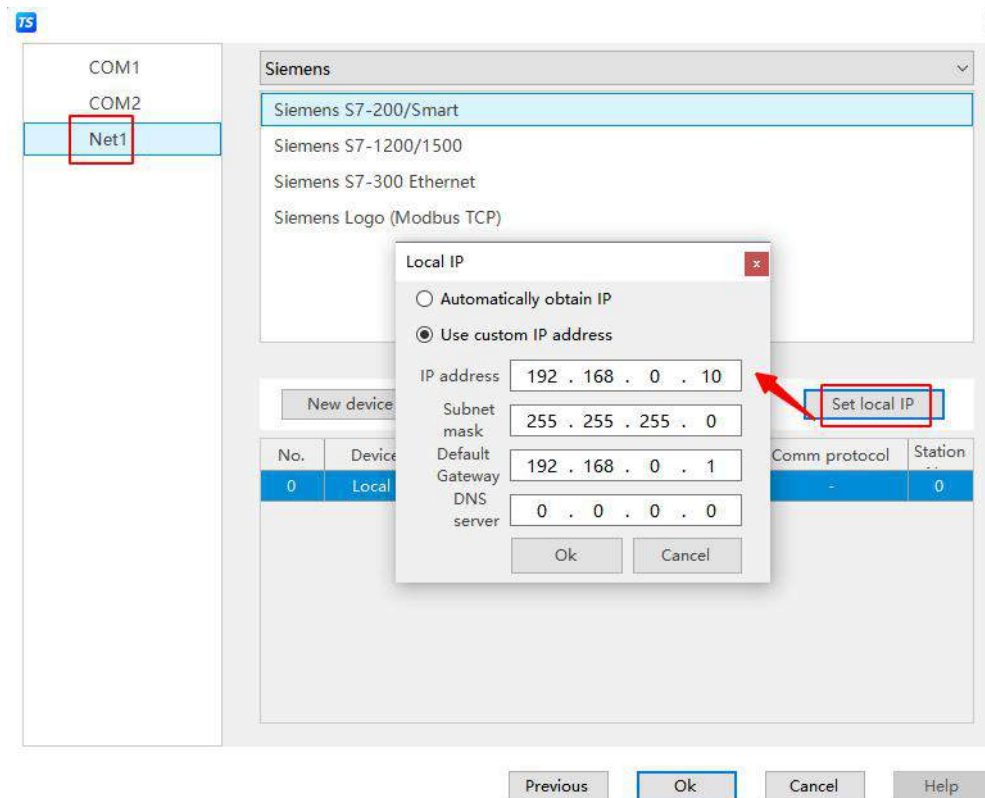

- (2) Click the drop-down button, select "Siemens" from the brand list, click the mouse to select "Siemens S7-200 Smart Series", then select "New Device", and set communication parameters such as device name and IP in the pop-up communication settings window. This IP address is the IP address of S7-200 smart. In this example, the IP address of "Siemens S7-200 smart" is "192.168.0.1", and the port number is fixed to 102 and cannot be modified. After setting up, click "Confirm":

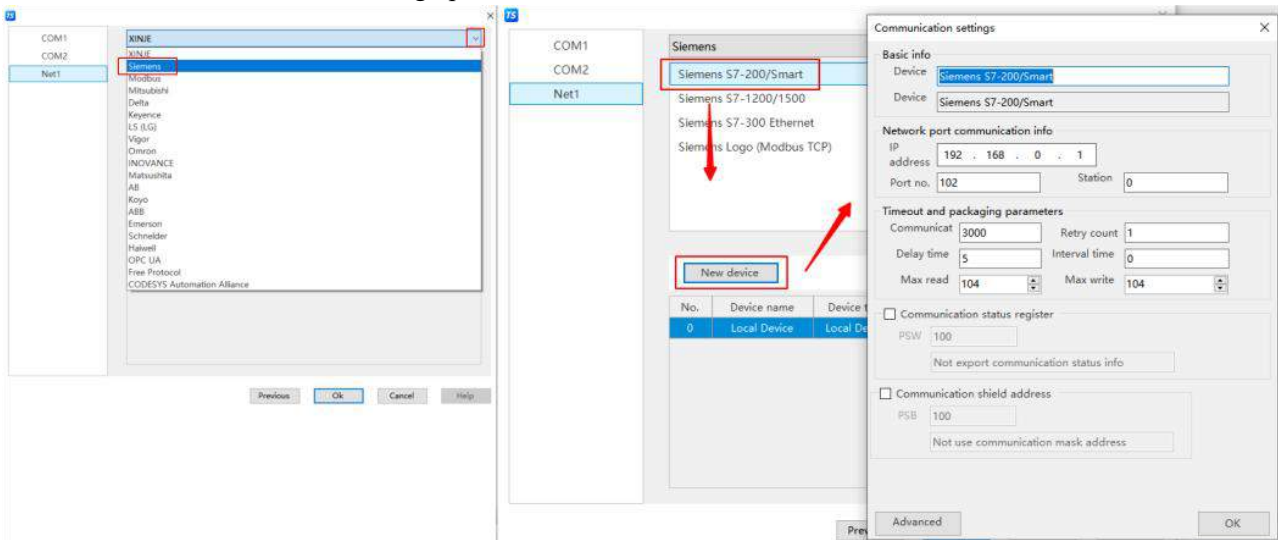

- (3) Check the "Communication Status Register" and PSW is set to 100 by default. PSW100~PSW103 represent the number of successful communication attempts, communication failures, communication timeouts, and communication errors, respectively. Customers can set this communication status register themselves.



- (4) After setting up, click "Confirm" to end the setup and enter the screen editing interface. Place a data External input coil component on the screen, select the corresponding device "Siemens S7-200 Smart Series" from the device drop-down bar:

Read/Write address

Device	Local Device	Settings
Address	Local Device	
Data	Word	Unsigned
	<input type="checkbox"/> Indirect specify	

There is no station number issue with Siemens S7-200 smart, as long as the IP address is correct, it's sufficient. So, a multi screen one machine, one screen multiple machines, and multi screen multiple machines can be achieved between the screen and PLC in a multi reassembly network.

### 3.2.3 Cable making

RJ45 Straight Through Cable (connected to HUB) or RJ45 Crossover Cable :



( Fig1 )



( Fig 2 )

### 3.2.4 Device address

Siemens S7-200smart series

PLC address type	Range	Object type	Notes
VB	0~9999	Byte	Variable Byte Data Register
VW	0~9999	Word	Variable Word Data Register
VD	0~9999	DWord	Variable Double Word Data Register
IB	0~15	Byte	External External input coil byte image register
IW	0~15	Word	External External input coil word image register
ID	0~15	DWord	External External input coil double word image register
QB	0~15	Byte	External External output coil byte image register
QW	0~15	Word	External External output coil word image register
QD	0~15	DWord	External External output coil double word image register
MB	0~31	Byte	Internal auxiliary byte register
MW	0~31	Word	Internal auxiliary word register
MD	0~31	DWord	Internal auxiliary double word register
SMB	0~299	Byte	Internal special auxiliary byte register
SMW	0~299	Word	Internal special auxiliary word register
SMD	0~299	DWord	Internal special auxiliary double word register
SB	0~31	Byte	Special auxiliary byte register
SW	0~31	Word	Special auxiliary word register
SD	0~31	DWord	Special auxiliary double word register
T	0~255	Word	Used as a register
C	0~255	Word	Used as a register
M	0.0~31.7	Bit	Bit register
V	0.0~9999.7	Bit	Variable register
I	0.0~15.7	Bit	External input coil
Q	0.0~15.7	Bit	External output coil
SM	0.0~299.7	Bit	Special sequence control relay
S	0.0~31.7	Bit	Sequence control relay
T	0~255	Bit	Timer
C	0~255	Bit	Counter

**Note:** Siemens VB/VW/VD selects the corresponding data type by changing the data type after selecting the V address.

### 3.3 Siemens S7-300 series Ethernet

#### 3.3.1 Device type

Series	Port	Cable making	PLC model in Touchwin software
S7-300	RJ45	Fig 1 or Fig 2	Siemens S7-300 series Ethernet

#### 3.3.2 Parameters

##### 1. PLC settings

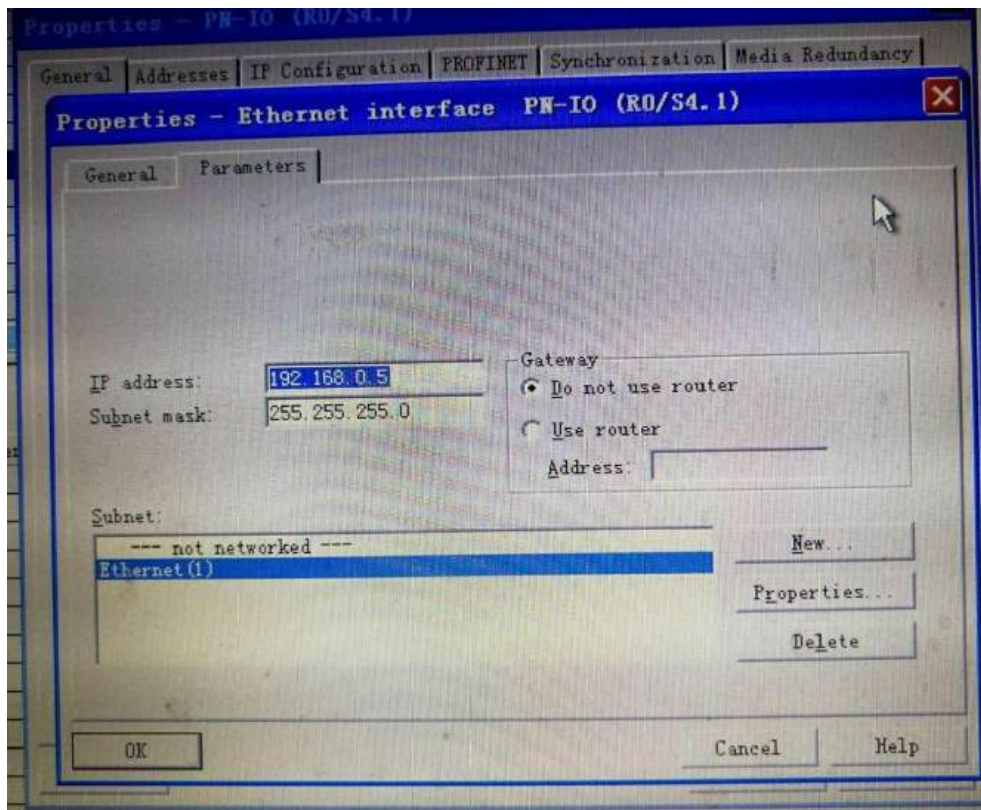

##### 2. HMI settings

- (1) After selecting the human-machine interface model as - E, click to proceed to the next step, select "Net1" in the device list, and set the IP address used for the human-machine interface in "Set Local IP", as long as it doesn't conflict with other IPs in the network.

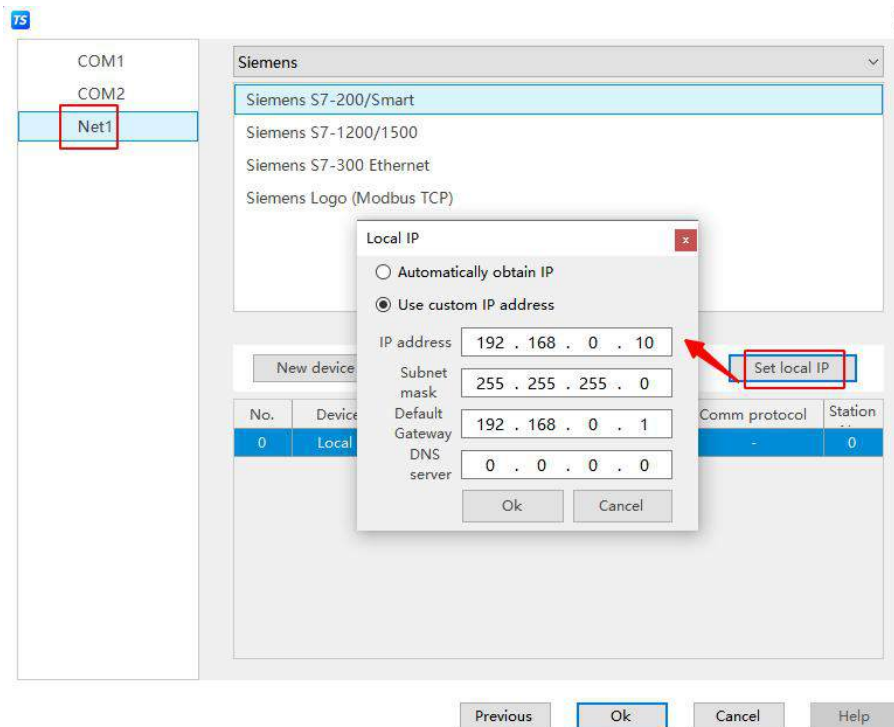

- (2) Click the drop-down button, select "Siemens" from the brand list, click the mouse to select "Siemens S7-300 series Ethernet", then select "New Device", and set the device name and IP communication parameters in the pop-up communication settings window. This IP address is the IP address of S7-300. In this example, the IP address of "Siemens S7-300" is "192.168.0.5", and the port number is fixed to 102, which cannot be modified. After setting up, click "Confirm":

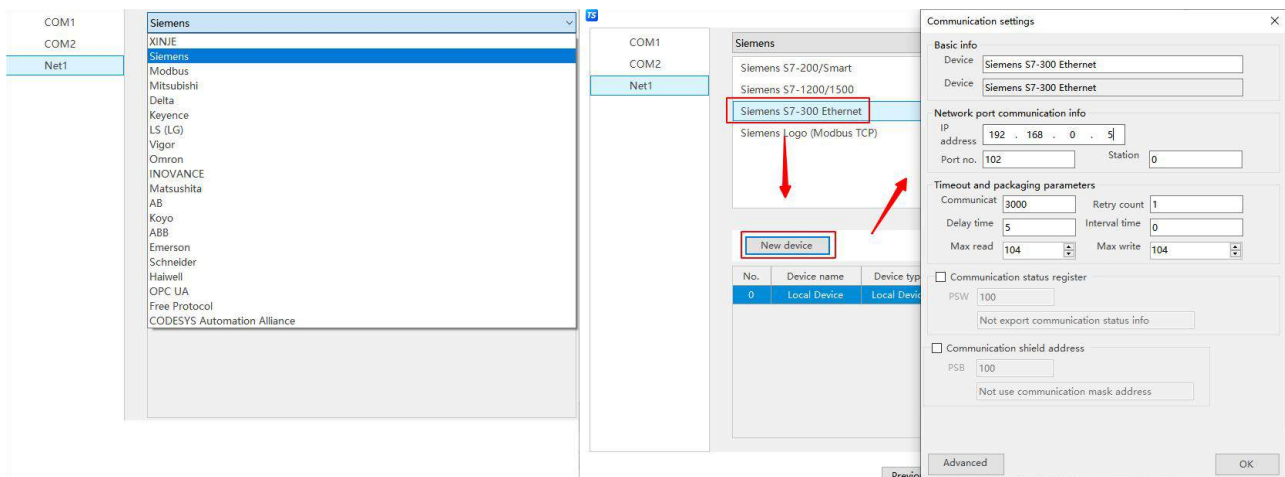

- (3) Check the "Communication Status Register" and PSW is set to 100 by default. PSW100~PSW103 represent the number of successful communication attempts, communication failures, communication timeouts, and communication errors, respectively. Customers can set this communication status register themselves.

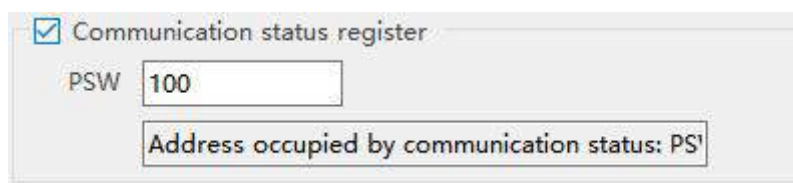

- (4) After setting up, click "Confirm" to end the setup and enter the screen editing interface. Place a data External input coil component on the screen, select the corresponding device "Siemens S7-300 series Ethernet" from

the device drop-down bar:

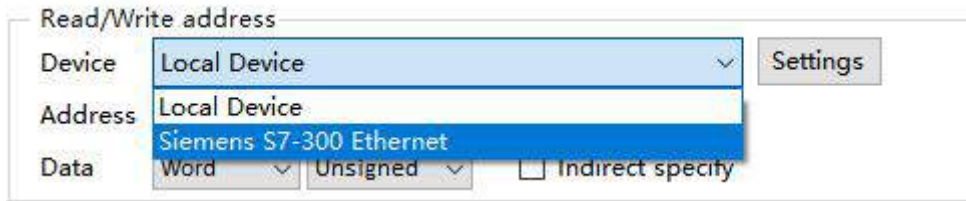

Siemens S7-300 doesn't have a station number issue, as long as the IP address is correct, it's sufficient. So, a multi screen one machine, one screen multiple machines, and multi screen multiple machines can be achieved between the screen and PLC in a multi reassembly network.

### 3.3.3 Cable making

RJ45 Straight Through Cable (connected to HUB) or RJ45 Crossover Cable :



( Fig1 )

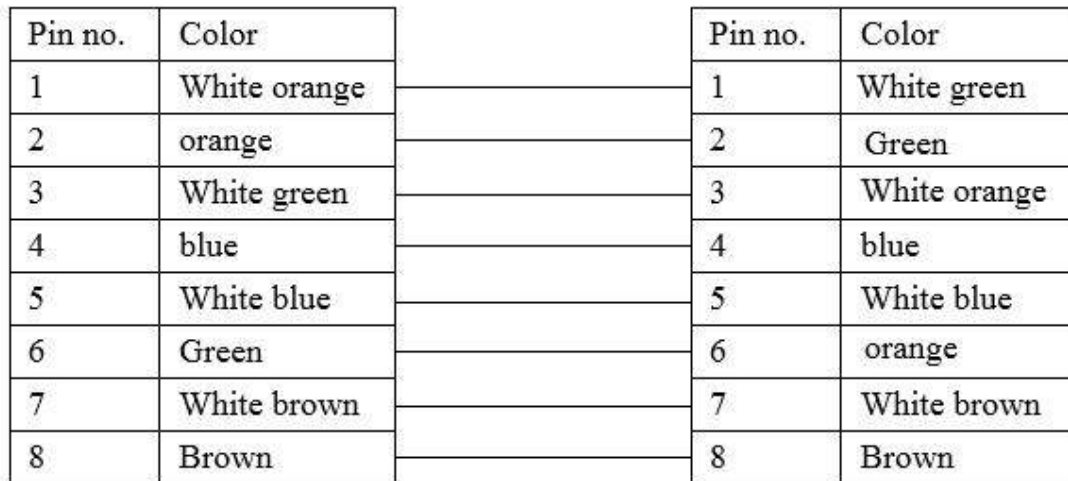

( Fig 2 )

### 3.3.4 Device address

Siemens S7-300 series

PLC address type	Range	Object type	Notes
VB	0~9999	Byte	Variable Byte Data Register
VW	0~9999	Word	Variable Word Data Register
VD	0~9999	DWord	Variable Double Word Data Register

IB	0~15	Byte	External External input coil byte image register
IW	0~15	Word	External External input coil word image register
ID	0~15	DWord	External External input coil double word image register
QB	0~15	Byte	External External output coil byte image register
QW	0~15	Word	External External output coil word image register
QD	0~15	DWord	External External output coil double word image register
MB	0~31	Byte	Internal auxiliary byte register
MW	0~31	Word	Internal auxiliary word register
MD	0~31	DWord	Internal auxiliary double word register
SMB	0~299	Byte	Internal special auxiliary byte register
SMW	0~299	Word	Internal special auxiliary word register
SMD	0~299	DWord	Internal special auxiliary double word register
SB	0~31	Byte	Special auxiliary byte register
SW	0~31	Word	Special auxiliary word register
SD	0~31	DWord	Special auxiliary double word register
T	0~255	Word	Used as a register
C	0~255	Word	Used as a register
M	0.0~31.7	Bit	Bit register
V	0.0~9999.7	Bit	Variable register
I	0.0~15.7	Bit	External input coil
Q	0.0~15.7	Bit	External output coil
SM	0.0~299.7	Bit	Special sequence control relay
S	0.0~31.7	Bit	Sequence control relay
T	0~255	Bit	Timer
C	0~255	Bit	Counter

**Note:** Siemens VB/VW/VD selects the corresponding data type by changing the data type after selecting the V address.

## 3.4 Siemens S7-1200/1500 series Ethernet

### 3.4.1 Device type

Series	Port	Cable making	PLC model in Touchwin software
S7-1200	RJ45	Fig 1 or Fig 2	Siemens S7-1200/1500 series
S7-1500			

### 3.4.2 Parameters

- Taking Siemens S7-1200 CPU1211C 6ES7 211-1BD30-0XB0 as an example, explain the communication settings of S7-1200.

#### 1. PLC settings

- (1) Open the Project - Devices and Networks - General - Ethernet Address interface, and set the PLC IP address:

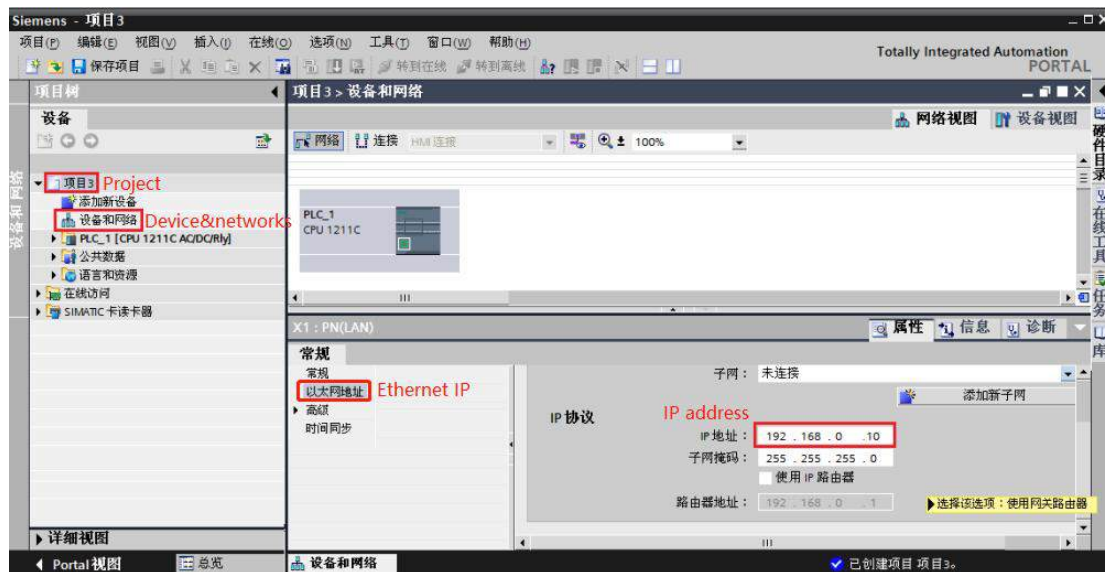

- (2) PLC DB and M must be defined in the PLC before they can be used. The definition steps are as follows: select Project - Program Block - Add New Block, select Data Block (DB), and select the type as Global D.
- (3) B, don't check "Symbol Access Only", the DB number can be automatically incremented or manually set, as shown in the following figure:



- (4) Select Project - Program Block - Data Block to define the actionable addresses within the selected data block, as shown in the following figure:

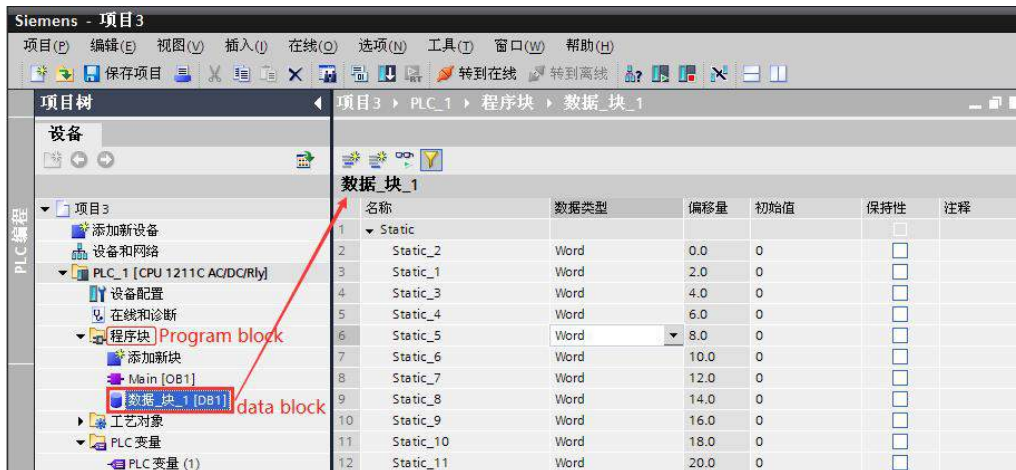

- (5) The default option for data blocks is "optimized block access". To uncheck this option, select Project - Program Block - Data Block, right-click on a single mouse, and select "Properties":

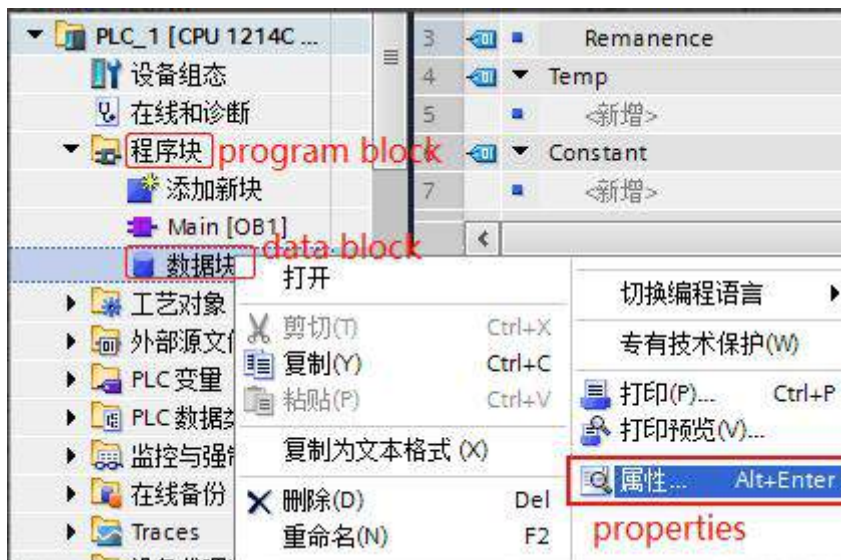

Select the attribute in the pop-up window and uncheck the "Optimized Block Access" option:

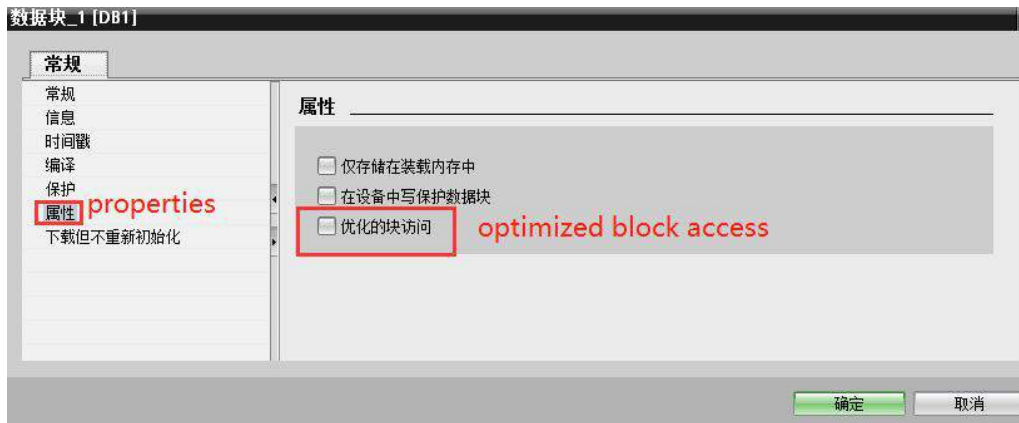

**Note:** For Siemens programming software STEP Basic V12 and above, the connection mechanism has been added to allow communication access. Communication protection can be removed by the following methods:

(1) Select the PLC used for programming in the project tree, right-click, and select "Properties":

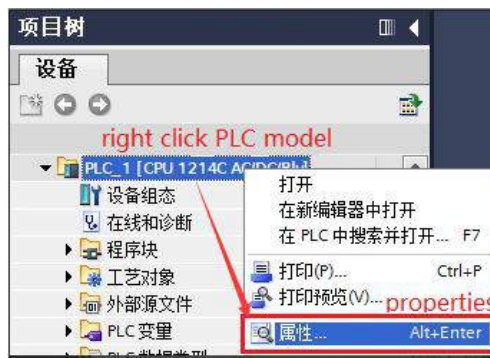

(2) The system will open a window as shown in the figure below, select protection, check the "Allow access from remote software (PLC, HMI, OPC,...) using PUT/GET communication" under the connection mechanism, and download it to the PLC with the program after setting.

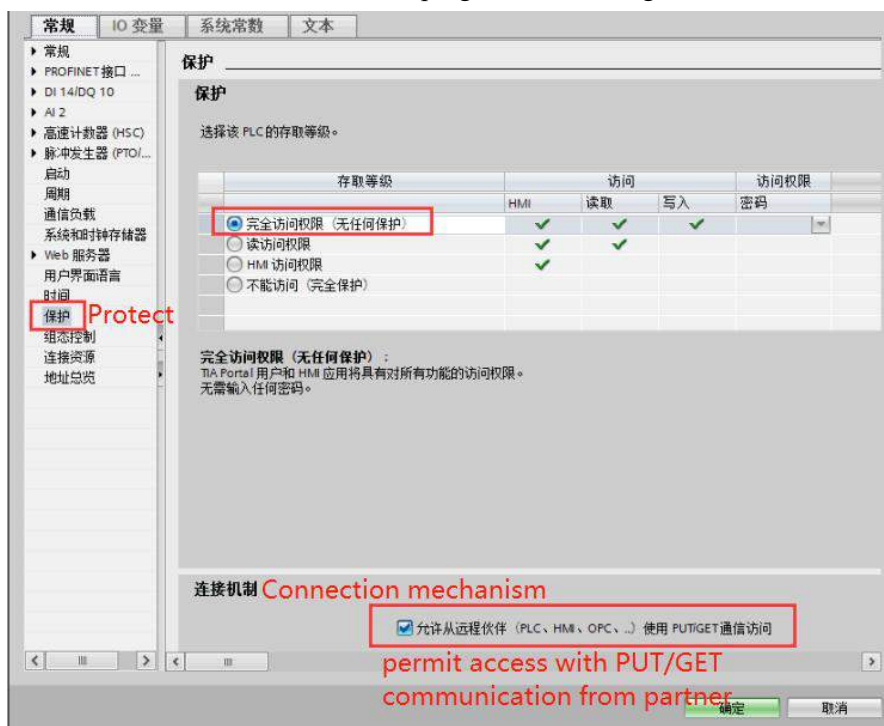

■ Explanation of S7-1500 communication settings

1. PLC settings

(1) Open project-devices&networks-normal-Ethernet IP, set the PLC IP address:

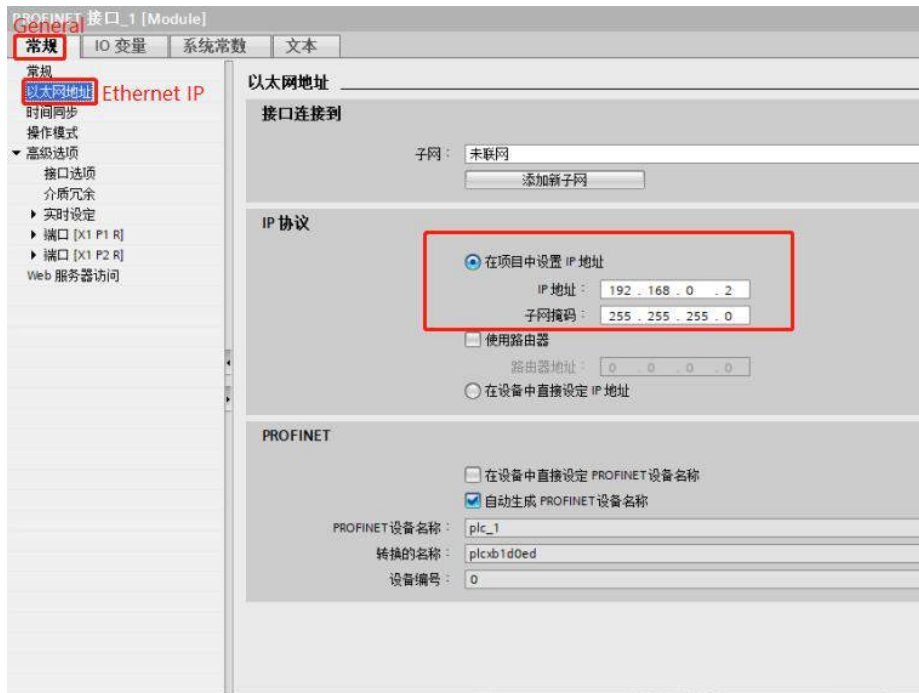

(2) Check the attribute settings below to access DB from OPC UA.

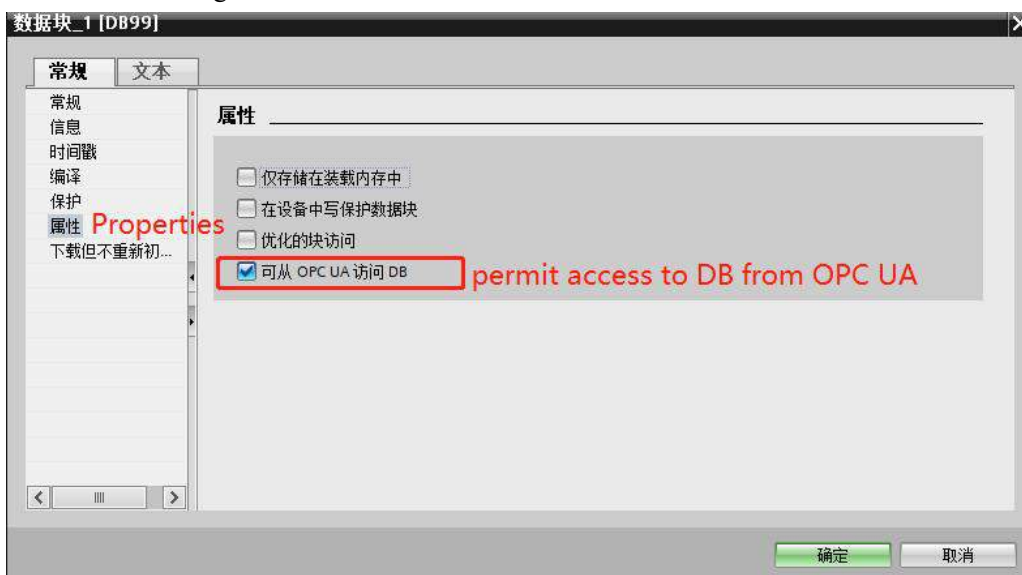

(3) Please choose “permit access with PUT/GET communication from remote partner”.



(4) Set access level-HMI access rights/full access.

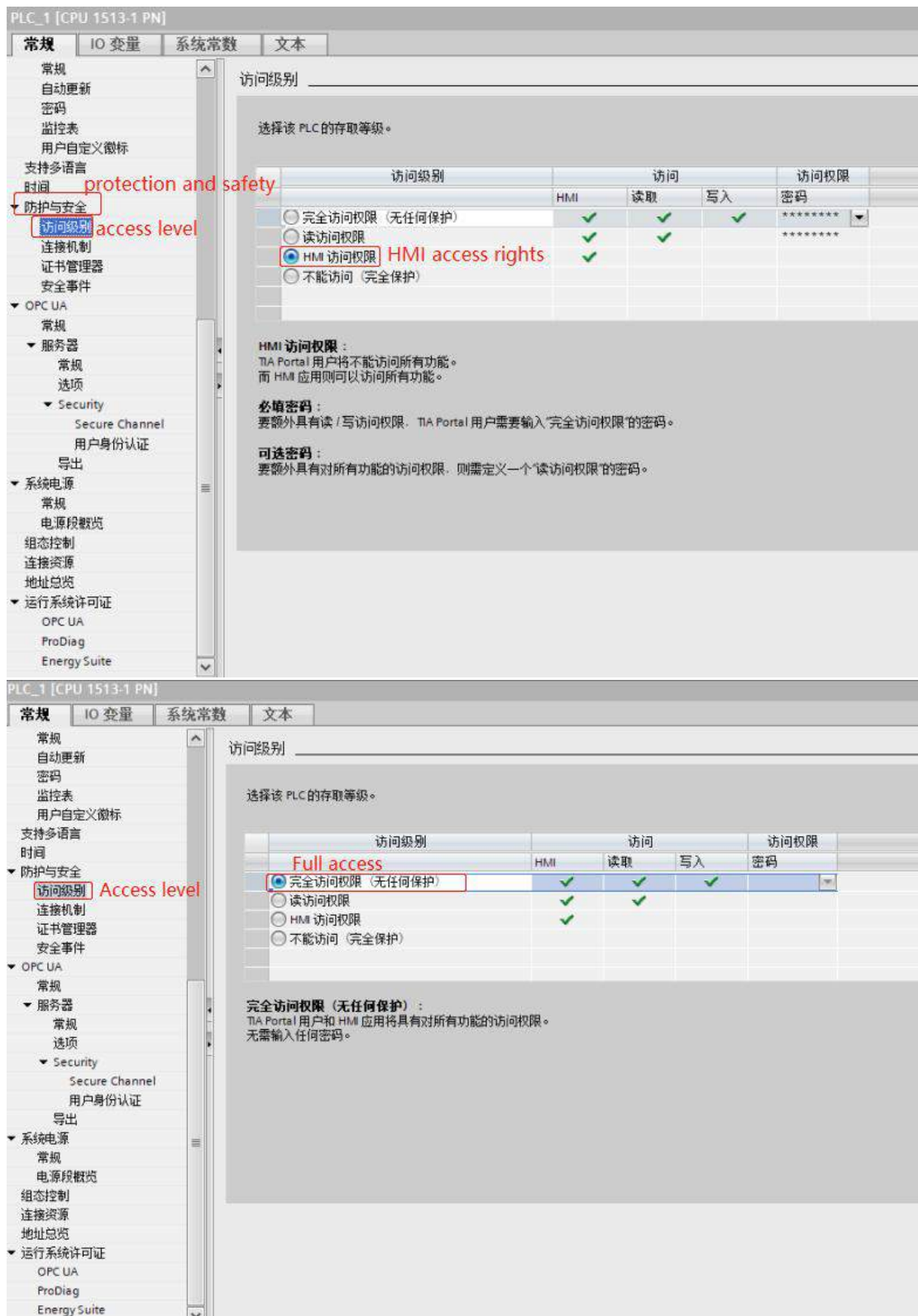

## 2. HMI settings

- (1) After selecting the human-machine interface model as - E, click to proceed to the next step, select "Net1" in the device list, and set the IP address used for the human-machine interface in "Set Local IP", as long as it doesn't conflict with other IPs in the network.

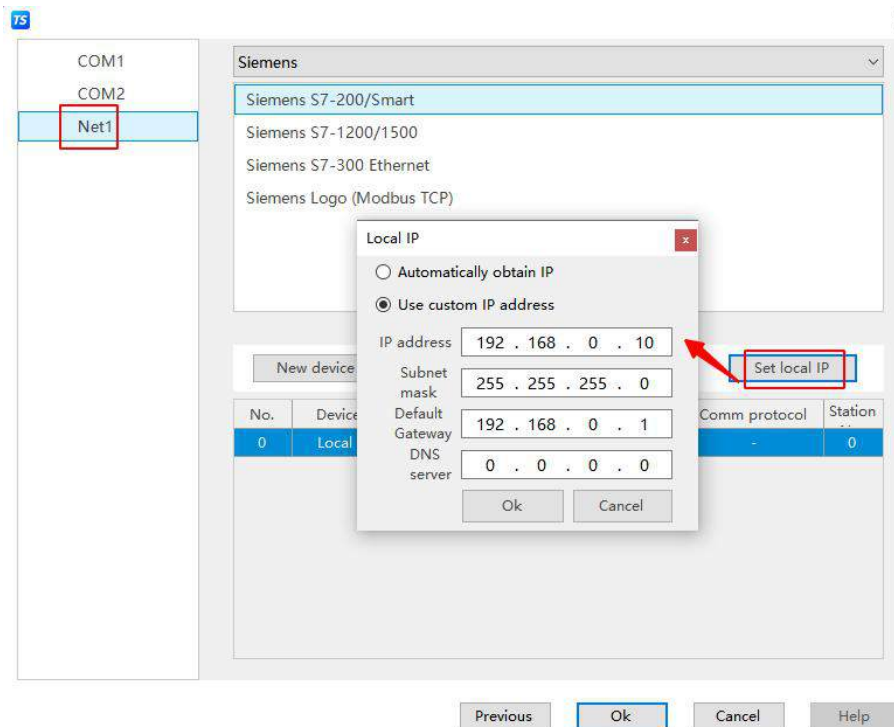

- (2) Click the drop-down button, select "Siemens" from the brand list, click the mouse to select "Siemens S7-1200/1500 series", then select "New Device", and set the device name and IP communication parameters in the pop-up communication settings window. This IP address is the IP address of S7-1200. In this example, the IP address of "Siemens S7-1200" is "192.168.0.30", and the port number is fixed to 102 and cannot be modified. After setting up, click "Confirm":

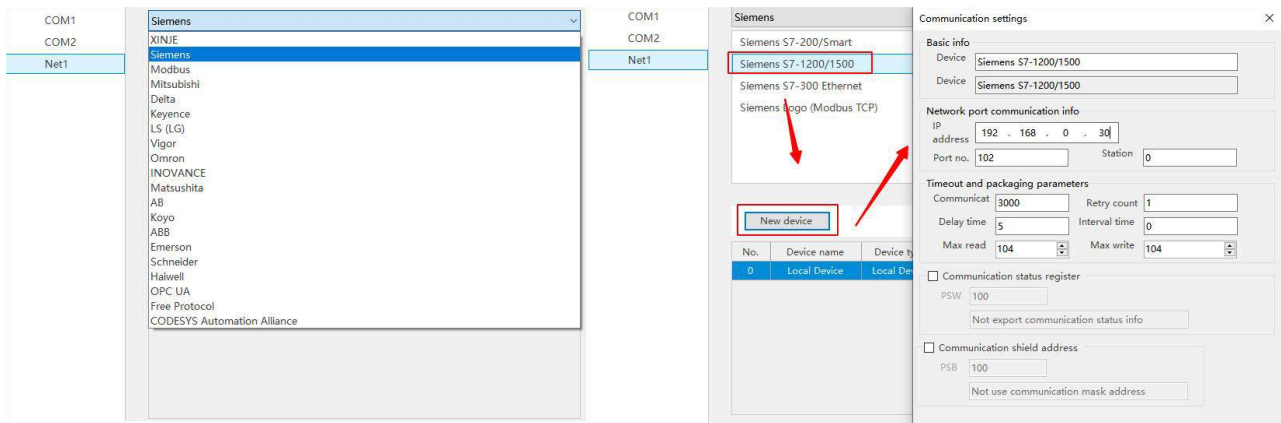

- (3) Check the "Communication Status Register" and PSW is set to 100 by default. PSW100~PSW103 represent the number of successful communication attempts, communication failures, communication timeouts, and communication errors, respectively. Customers can set this communication status register themselves.

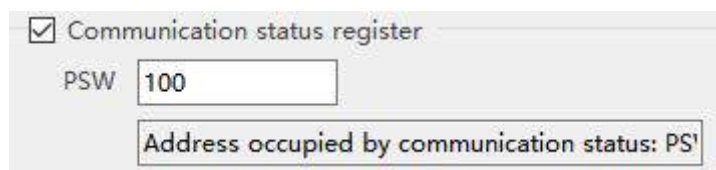

After setting up, click "Confirm" to end the setup and enter the screen editing interface. Place a data External input coil component on the screen, select the corresponding device "Siemens S7-1200/1500 series" from the device drop-down menu:

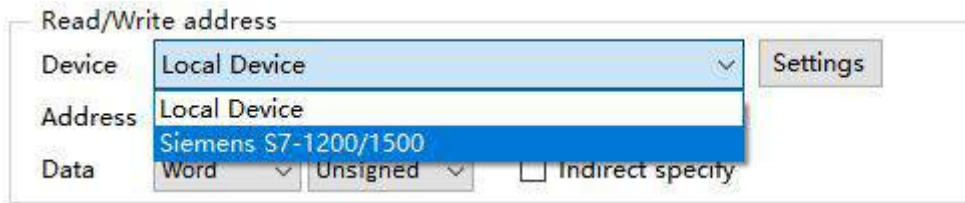

There is no station number issue with Siemens S7-1200, as long as the IP address is correct. So, a multi screen one machine, one screen multiple machines, and multi screen multiple machines can be achieved between the screen and PLC in a multi reassembly network.

**Note:**

( 1 )DB and M must be defined in the PLC before they can be used, otherwise communication may not be possible.

( 2 )When communication is successful, the RX/TX light on S7-1200 should be constantly on, flashing to indicate that the network is being searched.

### 3.4.3 Cable making

RJ45 Straight Through Cable (connected to HUB) or RJ45 Crossover Cable :

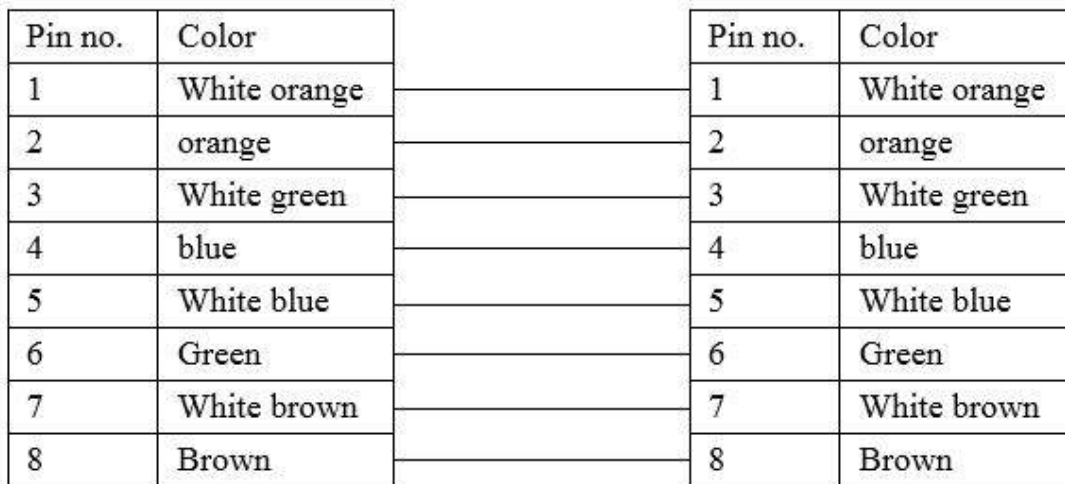

( Fig1 )

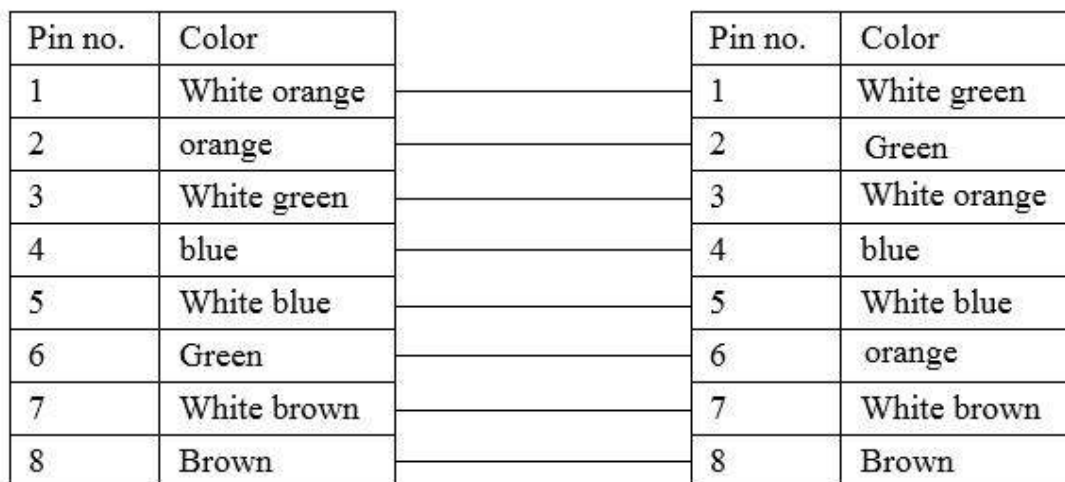

( Fig 2 )

---

### 3.4.4 Device address

PLC address type	Range	Object type	Notes
I	0~9999	Byte/Word/DWord	External input coil register
Q	0~9999	Byte/Word/DWord	External output coil register
M	0~9999	Byte/Word/DWord	Internal auxiliary register
DB0~DB20	0~9999	Byte/Word/DWord	Data register
I	0.0~9999.7	Bit	External input coil
Q	0.0~9999.7	Bit	External output coil
M	0.0~9999.7	Bit	Auxiliary relay
DB0~DB20	0.0~9999.7	Bit	Auxiliary relay

## 3.5 Siemens LOGO (Modbus TCP)

### 3.5.1 Device type

Series	Port	Cable making	PLC model in Touchwin software
LOGO	RJ45	Fig 1 or Fig 2	Siemens LOGO( Modbus TCP )

### 3.5.2 Parameters

- With Siemens logo! Taking 24CEo 6ED1 052-2CC08-0BA1 as an example, explain the logo communication settings.

#### 1. PLC settings

- (1) Open the basic settings and set the PLC IP address:

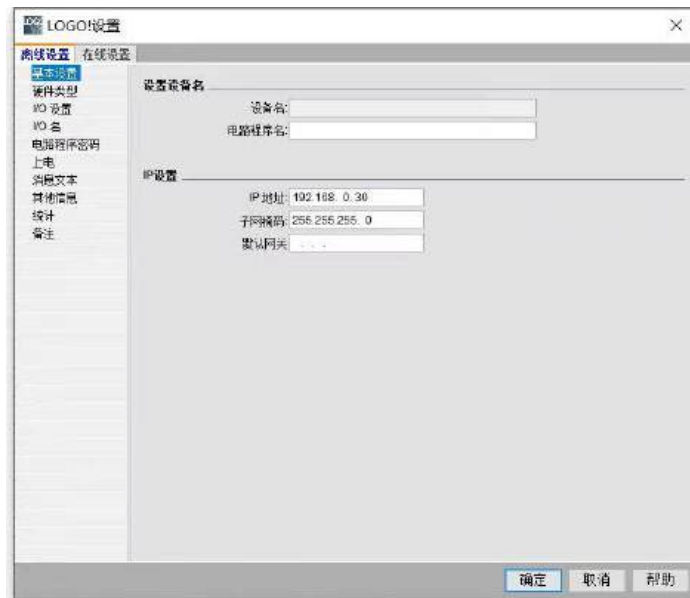

#### 2. HMI settings

- (1) After selecting the human-machine interface model as - E, click to proceed to the next step, select "Net1" in the device list, and set the IP address used for the human-machine interface in "Set Local IP", as long as it doesn't conflict with other IPs in the network.

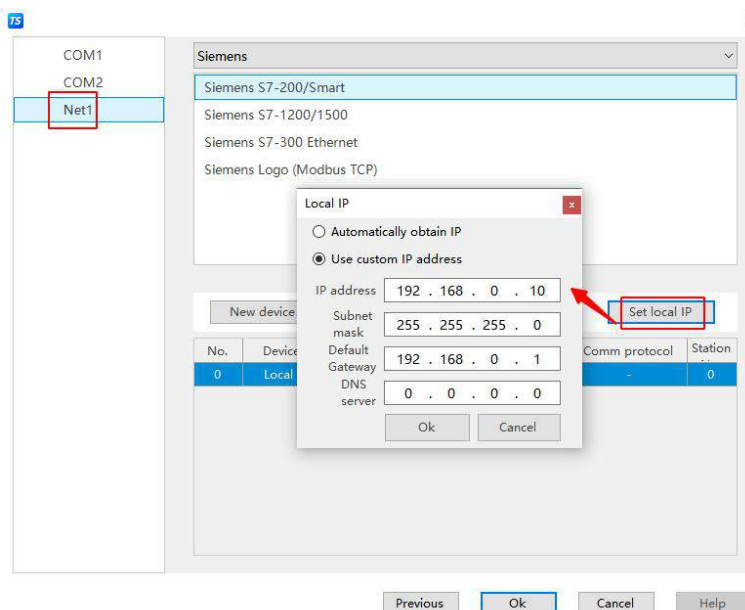

- (2) Click the drop-down button, select "Siemens" from the brand list, click the mouse to select "Siemens LOGO (Modbus TCP)", then select "New Device", and set communication parameters such as device name and IP in the pop-up communication settings window. This IP address is the IP address of Siemens LOGO. In this example, the IP address of "Siemens LOGO" is "192.168.0.30", and the port number is fixed as 502, which cannot be modified. After setting up, click "Confirm":

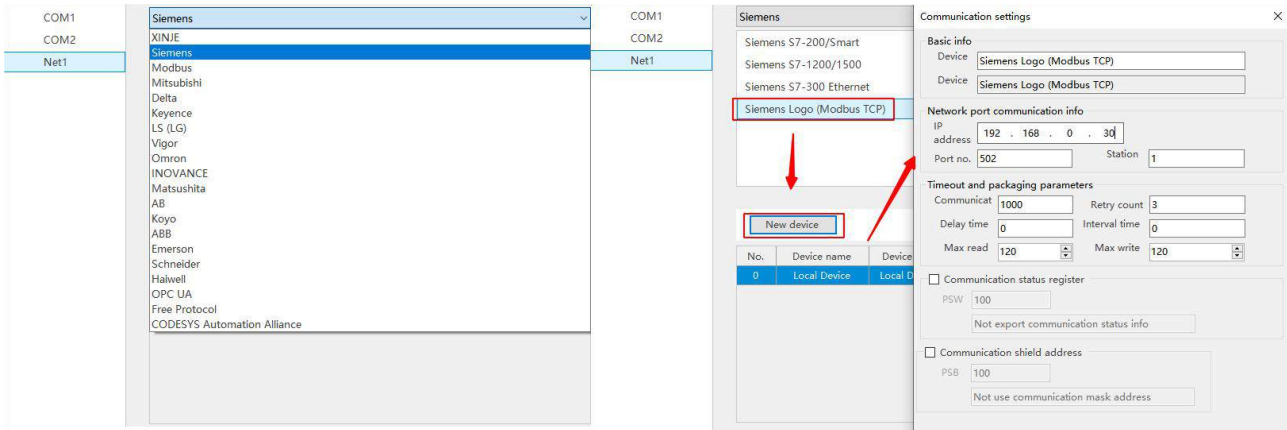

- (3) Check the "Communication Status Register" and PSW is set to 100 by default. PSW100~PSW103 represent the number of successful communication attempts, communication failures, communication timeouts, and communication errors, respectively. Customers can set this communication status register themselves.



- (4) After setting up, click "Confirm" to end the setup and enter the screen editing interface. Place a data External input coil component on the screen and select it from the device drop-down bar, select the corresponding device "Siemens LOGO (Modbus TCP)":

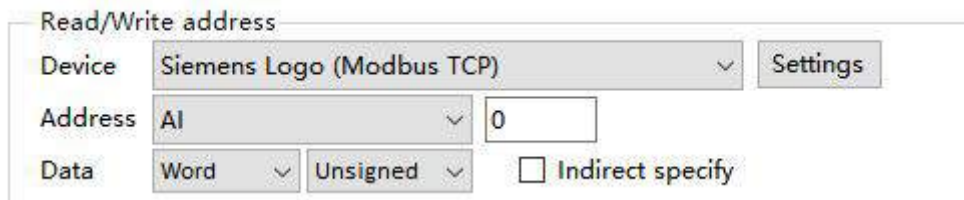

### 3.5.3 Cable making

RJ45 Straight Through Cable (connected to HUB) or RJ45 Crossover Cable :

Pin no.	Color		Pin no.	Color
1	White orange	—	1	White orange
2	orange	—	2	orange
3	White green	—	3	White green
4	blue	—	4	blue
5	White blue	—	5	White blue
6	Green	—	6	Green
7	White brown	—	7	White brown
8	Brown	—	8	Brown

( Fig1 )

Pin no.	Color		Pin no.	Color
1	White orange	—	1	White green
2	orange	—	2	Green
3	White green	—	3	White orange
4	blue	—	4	blue
5	White blue	—	5	White blue
6	Green	—	6	orange
7	White brown	—	7	White brown
8	Brown	—	8	Brown

( Fig 2 )

### 3.5.4 Device address

PLC address type	Range	Object type	Notes
AI	0~8	Word	External input coil register
AQ	0~8	Word	External output coil register
AW	0~425	Word	Internal auxiliary register
AM	0~64	Word	Data register
I	0~24	Bit	External input coil
Q	0~20	Bit	External output coil
M	0~64	Bit	Auxiliary relay
V	0~6808	Bit	Auxiliary relay

**Note:** Siemens VB/VW/VD selects the corresponding data type by changing the data type after selecting the V address.

---

## 4 Modbus device connection instructions

This chapter mainly introduces the connection instructions between the touch screen and the Modbus universal external communication device.

**Note:**

- ( 1 )The Xinje TS series touch screen supports a maximum baud rate of 187.5K.**
- ( 2 )During communication, please don't plug or unplug cables with power, as it may cause damage to the device's serial port.**
- ( 3 )Upgrade of touch screen software version, there may be some changes in the communication protocol device address range. The device address range in the software shall prevail.**

### 4.1 Modbus RTU( Master )

#### 4.1.1 Device type

Series	Port	Cable making	PLC model in Touchwin software
Devices that support Modbus RTU protocol	RS485	Fig 1	Modbus RTU( HMI is Master )
	RS232	Fig 2	
	RS422	Fig 3	

#### 4.1.2 Parameters

##### 1. HMI settings

Parameter	Recommend settings	Choices of settings	Note
PLC type	Modbus RTU ( HMI is Master )		None
Port	RS485	RS485/RS232/RS422	
Data bit	8		
Stop bit	1	1/2	
Parity	Even parity	Even parity/Odd parity /None Parity	
Baud rate	9600	4800/38400/9600/115200/19200/187500	
Station No.	1	0~255	

Modbus RTU (HMI is Master) protocol default communication parameters:

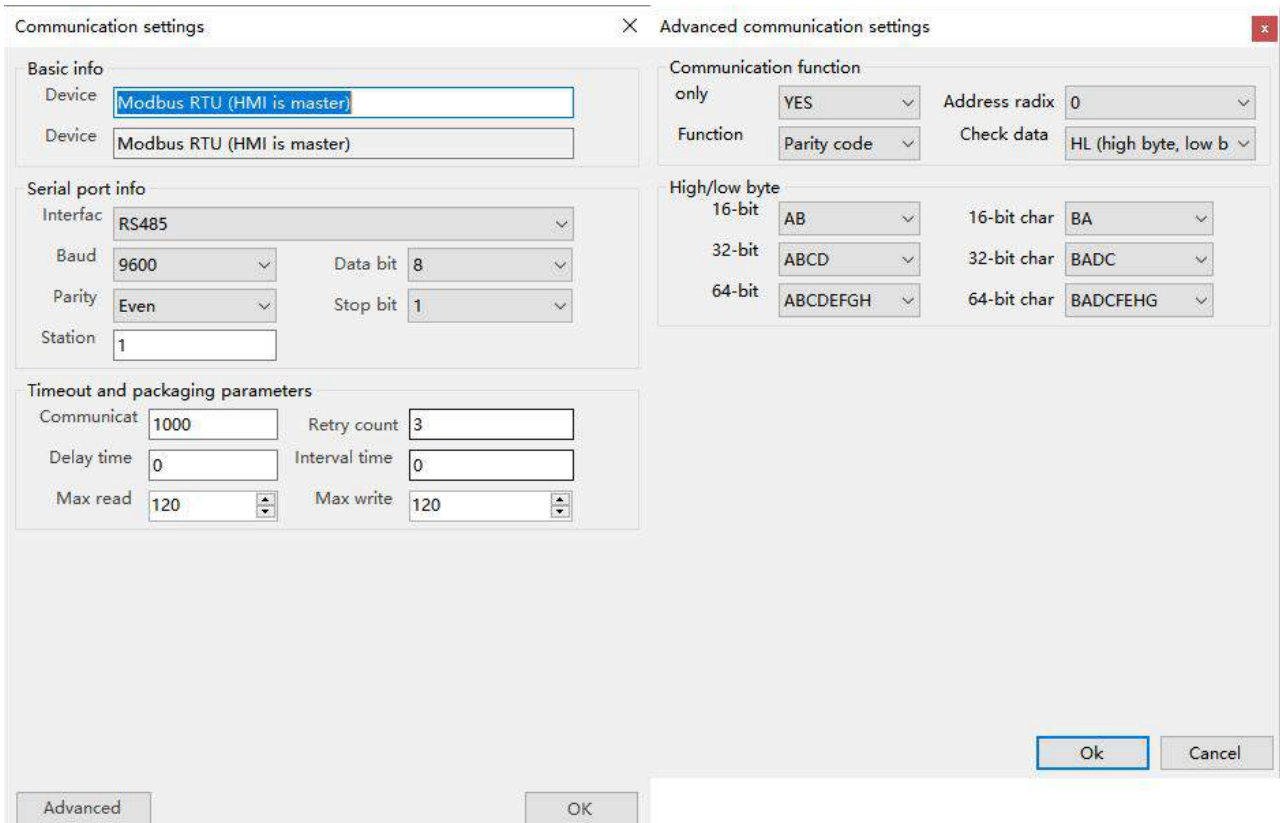

**Note:**

- ( 1 )The Modbus RTU protocol supports broadcasting function, with station number 0.
- ( 2 )Using the broadcast function in the touch screen: Since the broadcast function only sends commands without returning them, only "function keys", "function fields", or "function blocks" can be used to send commands to external devices in the touch screen. The object being operated on must be a writable component that doesn't require returning commands, such as a "set coil", "set data", "reset coil", etc.

2. PLC settings

Select the Modbus RTU (Slave) protocol in the software.

4.1.3 Cable making

- 1. RS485 communication line:

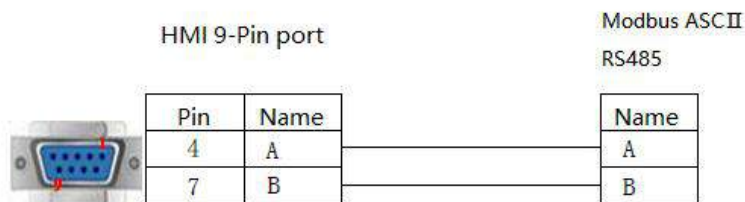

( Fig1 )

- 2. RS232 communication line:

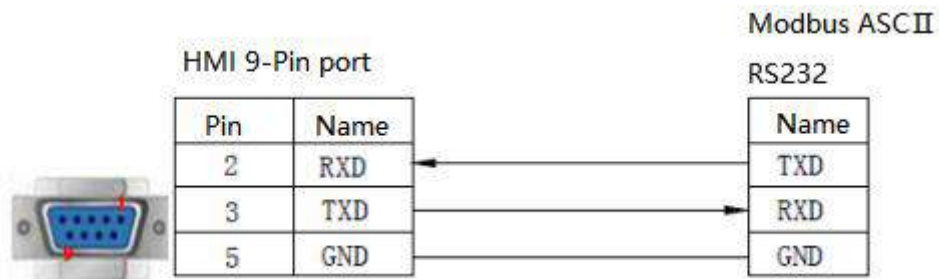

( Fig 2 )

3. RS422 communication line:

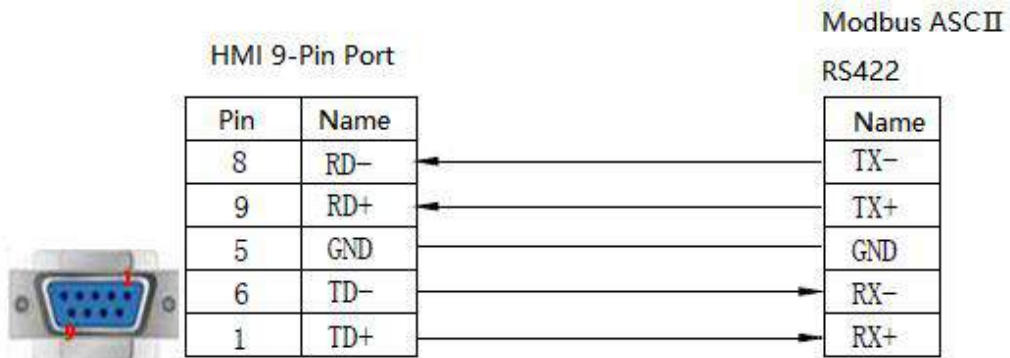

( Fig 3 )

#### 4.1.4 Device address

Device address type	Range	Object type	Attribute	Notes
0x	0~65535	Bit	R/W	External input coil/External output coil/internal coil
1x	0~65535	Bit	R	External input coil/External output coil/internal coil
4x	0.00~65535.15	Bit	R/W	External input coil/External output coil/internal coil
4x	0~65535	Word/Dword	R/W	Data register
3x	0~65535	Word/Dword	R	Data register

## 4.2 Modbus ASCII( Master )

### 4.2.1 Device type

Series	Port	Cable making	PLC model in Touchwin software
Devices that support Modbus ASCII protocol	RS485	Fig 1	Modbus ASCII ( HMI is Master )
	RS232	Fig 2	
	RS422	Fig 3	

### 4.2.2 Parameters

#### 1. HMI settings

Parameter	Recommend settings	Choices of settings	Note
PLC type	Modbus ASCII ( HMI is Master )		None
Port	RS485	RS485/RS232/RS422	
Data bit	7		
Stop bit	1	1/2	
Parity	Even parity	Even parity/Odd parity /None Parity	
Baud rate	9600	4800/38400/9600/115200/19200/187500	
Station No.	1	0~255	

Modbus ASCII (HMI is Master) protocol default communication parameters:

The screenshot shows the 'Advanced communication settings' dialog box. The 'Communication settings' pane is active, showing the following configurations:

- Basic info:** Device: Modbus ASCII (HMI is master)
- Serial port info:** Interface: RS485, Baud: 9600, Data bit: 7, Parity: Even, Stop bit: 1, Station: 1
- Timeout and packaging parameters:** Communicat: 1000, Retry count: 3, Delay time: 0, Interval time: 0, Max read: 120, Max write: 120

The 'Advanced communication settings' pane shows:

- Communication function:** only: YES, Function: Parity code, Address radix: 0, Check data: HL (high byte, low b)
- High/low byte:**
  - 16-bit: AB, 16-bit char: BA
  - 32-bit: ABCD, 32-bit char: BADC
  - 64-bit: ABCDEFGH, 64-bit char: BADCFEHG

#### 2. PLC settings

Select the Modbus ASCII (Slave) protocol in the software.

### 4.2.3 Cable making

1. RS485 communication line:

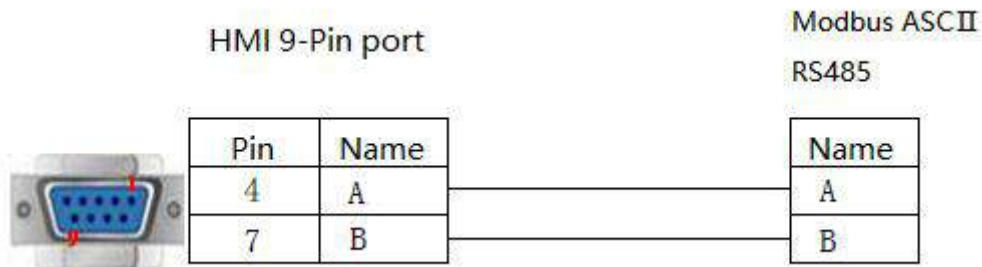

( Fig1 )

2. RS232 communication line:

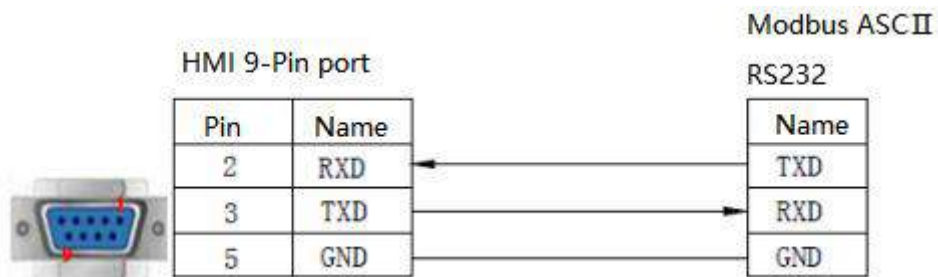

( Fig 2 )

3. RS422 communication line:

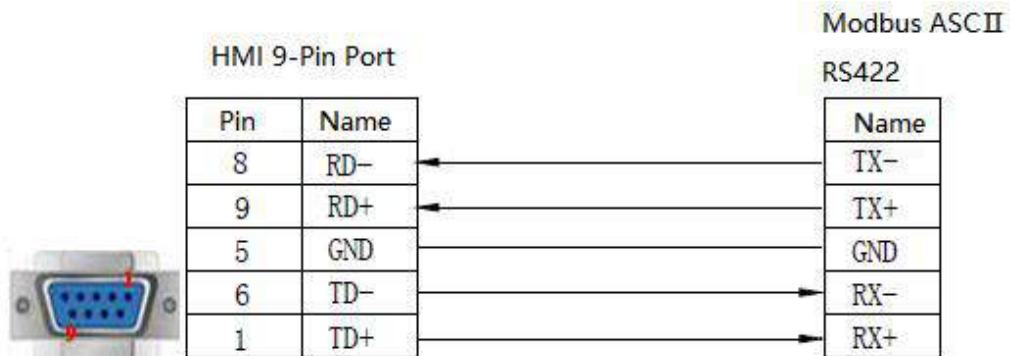

( Fig 3 )

### 4.2.4 Device address

Device address type	Range	Object type	Attribute	Notes
0x	0~65535	Bit	R/W	External input coil/External output coil/internal coil
1x	0~65535	Bit	R	External input coil/External output coil/internal coil
4x	0~65535	Word/Dword	R/W	Data register
3x	0~65535	Word/Dword	R	Data register

## 4.3 Modbus RTU (Slave)

### 4.3.1 Device type

Series	Port	Cable making	PLC model in Touchwin software
Devices that support the Modbus protocol	RS485	Fig1	Modbus slave device (HMI is Slave)
	RS232	Fig 2	
	RS422	Fig 3	

### 4.3.2 Parameters

#### 1, HMI settings

Parameter	Recommend settings	Choices of settings	Note
PLC type	Modbus slave device (HMI is Slave)		None
Port	RS485	RS485/RS232/RS422	
Data bit	8	7/8	
Stop bit	1	1/2	
Parity	Even parity	Even parity/Odd parity /None Parity	
Baud rate	9600	4800/38400/9600/115200/19200/187500	
Station No.	1	0~255	

Modbus slave device (HMI is Slave) protocol default communication parameters:

### 4.3.3 Cable making

1. RS485 communication line:

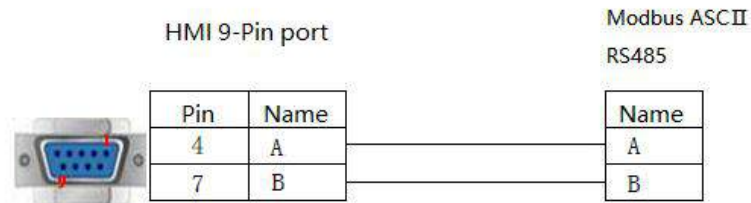

( Fig1 )

2. RS232 communication line:

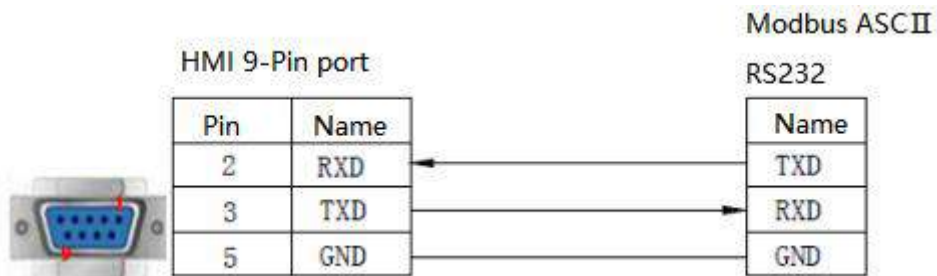

( Fig 2 )

3. RS422 communication line:

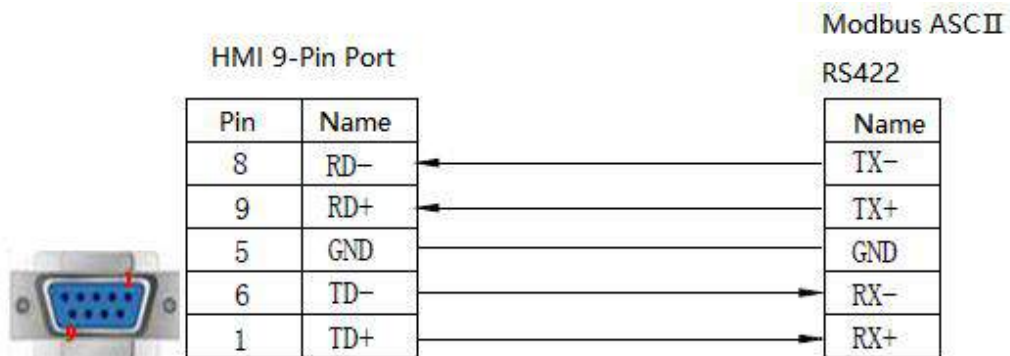

( Fig 3 )

### 4.3.4 Device address

Device address type	Range	Object type	Attribute	Modbus address
PSB	0~9999	Bit	R/W	0~9999
PSW	0.00~9999.15	Bit	R/W	0.00~9999.15
PFW	0.00~55535.15	Bit	R/W	10000.00~65535.15
PSW	0~9999	Word/Dword	R/W	0~9999
PFW	0~55535	Word/Dword	R/W	10000~65535
PSB	0~9999	Bit	R/W	0~9999

a. The internal objects of the touch screen include PSB, PSW, and PFW:

Object type	Note
PSB	Representing bit objects
PSW	Represents a non power outage hold word object
PFW	Object representing power outage hold word

---

b. The range of internal objects that can be used for each model:

The number and range of PSB, PSW, and PFW data can be modified through " File / System Settings / Display / Parameter Settings".

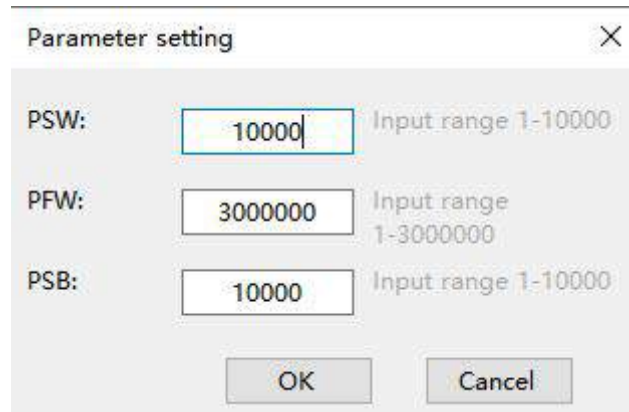

c. Special address usage inside the touch screen

SPSW, SPFW, and SPSB are used as special system functions and don't participate in communication.

## 4.4 Modbus TCP( Master )

### 4.4.1 Device type

Series	Port	Cable making	PLC model in Touchwin software
Ethernet port communication device supporting Modbus TCP protocol	RJ45	Fig 1 or Fig 2	Modbus TCP device (HMI is Master) (Devices with lower machine site number 0 are not supported)

### 4.4.2 Parameters

Take Xinje XD5E as an example to explain the Modbus TCP parameter setting.

#### 1. PLC settings

- (1) Connect the PLC to the computer, open the PLC programming software, open the PLC configuration in the engineering column on the left side of the software, double-click the "Ethernet port" below, manually set the Ethernet parameters of PLC in the pop-up configuration window, and click "write to PLC" after setting:

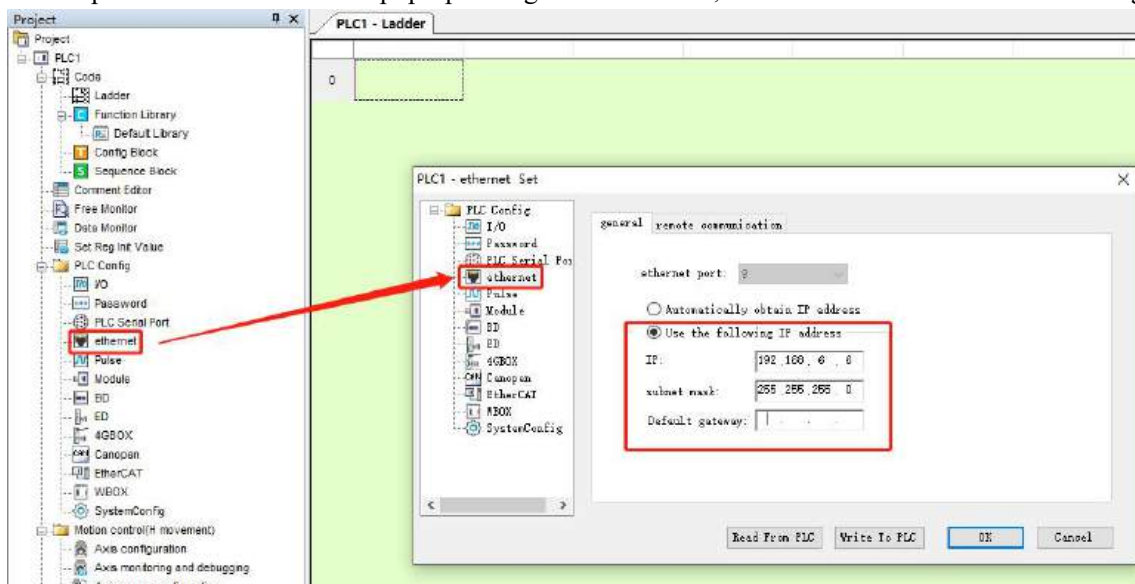

**Note:** After the parameter is written, the PLC needs to be restarted to take effect.

#### 2. HMI settings

- (1) After selecting the human-machine interface model as - E, click to proceed to the next step, select "Net1" in the device list, and set the IP address used for the human-machine interface in "Set Local IP", as long as it doesn't conflict with other IPs in the network.

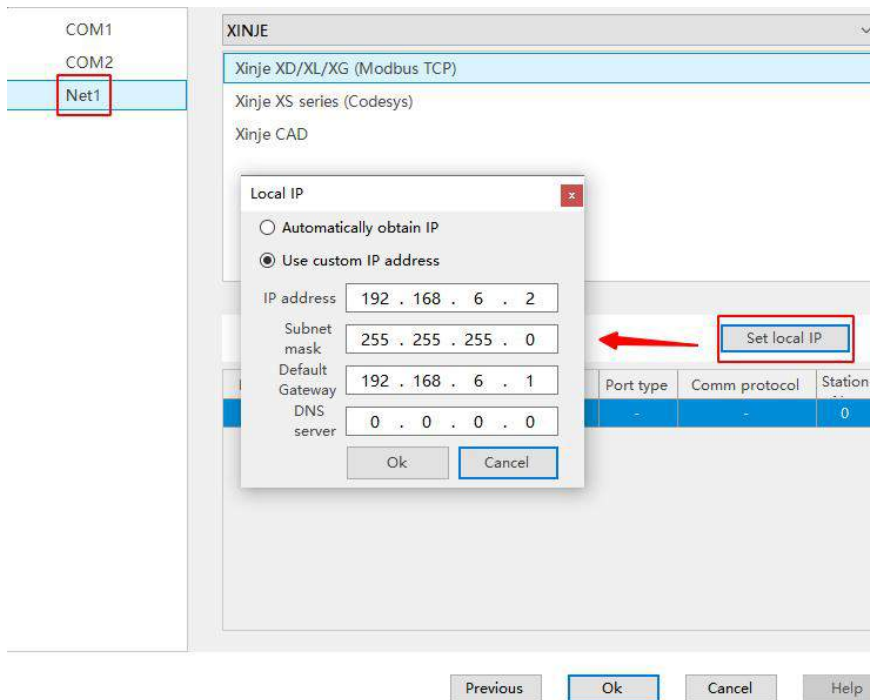

- (2) Click the drop-down button, select "Modbus\_General" in the brand list, click on "Modbus TCP (HMI is Master)" in the model list with the mouse, then select "New Device", and set communication parameters in the pop-up communication settings window. This IP address is the IP address of the communication device (which can be set through PLC software), and the port number is fixed to 502 and cannot be modified. After setting up, click "Confirm".

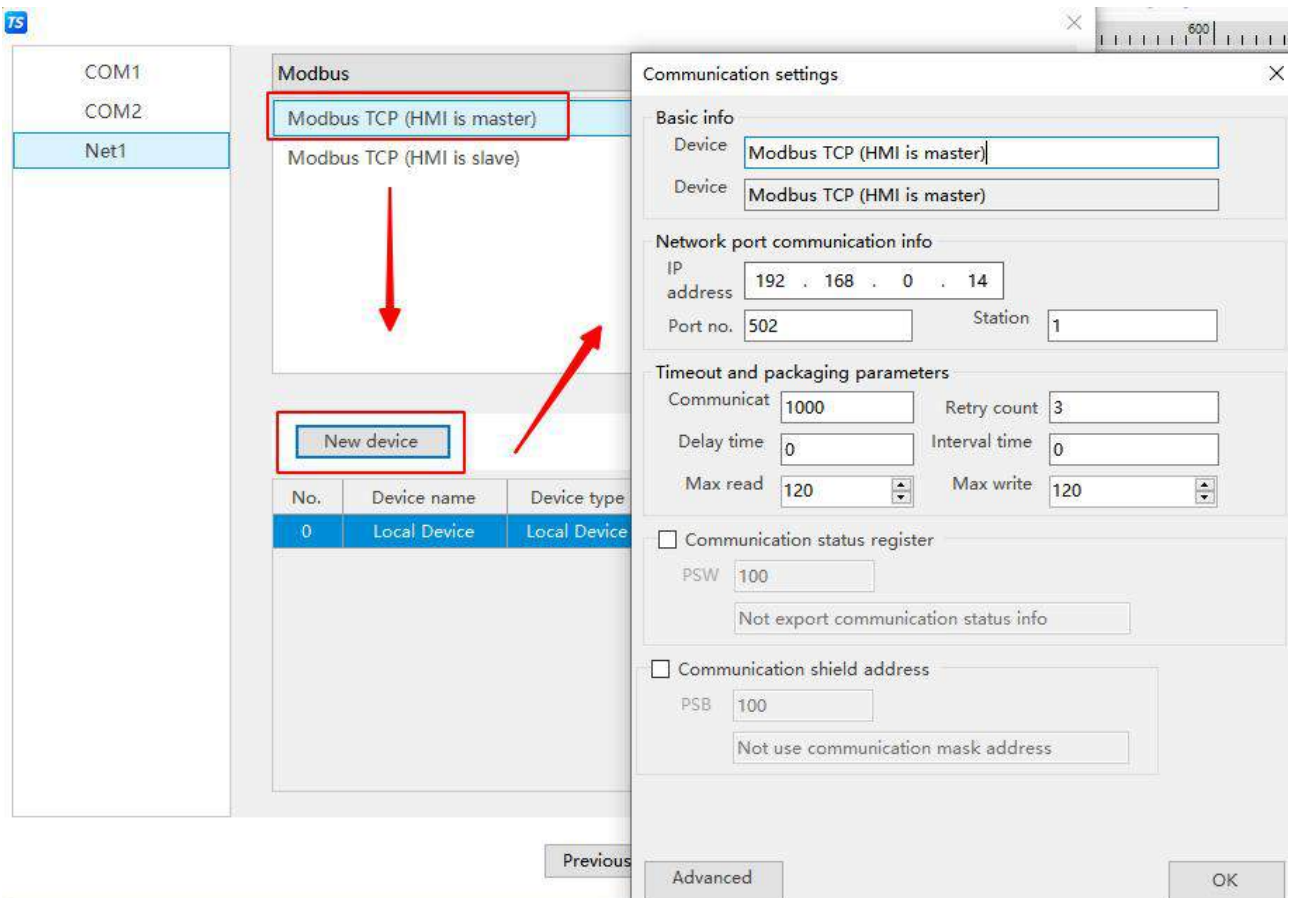

- (3) Check the "Communication Status Register" and PSW is set to 100 by default. PSW100~PSW103 represent the number of successful communication attempts, communication failures, communication timeouts, and

communication errors, respectively. Customers can set this communication status register themselves.



- (4) After setting up, click "Confirm" to end the setup and enter the screen editing interface. Place a data External input coil component in the screen, select "Modbus TCP (Display as Master)" from the device drop-down menu, object type is modbus address, word object is 4x (Read Write), 3x (Read Only), bit object is 0xx (Read Write), 1x (Read Only):

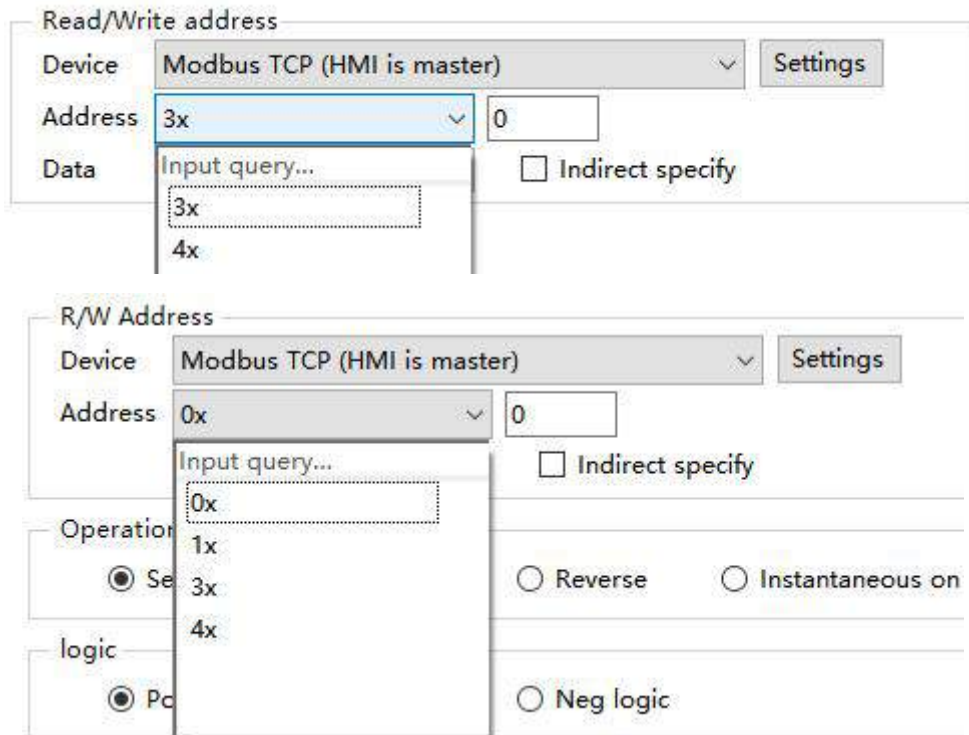

- (5) After programming, download it to the screen to achieve touch screen control of remote PLC and other devices through Ethernet.

#### 4.4.3 Cable making

RJ45 Straight Through Cable (connected to HUB) or RJ45 Crossover Cable :

Pin no.	Color		Pin no.	Color
1	White orange	—————	1	White orange
2	orange	—————	2	orange
3	White green	—————	3	White green
4	blue	—————	4	blue
5	White blue	—————	5	White blue
6	Green	—————	6	Green
7	White brown	—————	7	White brown
8	Brown	—————	8	Brown

( Fig1 )

Pin no.	Color		Pin no.	Color
1	White orange	—————	1	White green
2	orange	—————	2	Green
3	White green	—————	3	White orange
4	blue	—————	4	blue
5	White blue	—————	5	White blue
6	Green	—————	6	orange
7	White brown	—————	7	White brown
8	Brown	—————	8	Brown

( Fig 2 )

#### 4.4.4 Device address

Device address type	Range	Object type	Attribute	Notes
0x	0~65535	Bit	R/W	External input coil / External output coil / internal coil
1x	0~65535	Bit	R	External input coil / External output coil / internal coil
4x	0.00~65535.15	Bit	R/W	External input coil / External output coil / internal coil
4x	0~65535	Word/Dword	R/W	Data register
3x	0~65535	Word/Dword	R	Data register

## 4.5 Modbus TCP (Slave)

### 4.5.1 Device type

Series	Port	Cable making	PLC model in Touchwin software
Ethernet port communication device supporting Modbus TCP protocol	RJ45	Fig 1 or Fig 2	Modbus TCP(HMI is Slave)

### 4.5.2 Parameters

Modbus slave device (HMI is Slave) protocol default communication parameters:

### 4.5.3 Cable making

RJ45 Straight Through Cable (connected to HUB) or RJ45 Crossover Cable :

Pin no.	Color		Pin no.	Color
1	White orange	—————	1	White orange
2	orange	—————	2	orange
3	White green	—————	3	White green
4	blue	—————	4	blue
5	White blue	—————	5	White blue
6	Green	—————	6	Green
7	White brown	—————	7	White brown
8	Brown	—————	8	Brown

( Fig1 )

Pin no.	Color		Pin no.	Color
1	White orange	—————	1	White green
2	orange	—————	2	Green
3	White green	—————	3	White orange
4	blue	—————	4	blue
5	White blue	—————	5	White blue
6	Green	—————	6	orange
7	White brown	—————	7	White brown
8	Brown	—————	8	Brown

( Fig 2 )

#### 4.5.4 Device address

Device address type	Range	Object type	Attribute	Modbus address
PSB	0~9999	Bit	R/W	0~9999
PSW	0.00~9999.15	Bit	R/W	0.00~9999.15
PFW	0.00~55535.15	Bit	R/W	10000.00~65535.15
PSW	0~9999	Word/Dword	R/W	0~9999
PFW	0~55535	Word/Dword	R/W	10000~65535
PSB	0~9999	Bit	R/W	0~9999

a. The internal objects of the touch screen include PSB, PSW, and PFW:

Object type	Note
PSB	Representing bit objects
PSW	Represents a non power outage hold word object
PFW	Object representing power outage hold word

b. The range of internal objects that can be used for each model:

The number and range of PSB, PSW, and PFW data can be modified through " File / System Settings / Display / Parameter Settings".

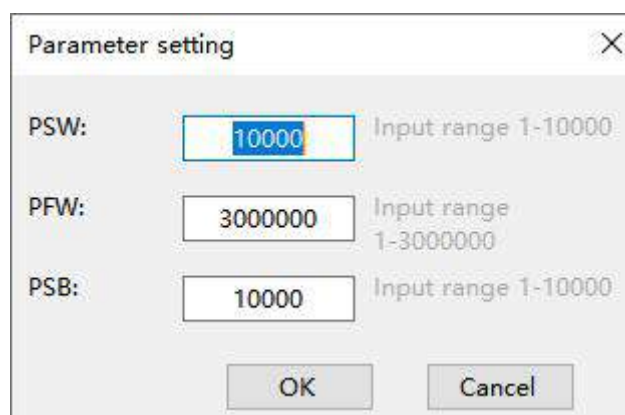

c. Special address usage inside the touch screen

SPSW, SPFW, and SPSB are used as special system functions and don't participate in communication.

# 5 Mitsubishi PLC Connection Instructions

This chapter mainly introduces the connection instructions between the touch screen and Mitsubishi PLC communication equipment.

**Note:**

**( 1 )The Xinje TS series touch screen supports a maximum baud rate of 187.5K.**

**( 2 )During communication, please don't plug or unplug cables with power, as it may cause damage to the device's serial port.**

**( 3 )Upgrade of touch screen software version, there may be some changes in the communication protocol device address range. The device address range in the software shall prevail.**

## 5.1 Mitsubishi FX series

### 5.1.1 Device type

Series	CPU	Connected module	Port	Cable making	PLC model in Touchwin software
FX	FX0 FX1 FX1S/3S FX0N/1N/2N FX3SA-14MR-CM	CPU direct connection	RS422	Fig1	Mitsubishi FX series
	FX2	CPU direct connection	RS422	Fig 2	

### 5.1.2 Parameters

1. HMI settings

Parameter	Recommend settings	Choices of settings	Note
PLC type	Mitsubishi FX series		None
Data bit	7		
Stop bit	1		
Parity	Even parity		
Baud rate	9600	4800/9600/19200	
Station No.	0		

Mitsubishi FX series protocol default communication parameters:

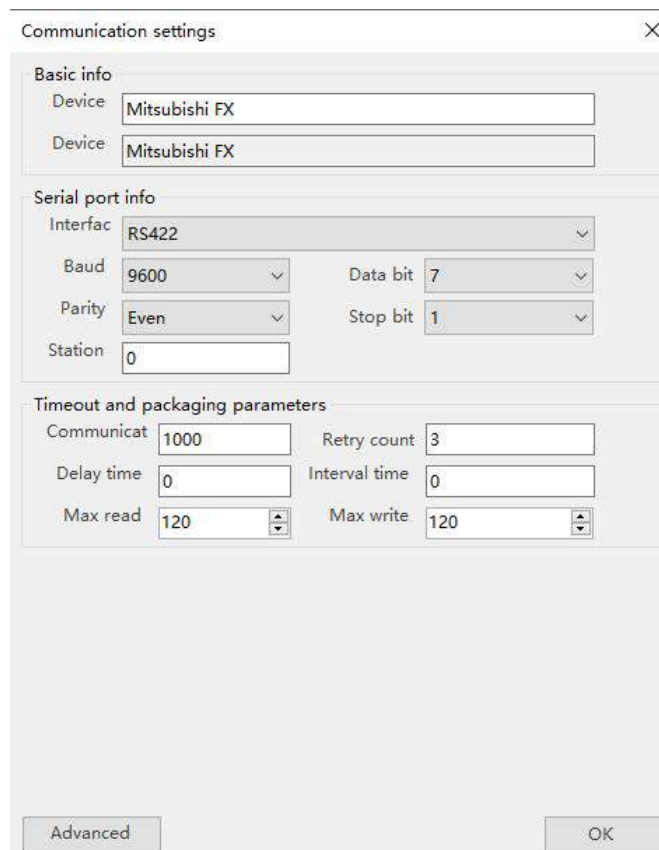

## 2. PLC settings

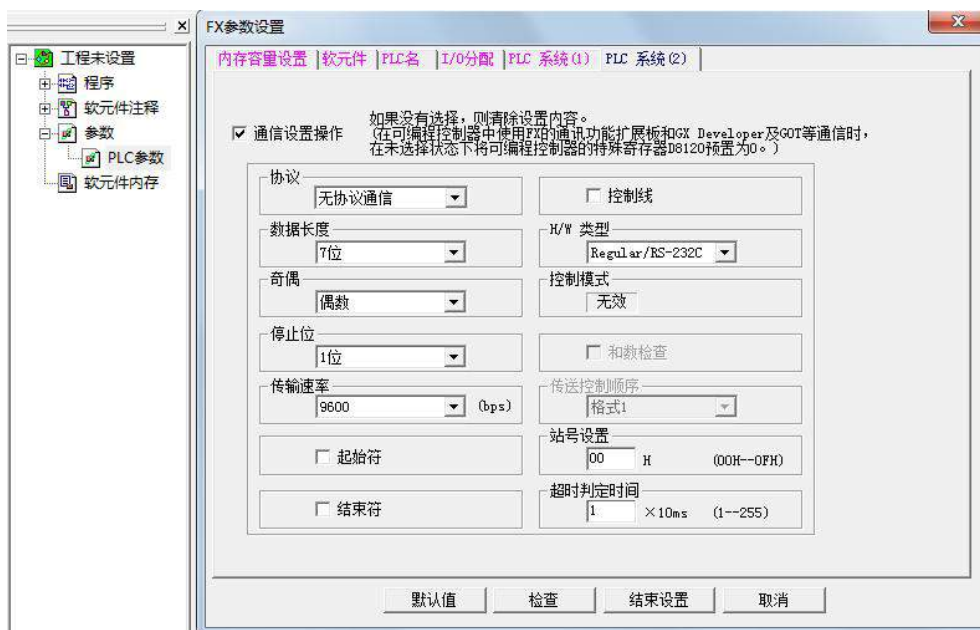

**Note: The default parity check of Mitsubishi software is "odd", but when communicating with the Xinje HMI, it's necessary to change "odd" to "even". Otherwise, even if the HMI is changed to "odd" and Mitsubishi is consistent, communication cannot be achieved. After writing the communication parameters into the PLC, it needs to be powered off and then powered on to take effect.**

### 5.1.3 Cable making

1. FX0/FX1/FX1S/FX0N/FX1N/FX2N series PLC, RS422 port:

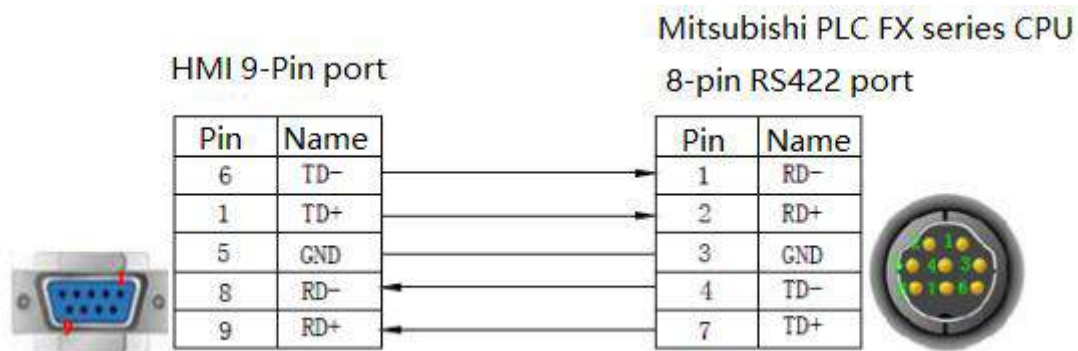

( Fig1 )

2. FX2 series PLC:

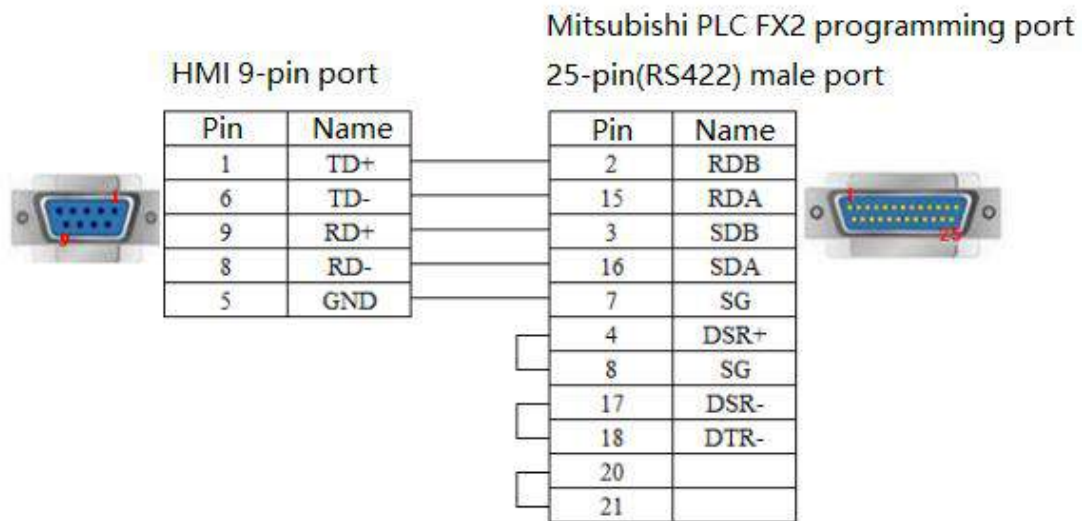

( Fig 2 )

#### 5.1.4 Device address

PLC address type	Range	Object type	Notes
X	0~177	Bit	External input coil
Y	0~177	Bit	External output coil
M	0~8255	Bit	Internal coil
S	0~999	Bit	Stepper coil
T	0~255	Bit	Timer
C	0~255	Bit	Counter
C16	0~199	Word/DWord	16-bit counter
C32	200~255	DWord	32-bit counter
D	0~8255	Word/DWord	Data register
T	0~255	Word/DWord	Current value
X	0~177	Word/DWord	Data register
Y	0~177	Word/DWord	Data register
M	0~8255	Word/DWord	Data register
S	0~999	Word/DWord	Data register

## 5.2 Mitsubishi FX3U/G series

### 5.2.1 Device type

Series	CPU	Connected module	Port	Cable making	PLC model in Touchwin software
FX	FX3U FX3G FX3GA	CPU direct connection	RS422	Fig1	Mitsubishi FX3U/G series

### 5.2.2 Parameters

#### 1. HMI settings

Parameter	Recommend settings	Choices of settings	Note
PLC type	Mitsubishi FX3U/G/GA series		None
Data bit	7		
Stop bit	1		
Parity	Even parity		
Baud rate	9600	9600	
Station No.	0		

Mitsubishi FX3U/G/GA protocol default communication parameters:

Communication settings

Basic info

Device: Mitsubishi FX3U

Device: Mitsubishi FX3U

Serial port info

Interfac: RS422

Baud: 9600 Data bit: 7

Parity: Even Stop bit: 1

Station: 0

Timeout and packaging parameters

Communicat: 1000 Retry count: 3

Delay time: 0 Interval time: 0

Max read: 120 Max write: 120

Advanced OK

## 2. PLC settings



**Note:** The default parity check of Mitsubishi software is "odd", but when communicating with the Xinje HMI, it's necessary to change "odd" to "even". Otherwise, even if the HMI is changed to "odd" and Mitsubishi is consistent, communication cannot be achieved. After writing the communication parameters into the PLC, it needs to be powered off and then powered on to take effect. When communicating with FX3U, the baud rate can only be 9600, and communication with other baud rates is not possible.

### 5.2.3 Cable making

FX3U/G/GA series PLCRS422:

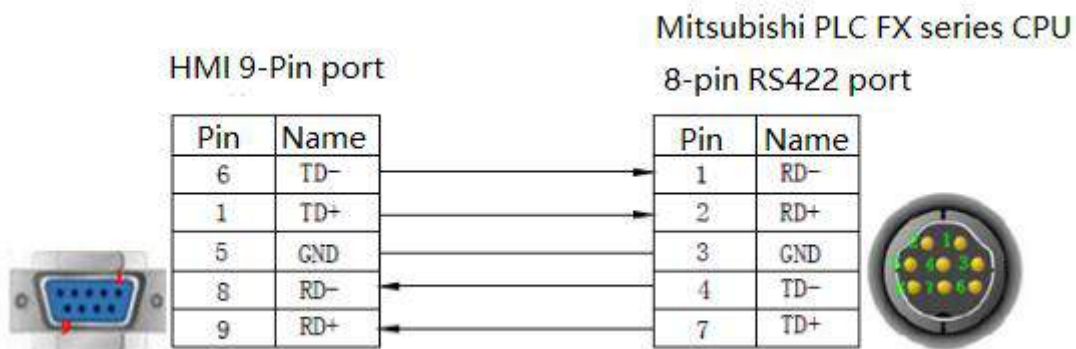

( Fig1 )

### 5.2.4 Device address

PLC address type	Range	Object type	Notes
X	0~777	Bit	External input coil
Y	0~777	Bit	External output coil
M	0~8254	Bit	Internal coil
S	0~4095	Bit	Stepper coil
T	0~511	Bit	Timer
C	0~255	Bit	Counter
SM	8000~9999	Bit	Internal special step relay
C16	0~199	Word/DWord	16-bit counter
C32	200~255	DWord	32-bit counter

---

PLC address type	Range	Object type	Notes
D	0~8254	Word/DWord	Data register
SD	8000~9999	Word/DWord	Special data register
TD	0~511	Word/DWord	Timer
R	0~32767	Word/DWord	Extended data register

## 5.3 Mitsubishi FX5U series

### 5.3.1 Device type

Series	CPU	Connected module	Port	Cable making	PLC model in Touchwin software
FX5U series	FX5U	CPU direct connection	RS485	Fig1	Mitsubishi FX5U series

### 5.3.2 Parameters

#### 1. HMI settings

Parameter	Recommend settings	Choices of settings	Note
PLC type	Mitsubishi FX5U series	Mitsubishi FX5U series / Mitsubishi Q series	When selecting the Q series, the input and output points are in decimal format
Port	RS485		
Data bit	8		
Stop bit	1		
Parity	Odd parity		
Baud rate	19200		
Station No.	0		Must use recommend settings

#### Mitsubishi FX5U series communication parameter settings

**Note:** Click on "Advanced Communication Settings" and set the local station number to "0". Please don't modify it.

#### 2. PLC settings

##### (1) MC protocol communication

**Set the protocol format to "MC protocol" and the transmission mode to "Mode 5" in the 485 serial port settings.**

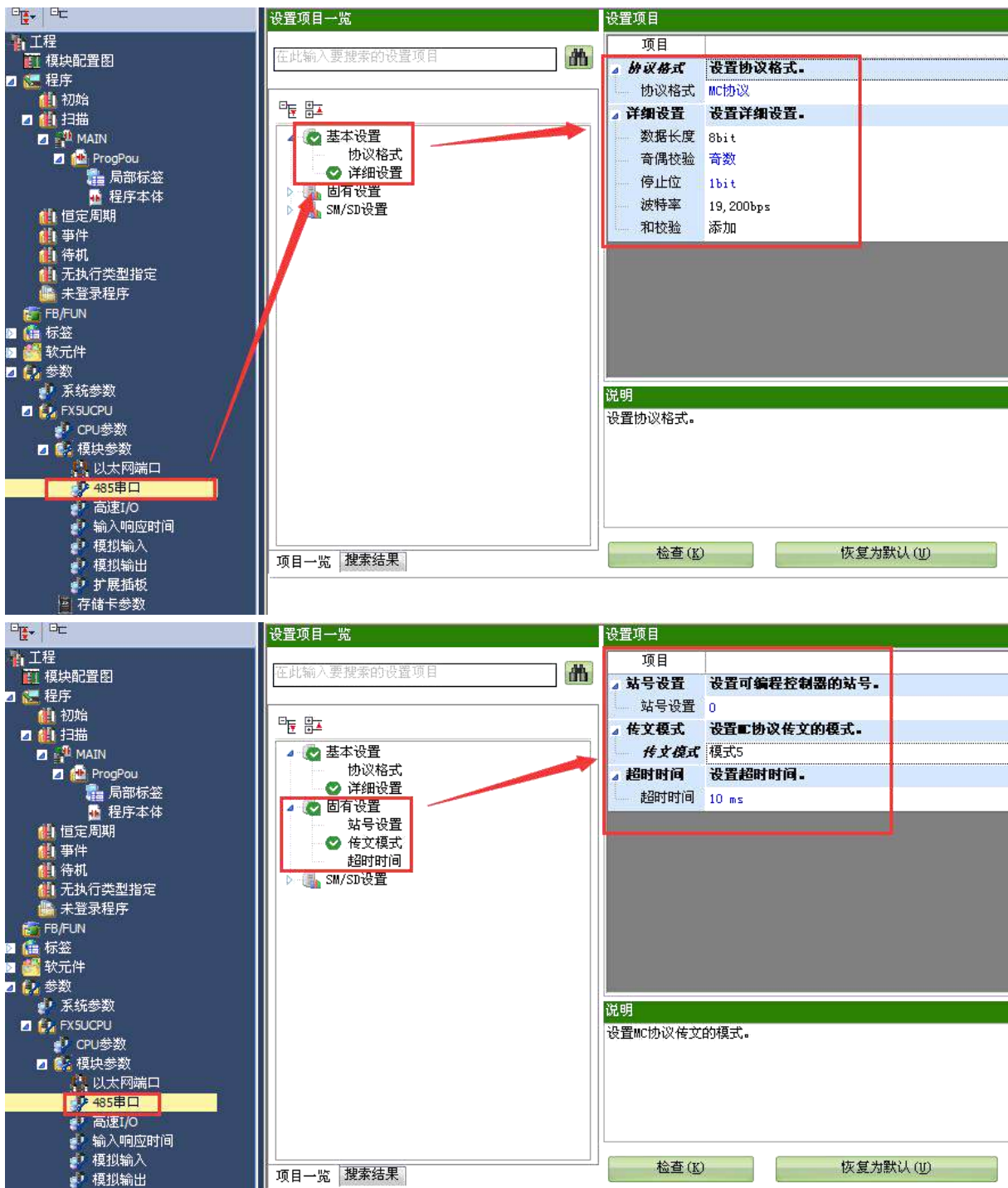

(2) Modbus RTU communication

When using this protocol, select the "Modbus RTU" protocol on the touch screen. Set the protocol format in the 485 serial port to "Modbus RTU communication". In Modbus communication, station 0 represents broadcasting, so the station number should be set to a non-zero station number. The touch screen should match the station number and communication parameters with the PLC settings.

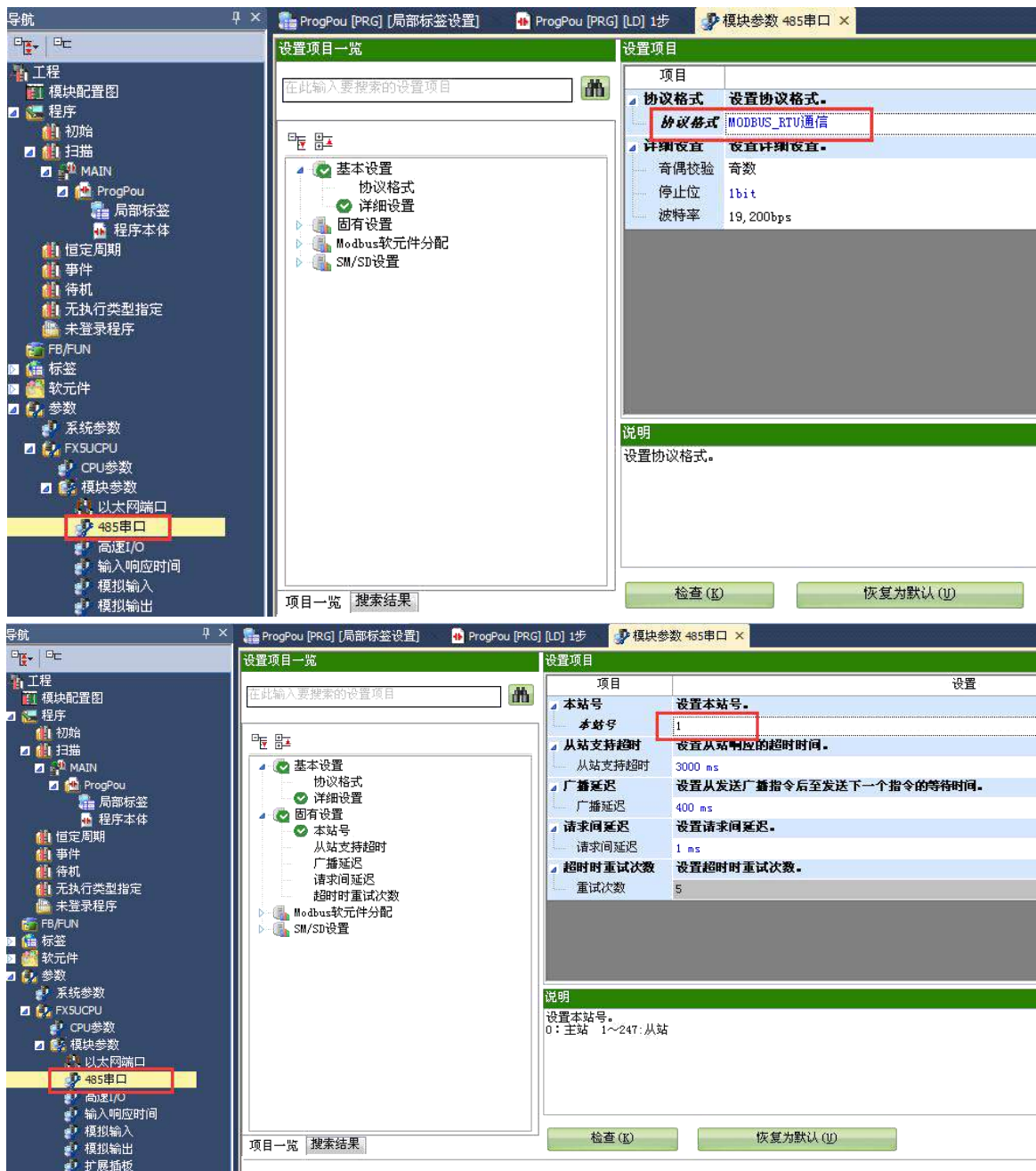

**Note:** When PLC communicates with Modbus, there is a fixed Modbus address, which is explained in the software. Read and write according to the Modbus address.



### 5.3.3 Cable making

When using the 485 port communication on the FX5U series PLC CPU unit, the cable fabrication diagram is shown below:

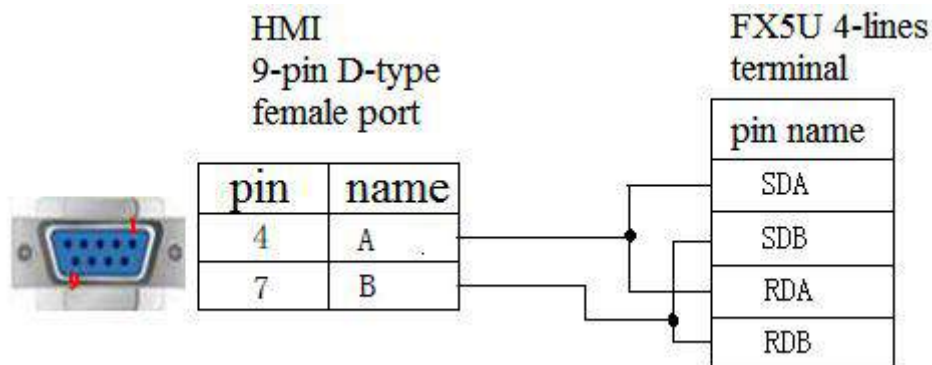

( Fig1 )

### 5.3.4 Device address

PLC address type	Range	Object type	Notes
X	0~8191	Bit	External input coil
Y	0~8191	Bit	External output coil
M	0~8191	Bit	Internal coil
B	0~8191	Bit	Linkage relay
SB	0~2047	Bit	Internal special linkage relay
DX	0~8191	Bit	Direct input
DY	0~8191	Bit	Direct output
S	0~8191	Bit	Stepper coil

SM	0~2047	Bit	Internal special step relay
L	0~8191	Bit	Locking relay
F	0~2047	Bit	Alarm
V	0~2047	Bit	Variable address relay
TS	0~2047	Bit	Timer contactor
TC	0~2047	Bit	Timer coil
SS	0~2047	Bit	Accumulated timer contactor
SC	0~2047	Bit	Accumulated timer coil
CS	0~1023	Bit	Counter contacts
CC	0~1023	Bit	Counter coil
D	0~12287	Word/DWord	Data register
W	0~8191	Word/DWord	Linkage register
SW	0~2047	Word/DWord	Internal special linkage register
ZR	0~1042431	Word/DWord	File register
SD	0~2047	Word/DWord	Internal special register
TN	0~2047	Word/DWord	Timer
SN	0~2047	Word/DWord	Accumulated timer
CN	0~1023	Word/DWord	Counter
Z	0~15	Word/DWord	Variable register
R	0~32767	Word/DWord	File register

## 5.4 Mitsubishi Q/L series

### 5.4.1 Device type

The MELSEC-Q series PLC includes CPU units such as Q00, Q01, and Q00U, which can communicate with the touch screen through the programming port or communication module (QJ71C24N) on their CPU units.

Series	CPU	Connected module	Port	Cable making	PLC model in Touchwin software
Q	Q00 Q01 Q00U Q00UJ	CPU direct connection	RS232	Fig 2	Mitsubishi Q/L series
	Q01U	CPU direct connection	RS232	Fig 2	Mitsubishi Q/L series
	Q00J Q02 Q03 Q02H Q06H Q12H Q25H Q12PH Q25PH	Communication module QJ71C24 QJ71C24N	RS232	Fig 3	Mitsubishi Q/L series
RS422	Fig 4				
L	L02CPU/L02SCPU-CM	CPU direct connection	RS422	Fig 4	Mitsubishi Q/L series
FX5U		CPU direct connection	RS485		Mitsubishi Q/L series

### 5.4.2 Parameters

#### 1. HMI settings

Parameter	Recommend settings	Choices of settings	Note
PLC type	Mitsubishi Q series		None
Data bit	8		
Stop bit	1		
Parity	Odd parity		
Baud rate	19200	9600/19200/38400/57600/115200	
Station No.	0	0~255	

Mitsubishi Q series PLC default communication parameters: 19200, 8, 1, odd, station number: 0

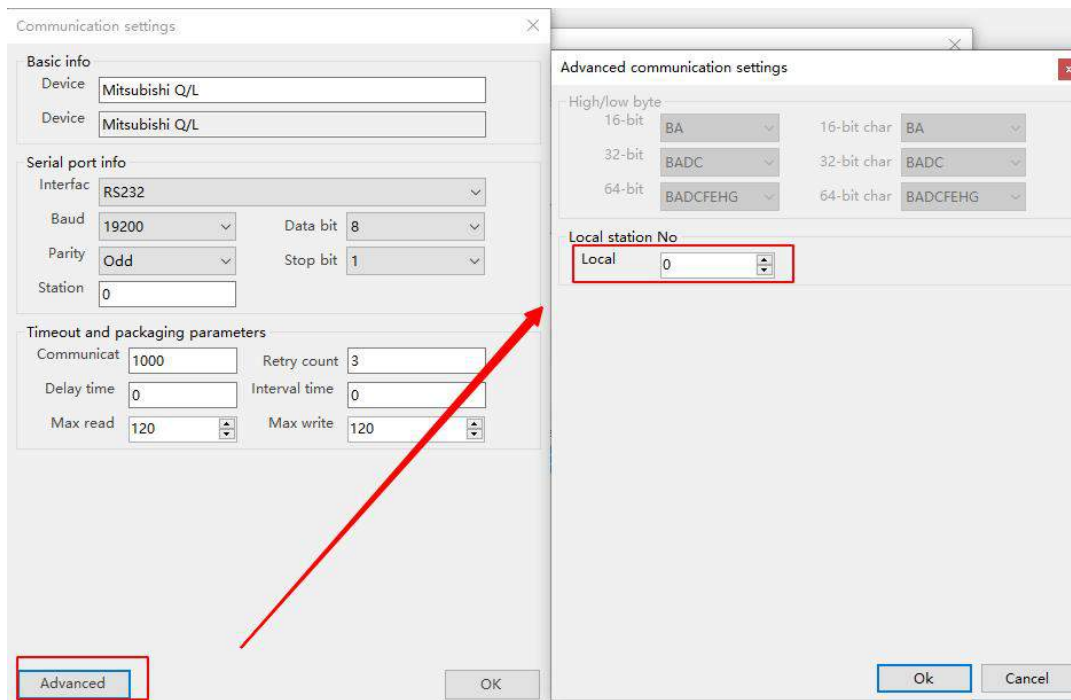

**Note:** Click on "Advanced Communication Settings" and set the local station number to "0". Please don't modify it.

## 2. PLC settings

### (1) Q01/Q00/Q00U/Q00UJ PLC Parameters

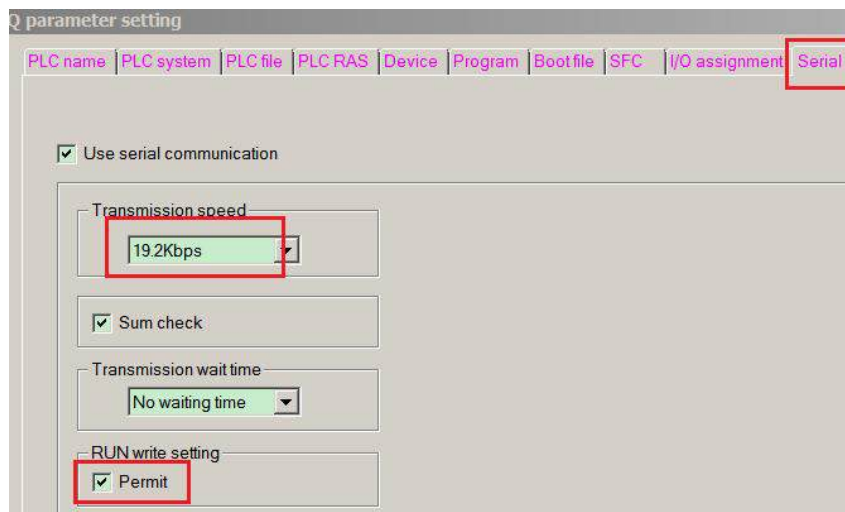

**Note:** Please make sure to set "Allow" when writing settings during operation.

### (2) Mitsubishi QJ71C24 (N) serial port module connection

The QJ71C24 (N) serial port module is used to connect the CPU ( not supporting serial communication) and communicate with other devices, such as Q02CPU. The serial port settings are as follows ( PLC software version is V8.86):

- a. Double click on "PLC Parameters" to open the following dialog box:

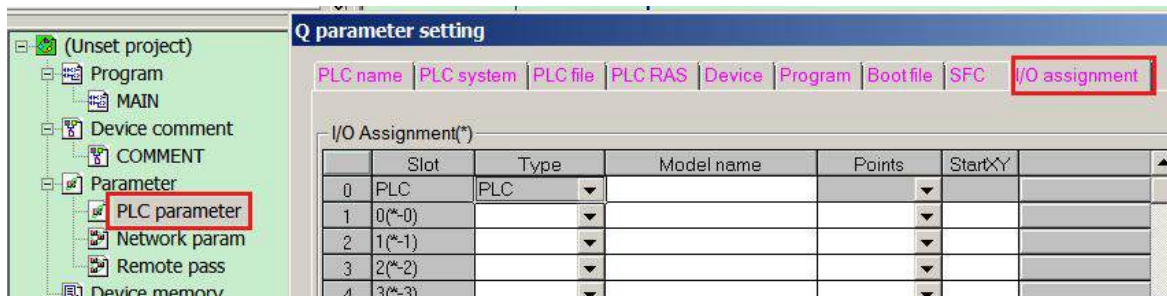

b. Select "I/O allocation" as follows:

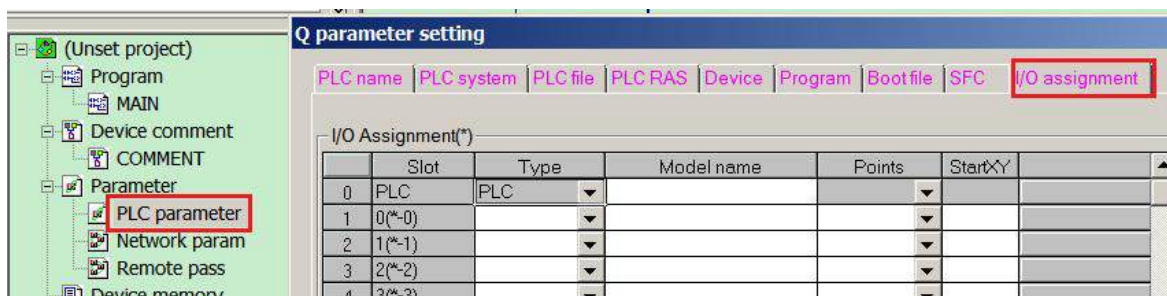

c. Set the parameter with serial number 1 in the "I/O allocation" option, and click the button to the right of "type" in serial number 1", pop up the following dialog box, set "Type" to "Intelligent", and leave everything else as default.

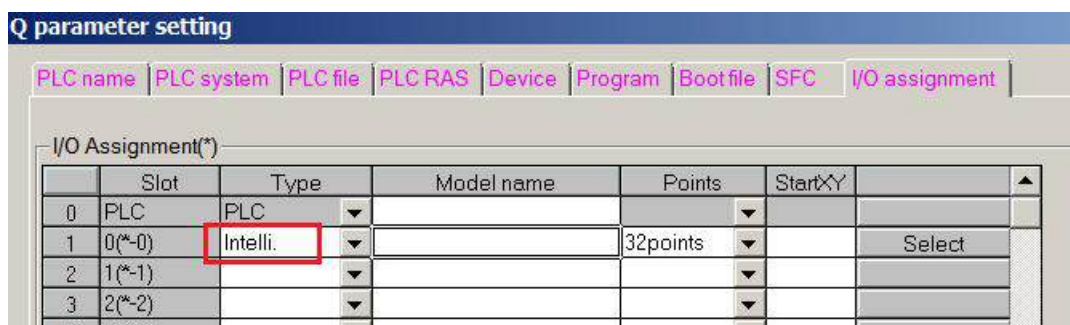

d. Click the "Switch Settings" button in the upper right corner of the "I/O Allocation" panel to open the following dialog box:

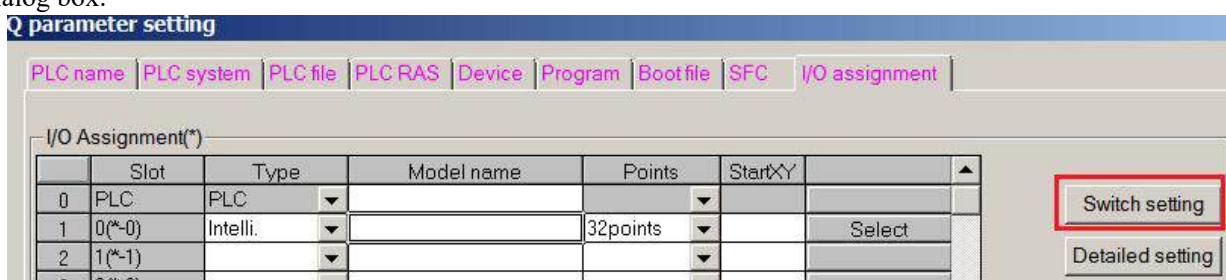

e. Set the parameter type to "Intelligent" in the line: enter "07E6" in "Switch 1", "0005" in "Switch 2", and "0000" in "Switch 5" to complete the process:

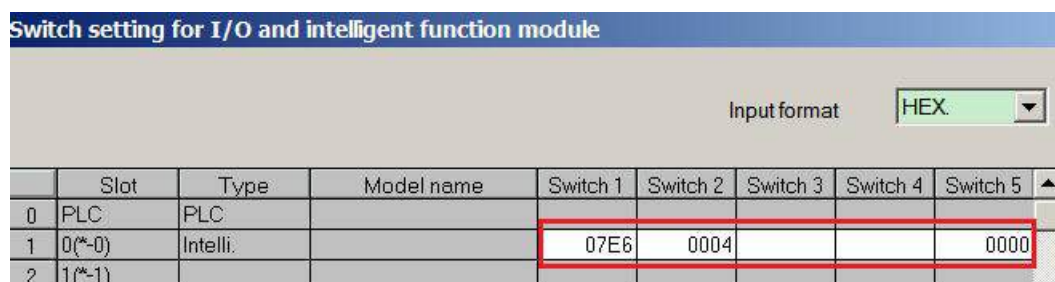

**Note:** The combination of setting values for switches 1 to 5 is 16 bit binary data, which can be used to set the transmission specifications, communication protocols, etc. of each interface:

Switch	Notes
Switch1	The communication speed and transmission settings of CH1, represented by 07E6, have a baud rate of 19200, 8 data bits, 1 stop bit, odd parity, allowing writing and setting during operation, and a sum check
Switch2	CH1 communication protocol settings, 0005 represents MC protocol format 5
Switch3	The communication speed and transmission settings of CH2 need to be set when using RS232 of QJ71C24 (N) module
Switch4	When using RS232 of QJ71C24 (N) module for CH2 communication protocol settings, this item needs to be set
Switch5	CH1 and CH2 share the same station number for MC protocol communication, with 0000 representing station number 0

Please refer to the relevant instructions for the Mitsubishi Q series serial communication module for details.

f. Click the "End Settings" button to download the set parameters to the PLC, then power off the PLC and restart it. The parameter settings are complete.

The PLC software is set as follows, and **the communication protocol is set to MC protocol (Form 5):**

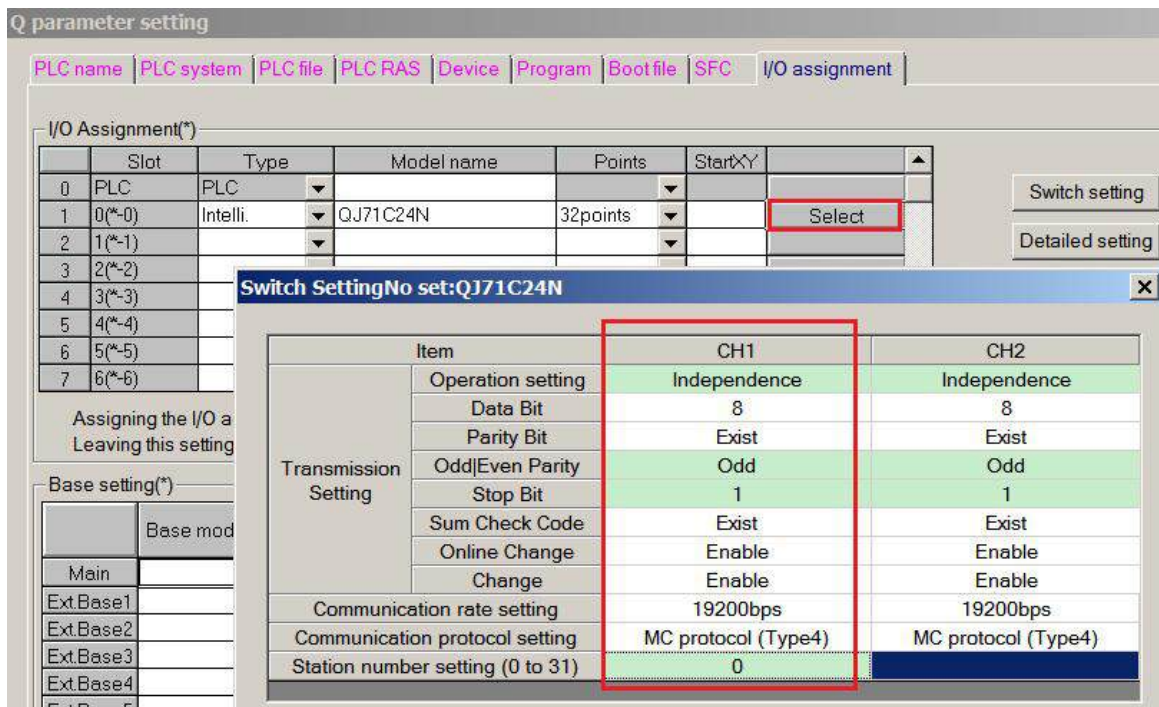

**Note:** When using the RS232 of QJ71C24 (N) module, the PLC needs to set the parameters of switch 3, switch 4, and CH2.

### 5.4.3 Cable making

1. When using the RS232 communication port on the Q series PLC CPU unit, the cable fabrication diagram is shown below:

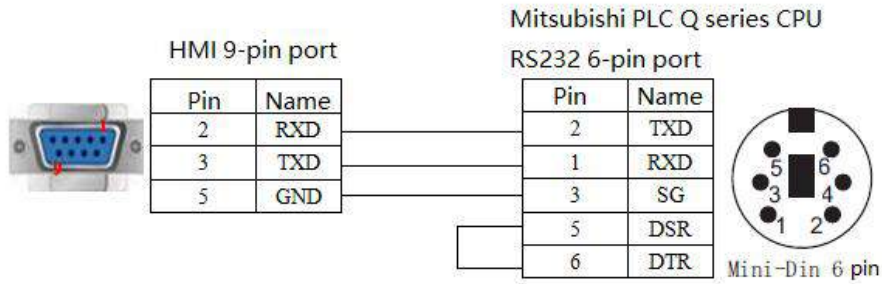

( Fig1 )

2. When the Q series PLC uses the RS232 of the QJ71C24 (N) module, the cable fabrication diagram is shown below:

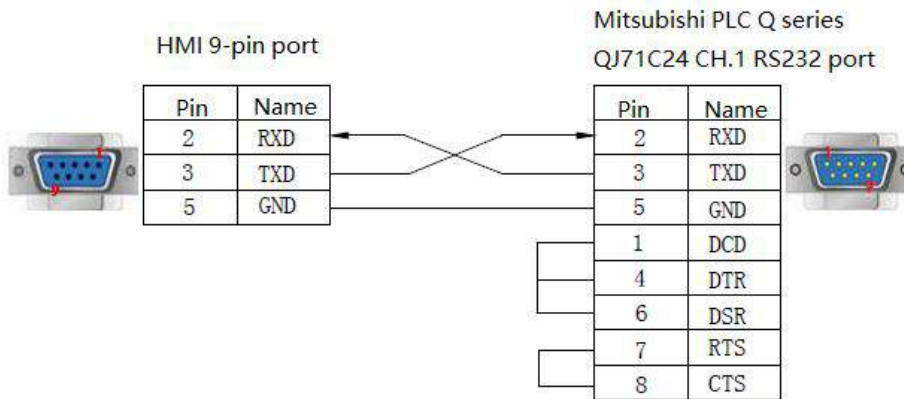

( Fig 3 )

3. When the Q series PLC uses the RS422 of the QJ71C24 (N) module, the cable making diagram is shown below:

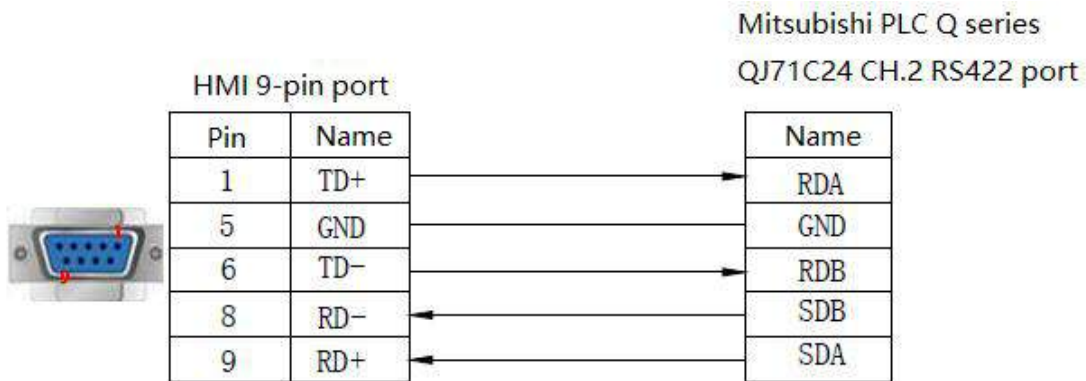

( Fig 4 )

#### 5.4.4 Device address

PLC address type	Range	Object type	Notes
X	0~8191	Bit	External input coil
Y	0~8191	Bit	External output coil
M	0~8191	Bit	Internal coil
B	0~8191	Bit	Linkage relay
SB	0~2047	Bit	Internal special linkage relay
DX	0~8191	Bit	Direct input
DY	0~8191	Bit	Direct output

PLC address type	Range	Object type	Notes
S	0~8191	Bit	Stepper coil
SM	0~2047	Bit	Internal special step relay
L	0~8191	Bit	Locking relay
F	0~2047	Bit	Alarm
V	0~2047	Bit	Variable address relay
TS	0~2047	Bit	Timer contactor
TC	0~2047	Bit	Timer coil
SS	0~2047	Bit	Accumulated timer contactor
SC	0~2047	Bit	Accumulated timer coil
CS	0~1023	Bit	Counter contacts
CC	0~1023	Bit	Counter coil
D	0~12287	Word/DWord	Data register
W	0~8191	Word/DWord	Linkage register
SW	0~2047	Word/DWord	Internal special linkage register
ZR	0~1042431	Word/DWord	File register
SD	0~2047	Word/DWord	Internal special register
TN	0~2047	Word/DWord	Timer
SN	0~2047	Word/DWord	Accumulated timer
CN	0~1023	Word/DWord	Counter
Z	0~15	Word/DWord	Variable register
R	0~32767	Word/DWord	File register

## 5.5 Mitsubishi Q02H series

### 5.5.1 Device type

Series	CPU	Connected module	Port	Cable making	PLC model in Touchwin software
Q	Q02 Q02H	CPU direct connection	RS232	Fig1	Mitsubishi Q02H series
L	L02 L06CPU-CM	LJ71C24-CM	RS232	Fig 2	Mitsubishi Q02H series
			RS422	Fig 3	

### 5.5.2 Parameters

#### 1. HMI settings

Parameter	Recommend settings	Choices of settings	Note
PLC type	Mitsubishi Q02H series		None
Data bit	8		
Stop bit	1		
Parity	Odd parity		
Baud rate	115200	9600/19200/38400/57600/115200	
Station No.	0	0~255	

Mitsubishi Q02 series PLC default communication parameters: 115200, 8, 1, odd, station number: 0

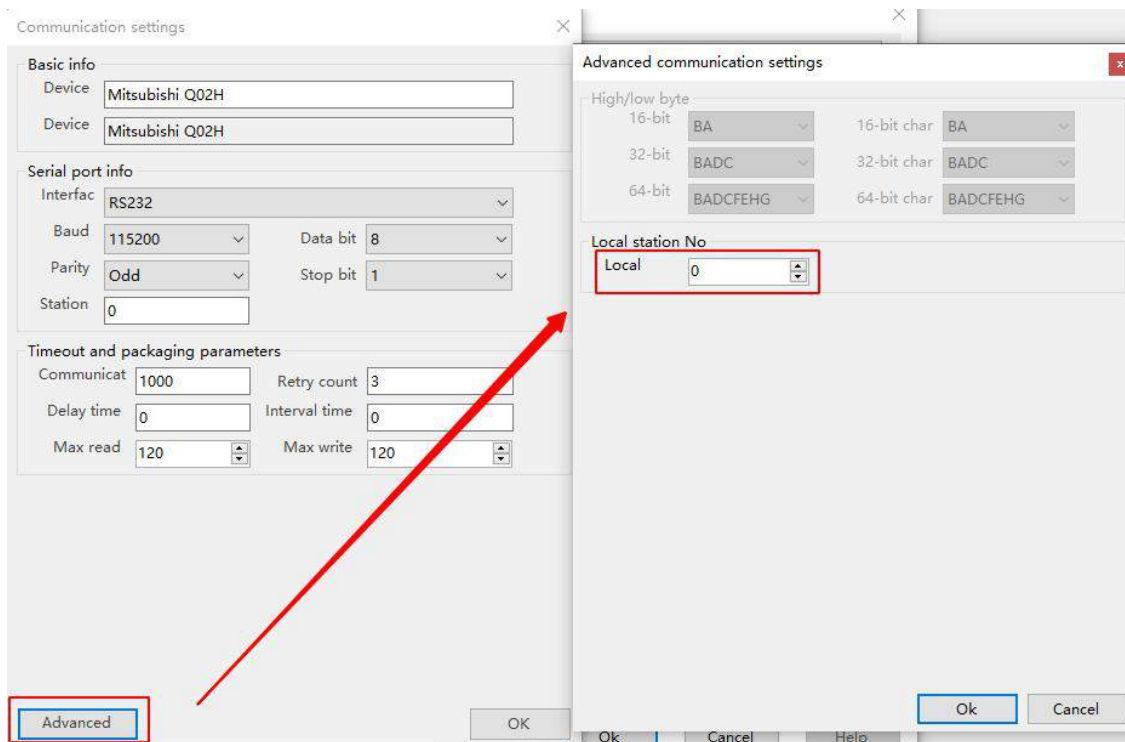

**Note:** Click on "Advanced Communication Settings" and set the local station number to "0". Please don't modify it.

#### 2. PLC settings

- (1) **Mitsubishi Q02 series** PLC default communication parameters: 115200, 8, 1, odd, station number: 0, don't need to be modified.
- (2) **L series LJ71C24 module** communication, serial port settings are as follows (PLC software version is GX Works 2 Version 1.555D):

HMI parameters:

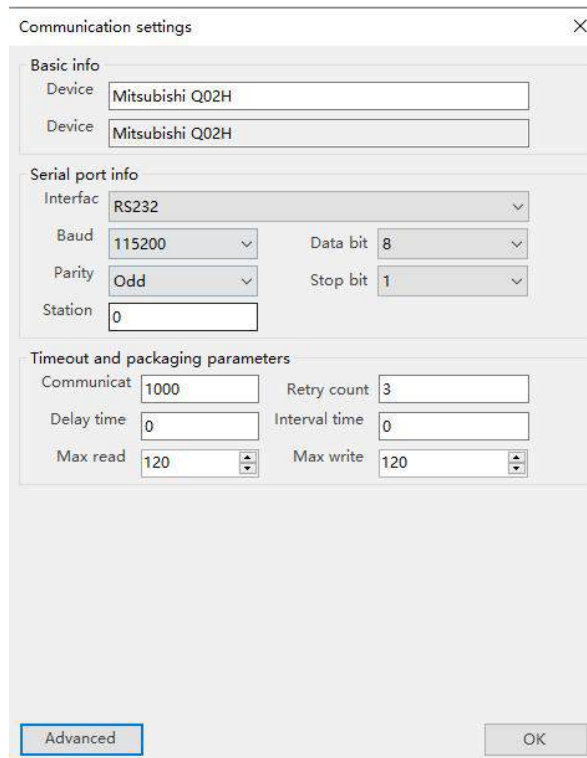

Add module information to PLC software:

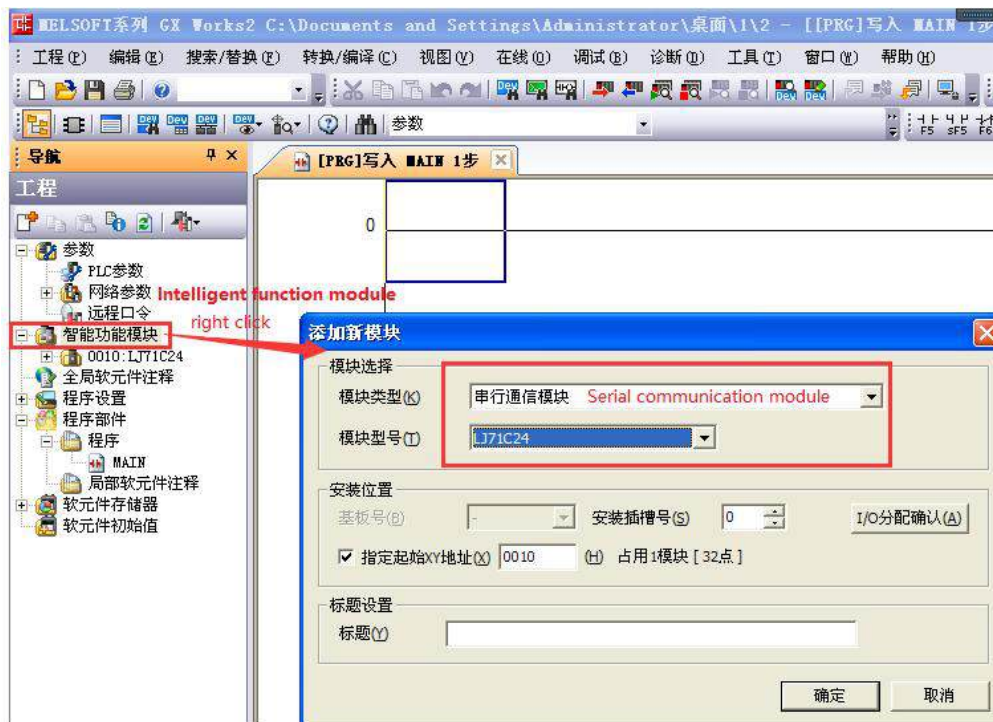

There are two methods to configure module parameters: configuring in module parameters and configuring in PLC parameters. **The two are interrelated**, for example, if a parameter is modified in the module parameter, the corresponding parameter in the PLC parameter will be automatically modified accordingly.

Method 1: Configure in the module parameters as follows:

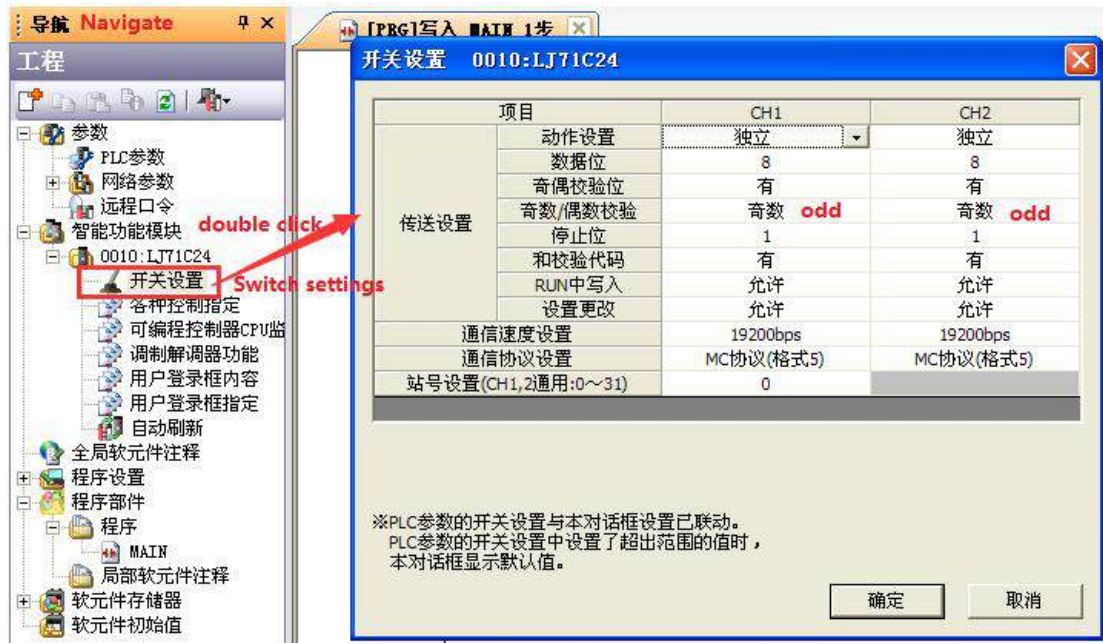

Note: CH1 is the 232 channel of LJ71C24-CM module, and CH2 is the 422 channel of LJ71C24-CM module.

Method 2: Configure in PLC parameters.

- a. Double click on the PLC parameters and the following window will pop up. Select "I/O Allocation Settings", and the information of the added modules will be displayed in the interface, as follows:

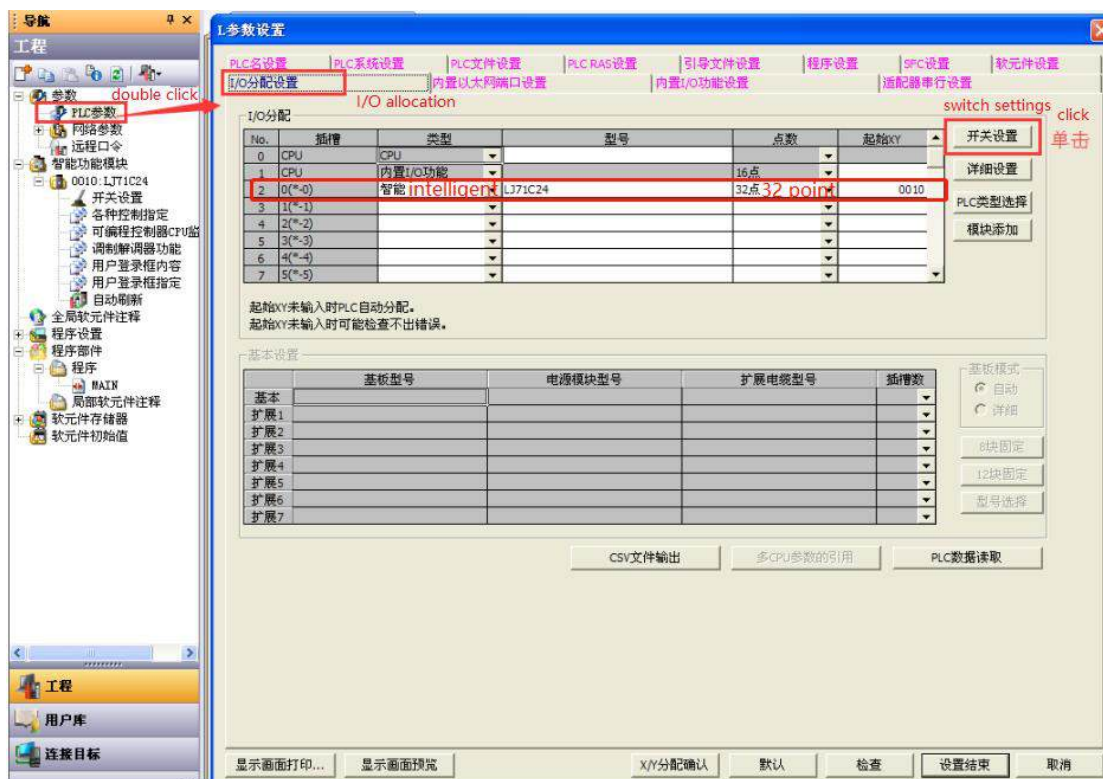

- b. Click the "Switch Settings" button in the upper right corner of the "I/O Allocation" panel to open the following dialog box:



Set the type to "Intelligent" as the line parameter:

The combination of setting values for switches 1 to 5 is 16 bit binary data, which can be used to set the transmission specifications, communication protocols, etc. of each interface:

Switch	Notes
Switch 1	The communication speed and transmission settings of CH1, represented by 07E6, have a baud rate of 19200, 8 data bits, 1 stop bit, odd parity, allowing writing and setting during operation, and a sum check
Switch 2	CH1 communication protocol settings, 0005 represents MC protocol format 5
Switch 3	The communication speed and transmission settings of CH2 need to be set when using RS422 of LJ71C24 module
Switch 4	When using RS422 of LJ71C24 module for CH2 communication protocol settings, this item needs to be set
Switch 5	CH1 and CH2 share the same station number for MC protocol communication, with 0000 representing station number 0

Please refer to the relevant instructions for the Mitsubishi L series serial communication module for details.

**Note: CH1 is the 232 channel of LJ71C24-CM module, and CH2 is the 422 channel of LJ71C24-CM module.**

For example, if using the CH1 channel for RS232 communication, enter "07E6" in "Switch 1", "0005" in "Switch 2", and "0000" in "Switch 5". If using the CH2 channel for RS422 communication, input "07E6" in "Switch 3", "0005" in "Switch 4", and "0000" in "Switch 5".

- c. Click the "Settings End" button to download the set parameters to the PLC, and then power on the PLC again to complete the parameter settings.

### 5.5.3 Cable making

1. When using the RS232 communication port on the Q series PLC CPU unit, the cable fabrication diagram is shown below:

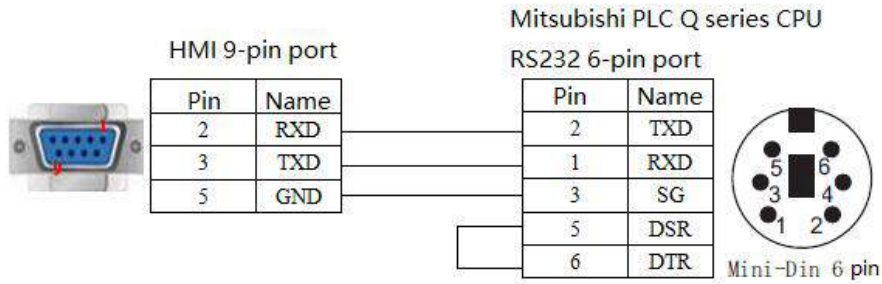

( Fig1 )

2. When the L-series PLC uses the RS232 of the LJ71C24 module, the cable fabrication diagram is shown below:

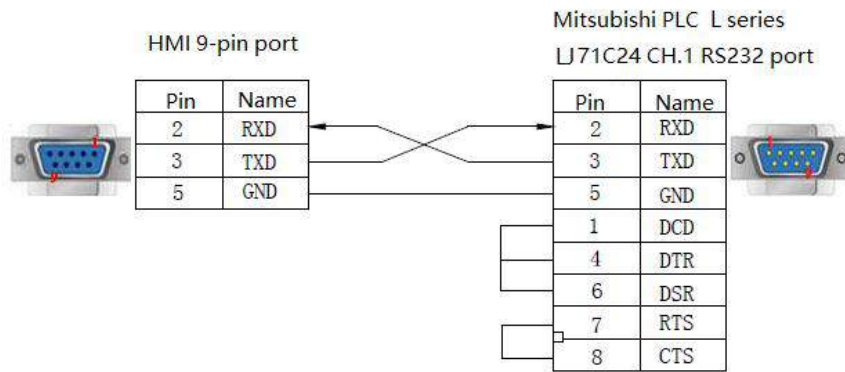

( Fig 2 )

3. When using the RS422 of the LJ71C24 module in the L-series PLC, the cable making diagram is shown below:

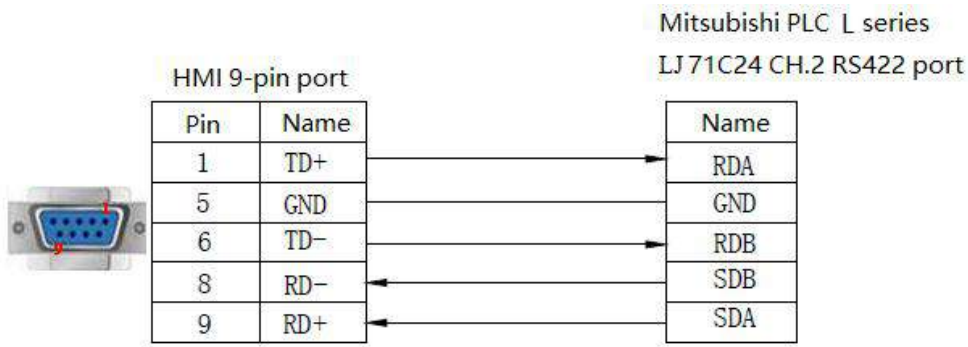

( Fig 3 )

#### 5.5.4 Device address

PLC address type	Range	Object type	Notes
X	0~8191	Bit	External input coil
Y	0~8191	Bit	External output coil
M	0~8191	Bit	Internal coil
B	0~8191	Bit	Linkage relay
SB	0~2047	Bit	Internal special linkage relay
DX	0~8191	Bit	Direct input
DY	0~8191	Bit	Direct output
S	0~8191	Bit	Stepper coil
SM	0~2047	Bit	Internal special step relay

PLC address type	Range	Object type	Notes
L	0~8191	Bit	Locking relay
F	0~2047	Bit	Alarm
V	0~2047	Bit	Variable address relay
TS	0~2047	Bit	Timer contactor
TC	0~2047	Bit	Timer coil
SS	0~2047	Bit	Accumulated timer contactor
SC	0~2047	Bit	Accumulated timer coil
CS	0~1023	Bit	Counter contacts
CC	0~1023	Bit	Counter coil
D	0~12287	Word/DWord	Data register
W	0~8191	Word/DWord	Linkage register
SW	0~2047	Word/DWord	Internal special linkage register
ZR	0~1042431	Word/DWord	File register
SD	0~2047	Word/DWord	Internal special register
TN	0~2047	Word/DWord	Timer
SN	0~2047	Word/DWord	Accumulated timer
CN	0~1023	Word/DWord	Counter
Z	0~15	Word/DWord	Variable register
R	0~32767	Word/DWord	File register

## 5.6 Mitsubishi Q/L series Ethernet

### 5.6.1 Device type

Series	Port	Cable making	PLC model in Touchwin software
Mitsubishi L series Mitsubishi Q series	RJ45	Fig 1 or Fig 2	Mitsubishi Q/L series Ethernet

### 5.6.2 Parameters

Taking Mitsubishi L series PLC as an example, explain the communication settings of Mitsubishi Q/L series Ethernet devices.

#### 1. PLC settings

- (1) Open the engineering area parameters PLC parameters built-in Ethernet port setting interface, set the PLC IP address, set the communication data code to "binary code communication", check "Write in Run (FTP and MC protocol)", as shown in the following figure:

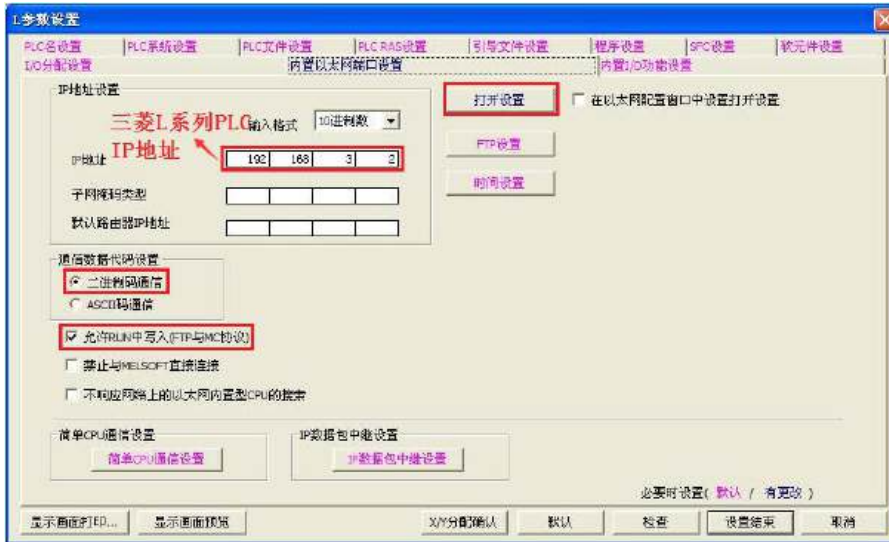

- (2) Select "Open Settings", click the left mouse button, and the following window will open. Select "TCP" as the protocol, select "MC Protocol" as the opening method, and set the local port number (setting range: 0401H~1387H, 1392H~FFFEH):



Note: In the network parameter settings of the L-series network module, the initial time setting needs to be checked as always OPEN waiting.

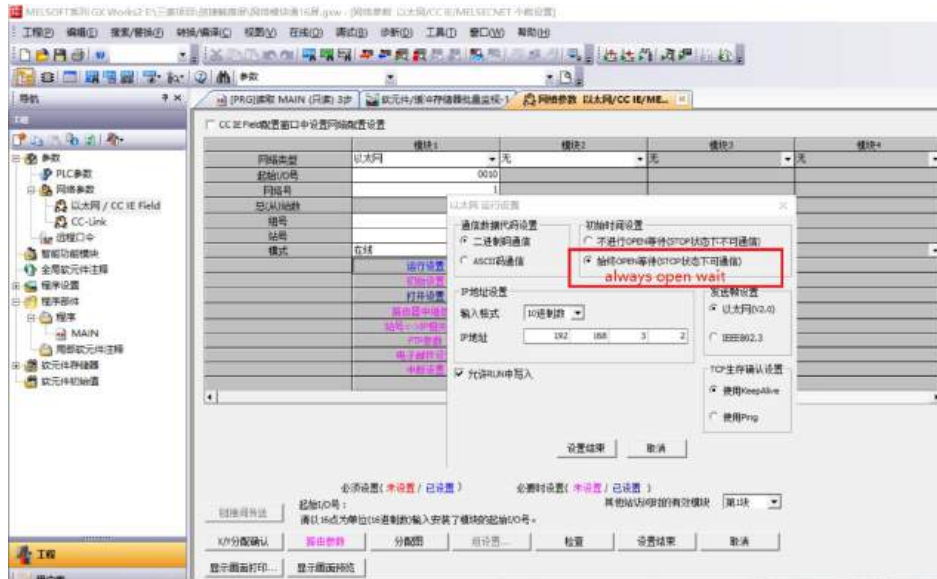

## 2. HMI settings

- (1) After selecting the human-machine interface model as - E, click to proceed to the next step, select "Net1" in the device list, and set the IP address used for the human-machine interface in "Set Local IP", as long as it doesn't conflict with other IPs in the network.

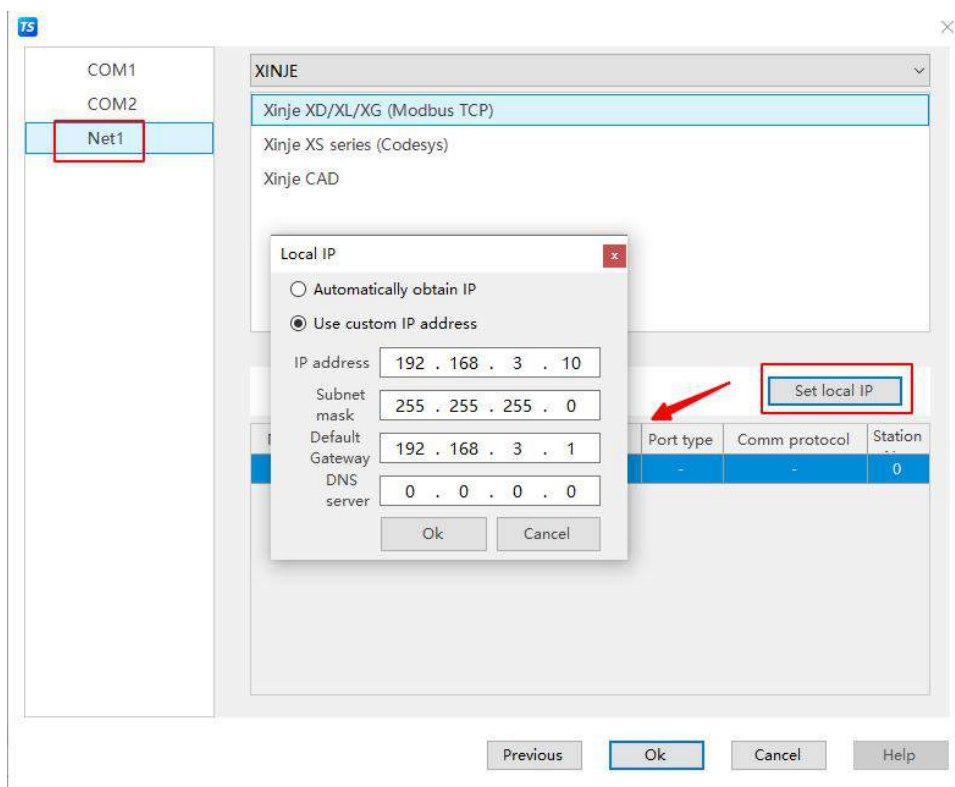

- (2) Select "Net1", click the drop-down button, and select "Mitsubishi" from the brand list:

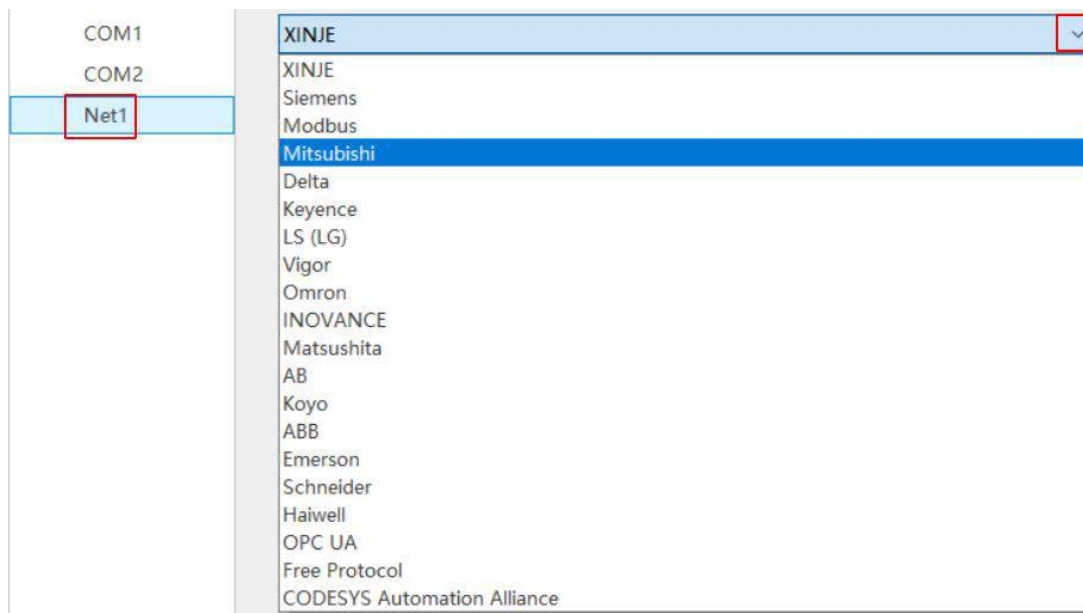

- (3) Click on "Mitsubishi Q/L Series Ethernet" in the model list, then select "New Device", and set communication parameters in the pop-up communication settings window. This IP address is the IP address of Mitsubishi Q/L series PLC (which can be set through PLC software), and the port number is the "Local Port Number" (decimal) set in the PLC software. After setting up, click "Confirm".

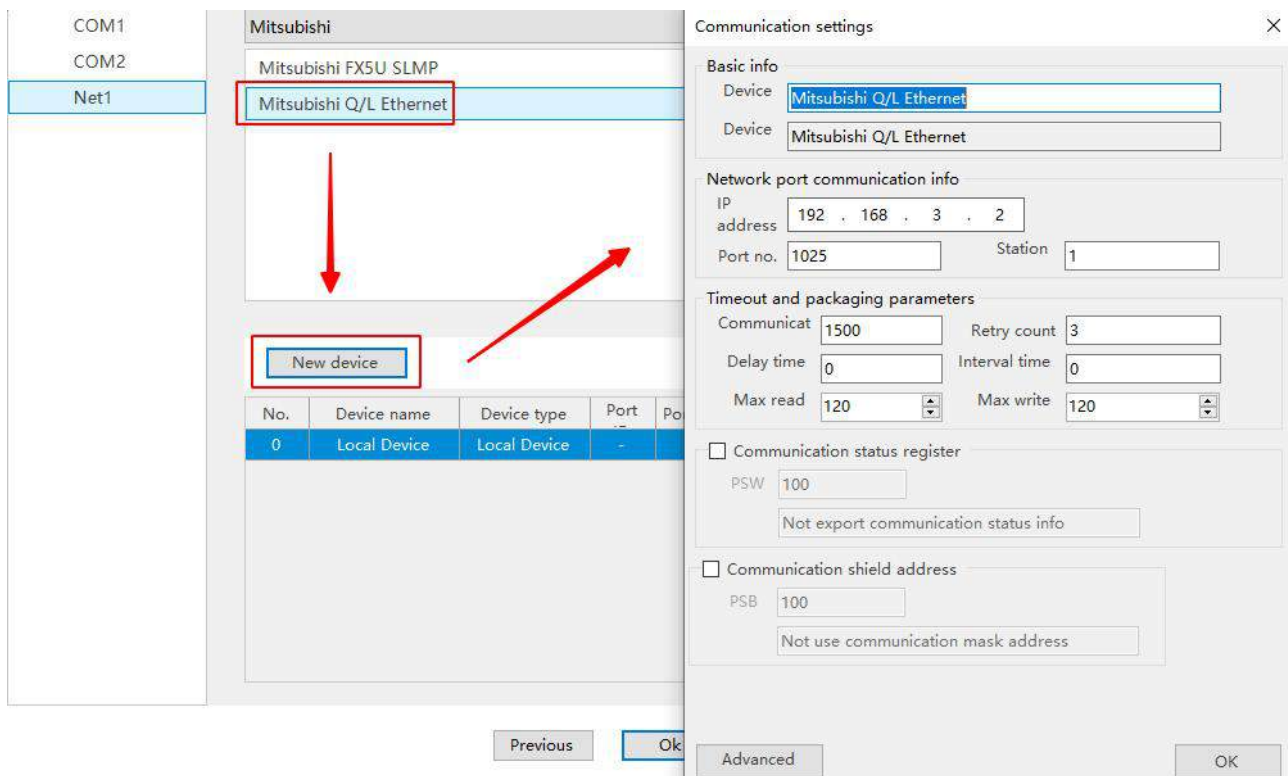

- (4) Check the "Communication Status Register", set PSW to 100, and select PSW100~PSW103 as the communication success number, communication failure number, communication timeout number, and communication error number. Customers can set this communication status address themselves.



- (5) After setting up, click "OK" to end the setup and enter the screen editing interface. Place a data External input coil component on the screen and select it from the device drop-down bar, select the corresponding device "Mitsubishi Q/L Ethernet":



### 5.6.3 Cable making

RJ45 Straight Through Cable (connected to HUB) or RJ45 Crossover Cable :

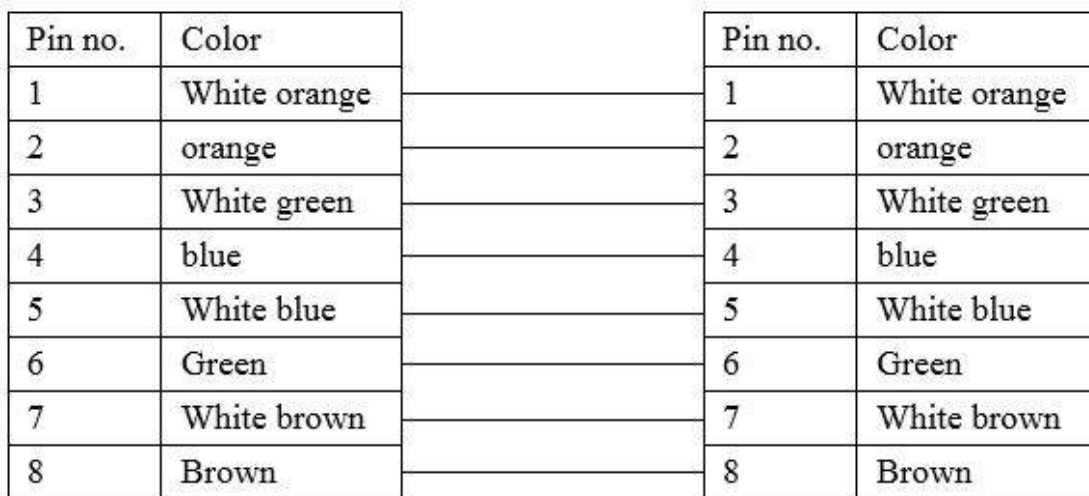

### 5.6.4 Device address

PLC address type	Range	Object type	Notes
X	0~1fff	Bit	External input coil
Y	0~1fff	Bit	External output coil
M	0~8191	Bit	Internal coil

PLC address type	Range	Object type	Notes
L	0~8191	Bit	Locking relay
F	0~2047	Bit	Alarm
V	0~2047	Bit	Variable address relay
B	0~1fff	Bit	Linkage relay
TS	0~2047	Bit	Timer contacts
SS	0~2047	Bit	Holding delay timer relay
CS	0~1023	Bit	Counter contacts
SB	0~7ff	Bit	Special link relay
S	0~2047	Bit	Stepper coil
SM	0~2047	Bit	Special relay
D	0~65535	Word/DWord	Data register
W	0~1fff	Word/DWord	Linkage register
TC	0~2047	Word/DWord	Timer coil
TN	0~2047	Word/DWord	Current value
SC	0~2047	Word/DWord	Holding delay timer coil
SN	0~2047	Word/DWord	Holding delay timer present value
CC	0~1023	Word/DWord	Counter coil
CN	0~1023	Word/DWord	Counter current value
SW	0~7ff	Word/DWord	Special link register
SD	0~2047	Word/DWord	Special register
Z	0~19	Word/DWord	Variable register

## 5.7 Mitsubishi FX5U series (SLMP)

### 5.7.1 Device type

Series	Port	Cable making	PLC model in Touchwin software
Mitsubishi FX5U series	RJ45	Fig 1 or Fig 2	Mitsubishi FX5U series (SLMP)

### 5.7.2 Parameters

Taking Mitsubishi FX5U series PLC as an example, explain the communication settings of Mitsubishi FX5U series (SLMP) protocol equipment.

#### 1. PLC settings

- (1) Click on: Navigation - Parameters - FX5UPLC - Module Parameters - Ethernet Port, set the IP address and gateway of the PLC. In this example, set the IP address of the PLC to 192.168.1.251.

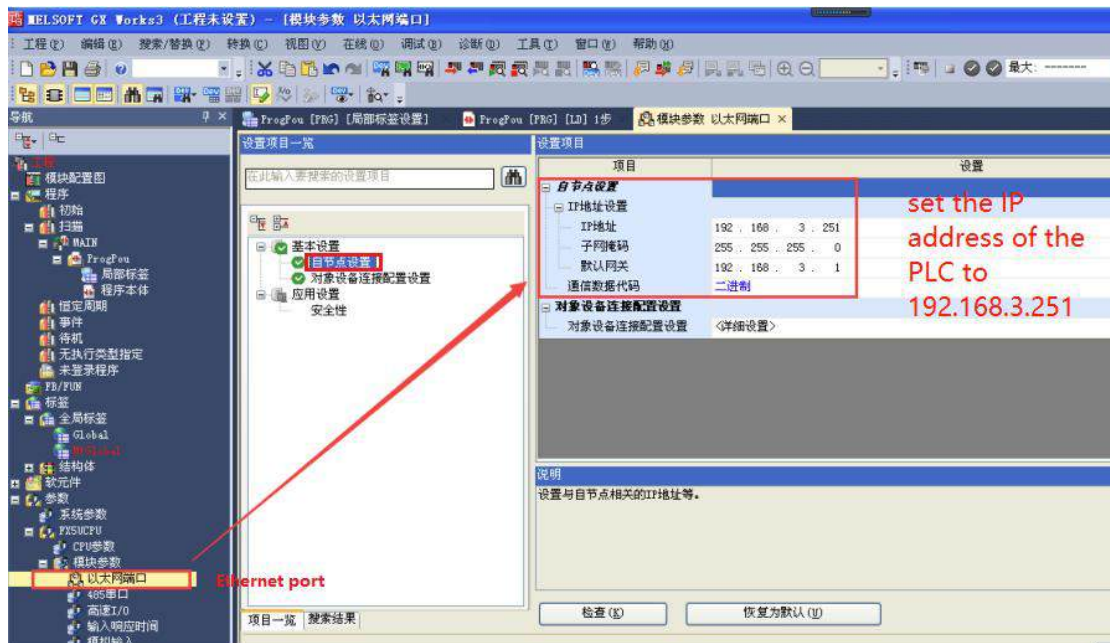

- (2) Click on detailed settings, select Ethernet device (universal) - SLMP connection device in the right window, drag and drop it directly to the network configuration interface. The IP address is the address of each PLC, and the default port number is 4999. After completion, save and download to the PLC. Check the PLC parameter item when downloading.



## 2. HMI settings

- (1) After selecting the human-machine interface model as - E, click to proceed to the next step, select "Net1" in the device list, and set the IP address used for the human-machine interface in "Set Local IP", as long as it doesn't conflict with other IPs in the network.

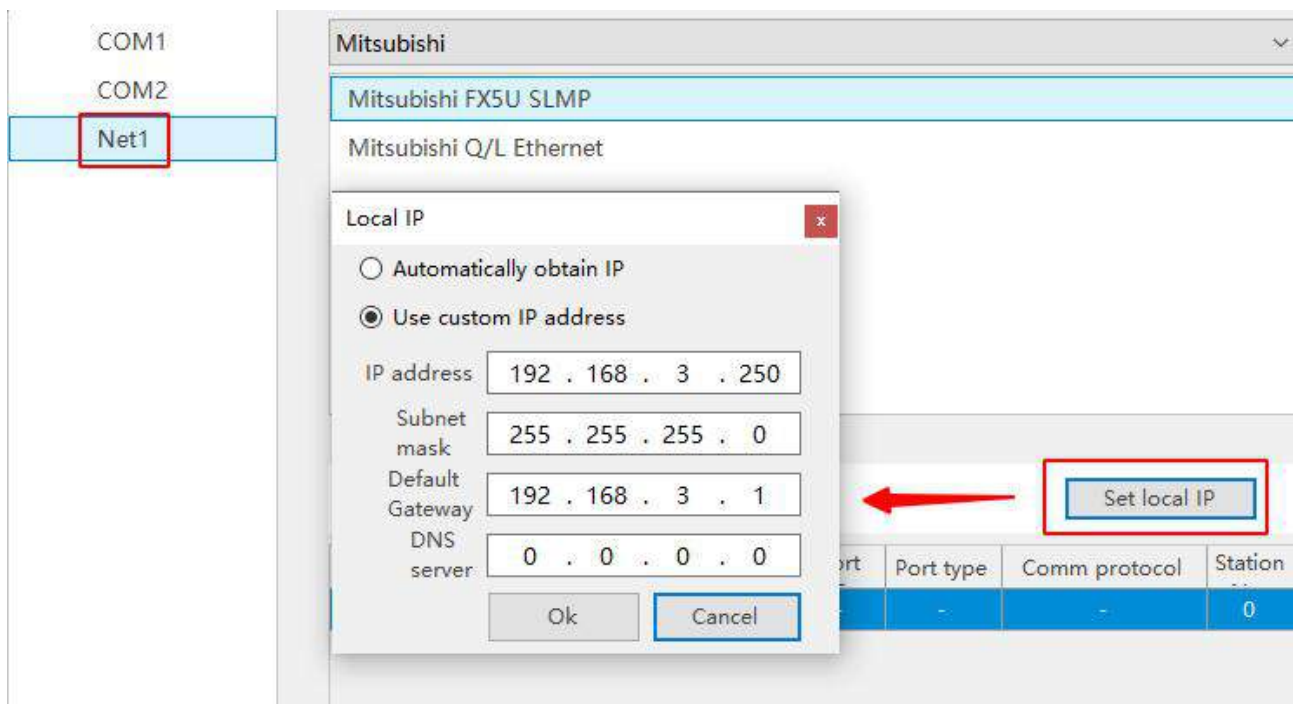

- (2) Select "Net1", click the drop-down button, and select "Mitsubishi" from the brand list:

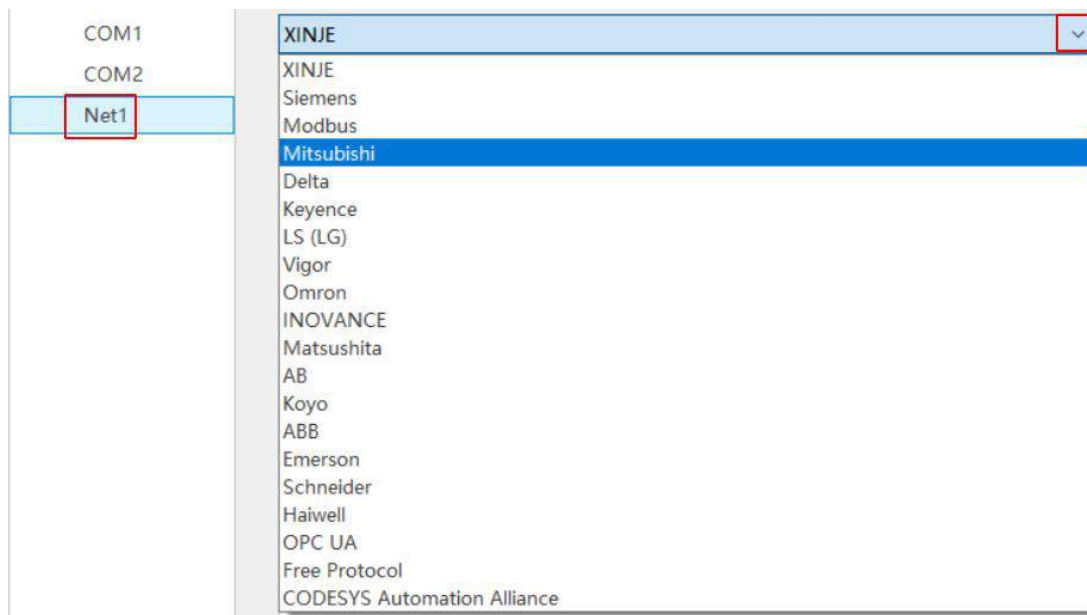

- (3) Click on "Mitsubishi FX5U Series (SLMP)" in the model list, then select "New Device" and set communication parameters in the pop-up communication settings window. This IP address is the IP address of Mitsubishi FX5U series PLC (which can be set through PLC software), and the port number is the "Local Port Number" (decimal) set in the PLC software. After setting up, click "Confirm".

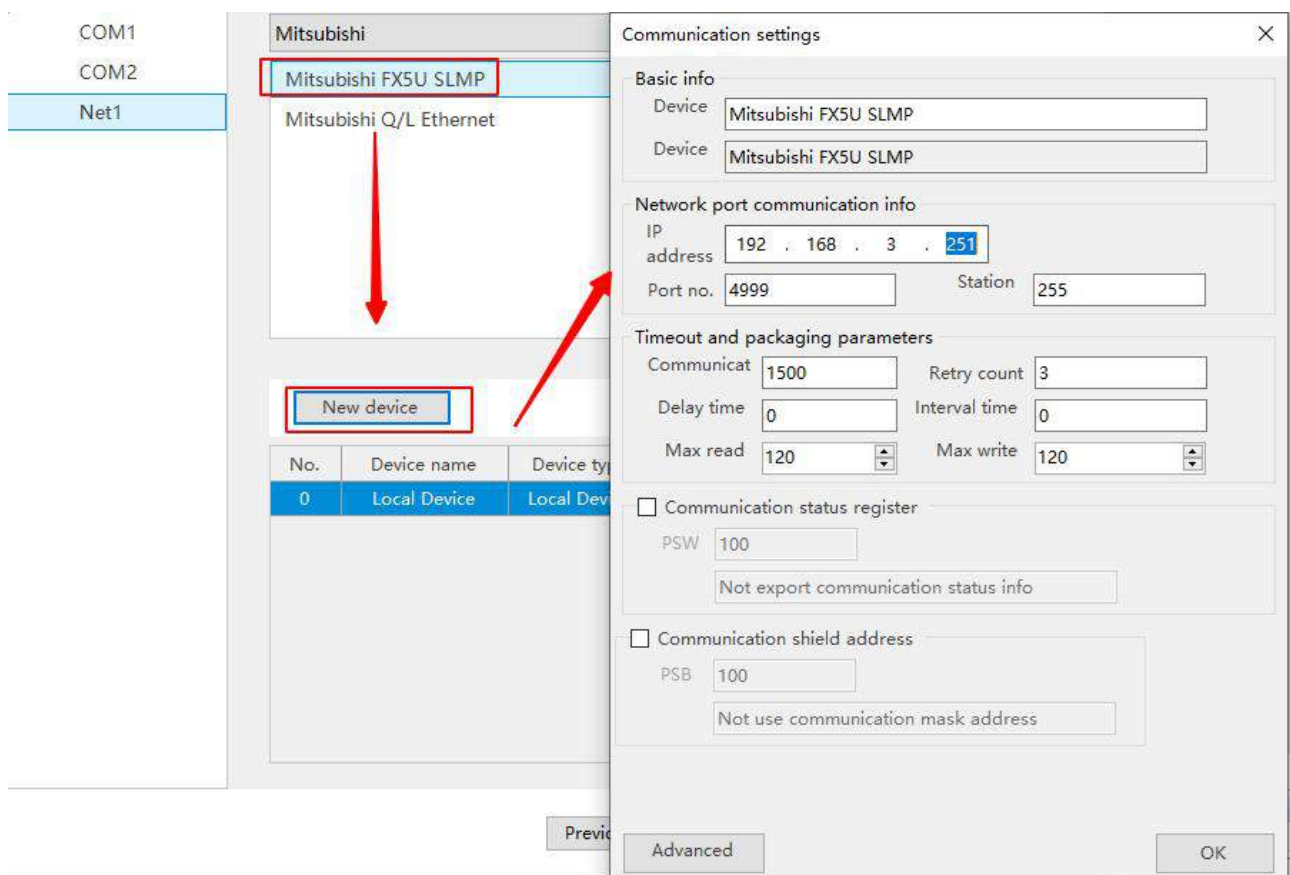

- (4) Check the "Communication Status Register", set PSW to 100, and select PSW100~PSW103 as the communication success number, communication failure number, communication timeout number, and communication error number. Customers can set this communication status address themselves.

Communication status register

PSW

- (5) After setting up, click "OK" to end the setup and enter the screen editing interface. Place a data External input coil component on the screen and select it from the device drop-down bar, Select the corresponding device "Mitsubishi FX5U Series (SLMP)":

Read/Write address

Device

Address

Data    Indirect specify

### 5.7.3 Cable making

RJ45 Straight Through Cable (connected to HUB) or RJ45 Crossover Cable :



( Fig1 )



( Fig 2 )

#### 5.7.4 Device address

PLC address type	Range	Object type	Notes
X	0~1fff	Bit	External input coil
Y	0~1fff	Bit	External output coil
M	0~8191	Bit	Internal coil
L	0~8191	Bit	Locking relay
F	0~2047	Bit	Alarm
V	0~2047	Bit	Variable address relay
B	0~1fff	Bit	Linkage relay
TS	0~2047	Bit	Timer contacts
SS	0~2047	Bit	Holding delay timer relay
CS	0~1023	Bit	Counter contacts
SB	0~7ff	Bit	Special link relay
S	0~2047	Bit	Stepper coil
SM	0~2047	Bit	Special relay
D	0~65535	Word/DWord	Data register
W	0~1fff	Word/DWord	Linkage register
TC	0~2047	Word/DWord	Timer coil
TN	0~2047	Word/DWord	Current value
SC	0~2047	Word/DWord	Holding delay timer coil
SN	0~2047	Word/DWord	Holding delay timer present value
CC	0~1023	Word/DWord	Counter coil
CN	0~1023	Word/DWord	Counter current value
SW	0~7ff	Word/DWord	Special link register
SD	0~2047	Word/DWord	Special register
Z	0~19	Word/DWord	Variable register

## 6 Delta PLC Connection Instructions

This chapter mainly introduces the connection instructions between the touch screen and Delta PLC communication equipment.

**Note:**

- ( 1 )The Xinje TS series touch screen supports a maximum baud rate of 187.5K.
- ( 2 )During communication, please don't plug or unplug cables with power, as it may cause damage to the device's serial port.
- ( 3 )Upgrade of touch screen software version, there may be some changes in the communication protocol device address range. The device address range in the software shall prevail.

### 6.1 Delta AS series

#### 6.1.1 Device type

Series	CPU	Connected module	Port	Cable making	PLC model in Touchwin software
300 series	AS332T/P-A AS324MT-A AS320T/P-B AS300N-A	CPU direct connection	RS485	Fig1	Delta AS series (Modbus RTU)
200 series	AS228T/P/R-A AS218TX/PX/RX-A		RJ45	Fig 2	Delta AS series (Modbus TCP)

#### 6.1.2 Parameters

##### 1. RS485 communication

##### (1) HMI settings

Parameter	Recommend settings	Choices of settings	Note
PLC type	Delta AS series ( Modbus RTU )		None
Port	RS485		
Data bit	8		
Stop bit	1		
Parity	Even parity		
Baud rate	9600	9600/19200	
Station No.	1	0~255	

Delta AS series protocol default communication parameters:

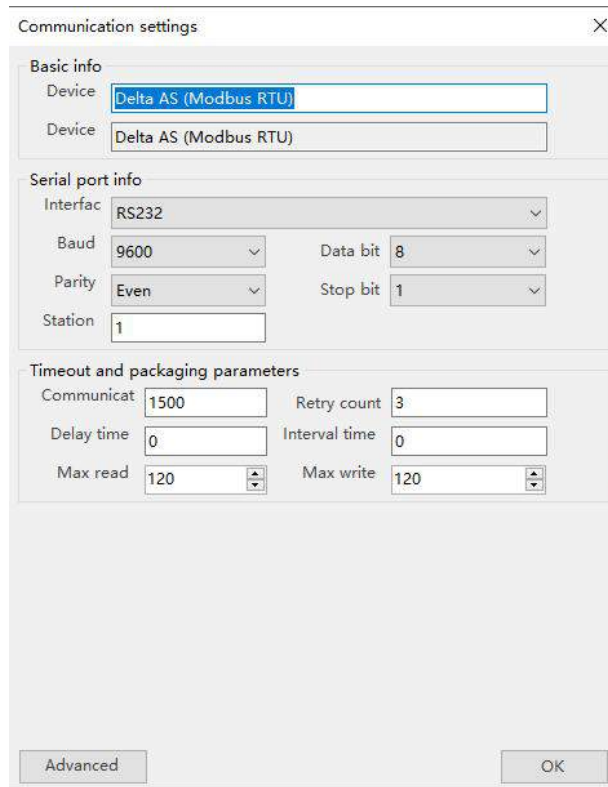

## 2. RJ45 communication

### (1) PLC settings

- ① Open the PLC programming software as shown in Figure 1, double-click in the project management area to open HWCONFI.



( Fig 1 )

- ② The pop-up box shown in Figure 2, double-click on the illustrated section.



( Fig 2 )

③ General settings for the Ethernet basic settings in the project bar, set the corresponding IP address of the PLC, as shown in Figure 3.



( Fig 3 )

## 2. HMI settings

(1) After selecting the human-machine interface model as - E, click to proceed to the next step, select "Net1" in the device list, and set the IP address used for the human-machine interface in "Set Local IP", as long as it doesn't conflict with other IPs in the network.

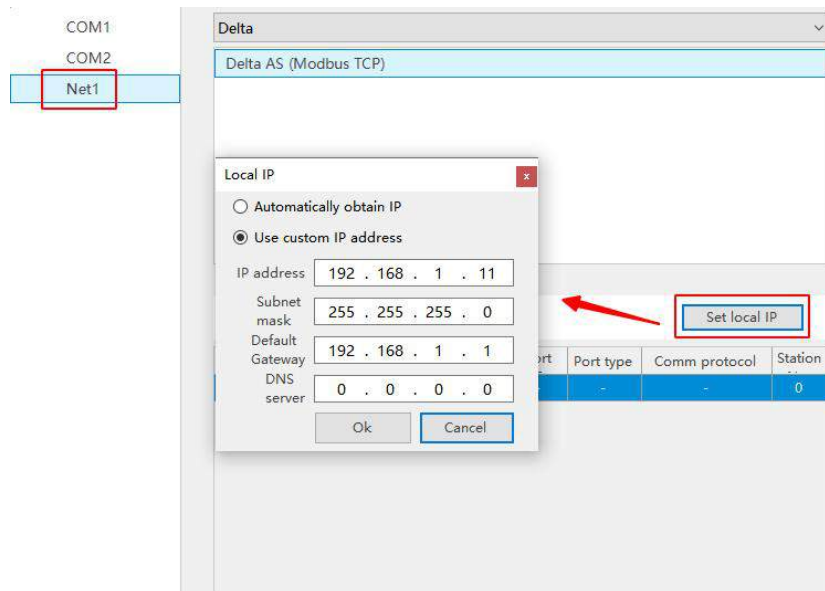

(2) Select "Net1", click the drop-down button, and select "Delta" from the brand list:

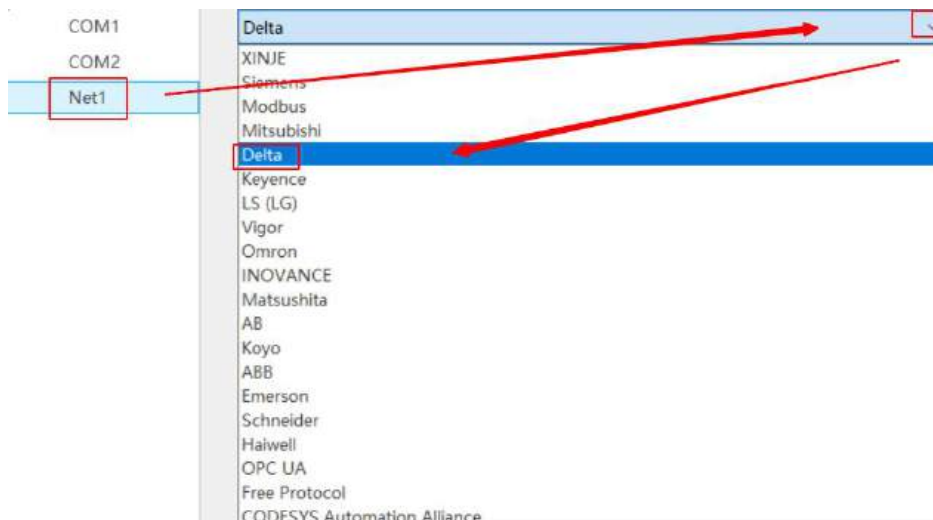

- (3) Click on "Modbus TCP" in the model list, then select "New Device" and set the communication parameters in the pop-up communication settings window. This IP address is the IP address of the Delta AS series PLC (which can be set through PLC software), and the port number is the "Local Port Number" (decimal) set in the PLC software. After setting up, click "Confirm".

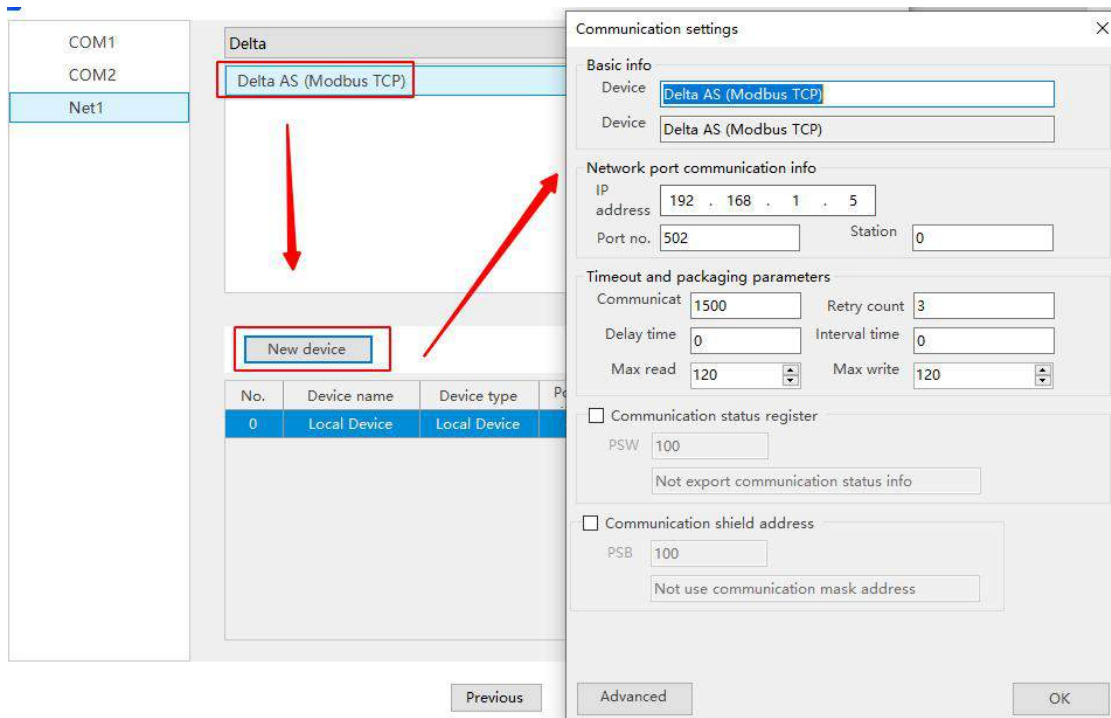

- (4) Check the "Communication Status Register", set PSW to 100, and select PSW100~PSW103 as the communication success number, communication failure number, communication timeout number, and communication error number. Customers can set this communication status address themselves.

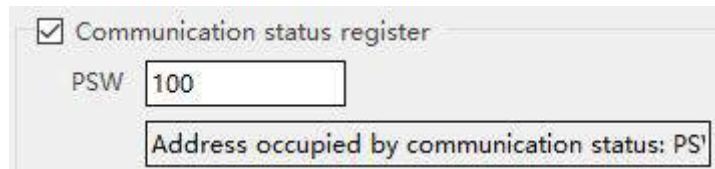

- (5) After setting up, click "OK" to end the setup and enter the screen editing interface. Place a data External input coil component on the screen and select it from the device drop-down bar, select the corresponding device "Delta AS Series (Modbus TCP)":

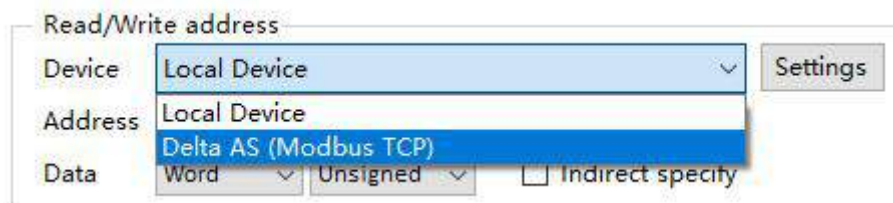

### 6.1.3 Cable making

- Delta AS series CPU (RS485 port):

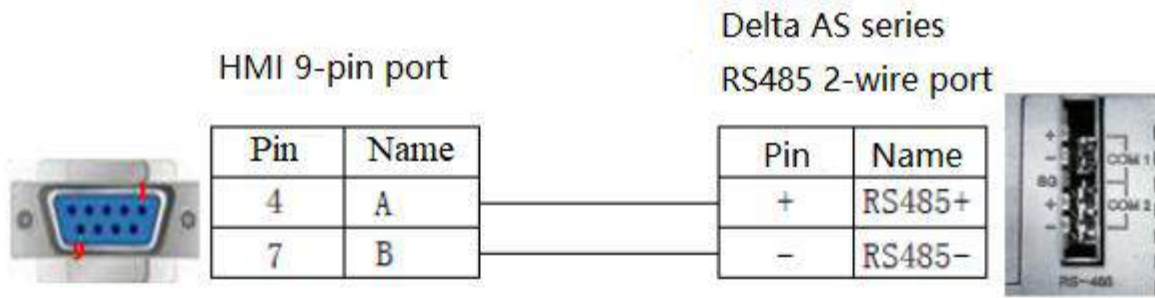

( Fig1 )

- RJ45 Straight Through Cable (connected to HUB) or RJ45 Crossover Cable :



( Fig 2 )

### 6.1.4 Device address

PLC address type	Range	Object type	Notes
X	0.0~63.15	Bit	External input coil
Y	0.0~63.15	Bit	External output coil
M	0~8191	Bit	Internal coil
S	0~2047	Bit	Stepper coil
T	0~511	Bit	Timer
C	0~511	Bit	Counter
HC	0~255	Bit	32-bit counter
D	0~29999	Word	Data register
E	0~9	Word	Data register
SR	0~2047	Word	Special data register

## 6.2 Delta AS series Ethernet

### 6.2.1 Device type

Series	CPU	Connected module	Port	Cable making	PLC model in Touchwin software
200 series	AS228T/P/R-A AS218TX/PX/RX-A	CPU direct connection	RJ45	Fig 2	Delta AS series (Modbus TCP)

### 6.2.2 Parameters

#### 1. RJ45 communication

##### (1) PLC settings

① Open the PLC programming software as shown in Figure 1, double-click in the project management area, and open HWCONFIG.



( Fig1 )

② Pop up box as shown in Figure 2, double-click on the illustrated section.



( Fig 2 )

③ General settings for the Ethernet basic settings in the project bar, set the corresponding IP address of the PLC, as shown in Figure 3.

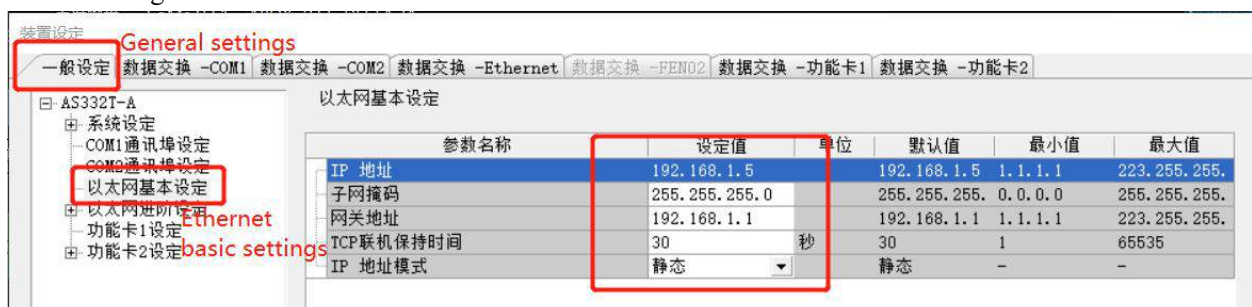

( Fig 3 )

## 2. HMI settings

- (1) After selecting the human-machine interface model as - E, click to proceed to the next step, select "Net1" in the device list, and set the IP address used for the human-machine interface in "Set Local IP", as long as it doesn't conflict with other IPs in the network.

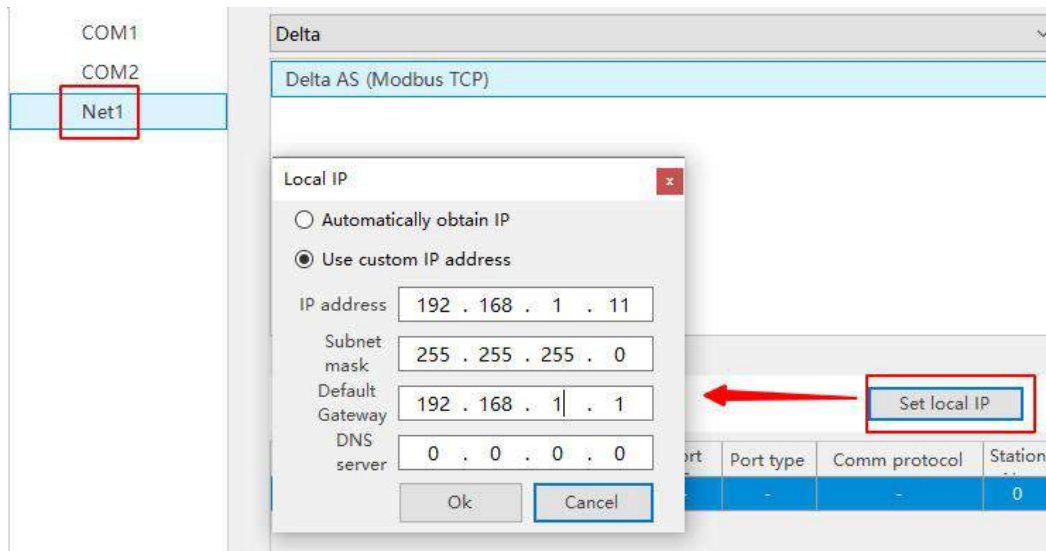

- (2) Select "Net1", click the drop-down button, and select "Delta" from the brand list:

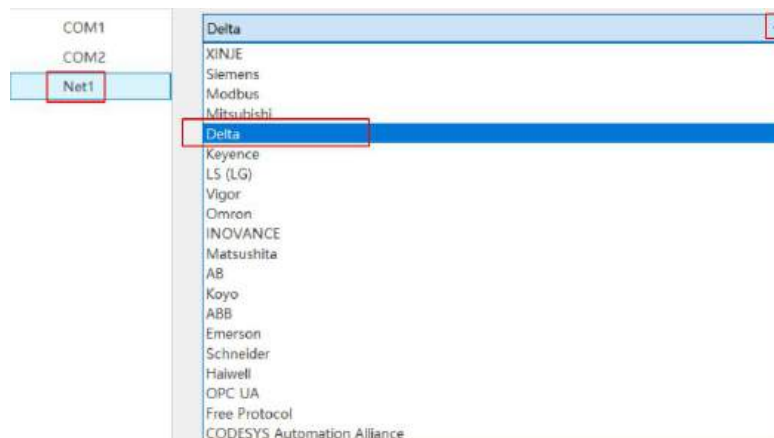

- (3) Click on "Modbus TCP" in the model list, then select "New Device" and set the communication parameters in the pop-up communication settings window. This IP address is the IP address of the Delta AS series PLC (which can be set through PLC software), and the port number is the "Local Port Number" (decimal) set in the PLC software. After setting up, click "Confirm".

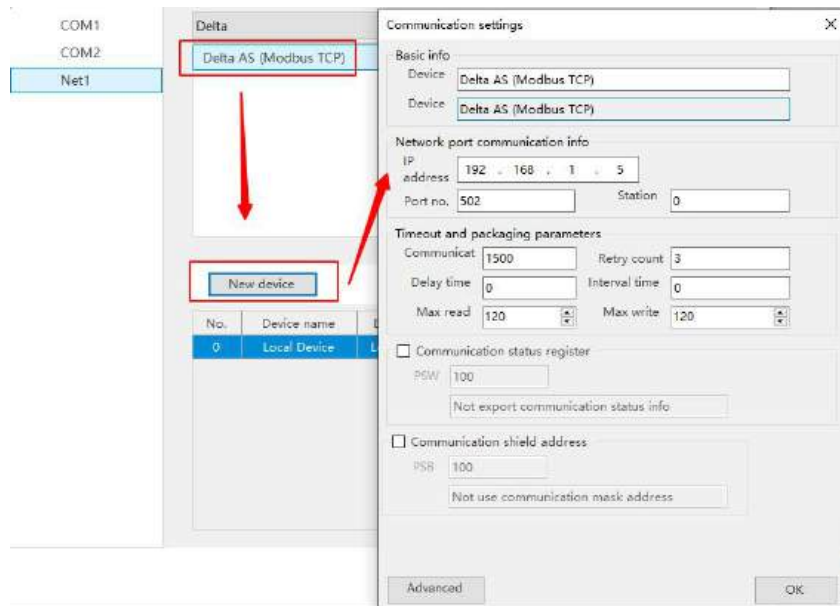

- (4) Check the "Communication Status Register", set PSW to 100, and select PSW100~PSW103 as the communication success number, communication failure number, communication timeout number, and communication error number. Customers can set this communication status address themselves.



- (5) After setting up, click "OK" to end the setup and enter the screen editing interface. Place a data External input coil component on the screen and select it from the device drop-down bar, select the corresponding device "Delta AS Series (Modbus TCP)":

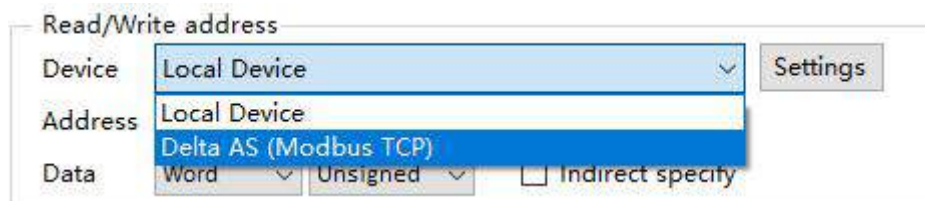

### 6.2.3 Cable making

1. RJ45 Straight Through Cable (connected to HUB) or RJ45 Crossover Cable :

Pin no.	Color		Pin no.	Color
1	White orange	—————	1	White green
2	orange	—————	2	Green
3	White green	—————	3	White orange
4	blue	—————	4	blue
5	White blue	—————	5	White blue
6	Green	—————	6	orange
7	White brown	—————	7	White brown
8	Brown	—————	8	Brown

( Fig 2 )

#### 6.2.4 Device address

PLC address type	Range	Object type	Notes
X	0.0~63.15	Bit	External input coil
Y	0.0~63.15	Bit	External output coil
M	0~8191	Bit	Internal coil
S	0~2047	Bit	Stepper coil
T	0~511	Bit	Timer
C	0~511	Bit	Counter
HC	0~255	Bit	32-bit counter
D	0~29999	Word	Data register
E	0~9	Word	Data register
SR	0~2047	Word	Special data register

## 6.3 Delta DVP series

### 6.3.1 Device type

Delta DVP Series	Connected module	Port	Cable making	PLC model in Touchwin software
DVP-EH series DVP-ES series DVP-EX series	CPU direct connection	RS232	Fig1	Delta DVP ( Modbus RTU ) or Delta DVP ( Modbus ASCII )
		RS485	Fig 2	
DVP-SS DVP-SA DVP-SC DVP-SX		RS232	Fig1	
		RS485	Fig 2	

### 6.3.2 Parameters

#### 1. HMI settings

Parameter	Recommend settings	Choices of settings	Note
PLC type	Delta DVP		None
Port	RS232	RS232/RS485	
Data bit	7		
Stop bit	1		
Parity	Even parity		
Baud rate	9600	9600/19200	
Station No.	1	0~255	

Delta (DVP) protocol default communication parameters:

The image displays two side-by-side screenshots of the 'Communication settings' dialog box. Both windows show the following parameters:

- Basic info:** Device: Delta DVP (Modbus RTU) (left) / Delta DVP (Modbus ASCII) (right); Device: Delta DVP (Modbus RTU) (left) / Delta DVP (Modbus ASCII) (right).
- Serial port info:** Interfac: RS232; Baud: 9600; Data bit: 8 (left) / 7 (right); Parity: Even; Stop bit: 1; Station: 1.
- Timeout and packaging parameters:** Communicat: 1000; Retry count: 3; Delay time: 0; Interval time: 0; Max read: 120; Max write: 120.

Buttons for 'Advanced', 'OK', and 'Cancel' are visible at the bottom of each window.

### 6.3.3 Cable making

1. RS232 port on the CPU :

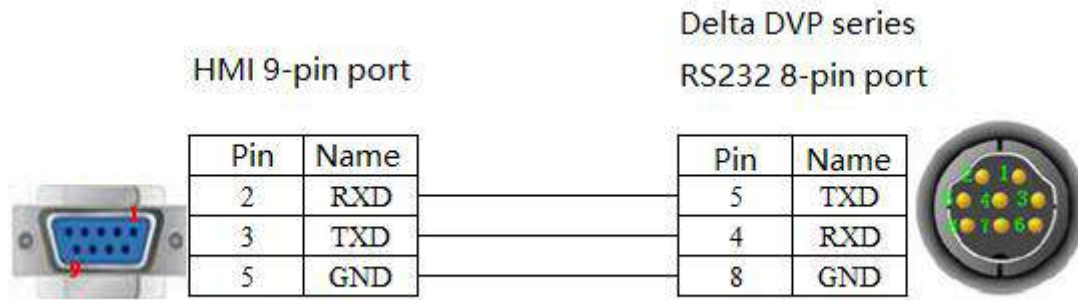

( Fig1 )

2. RS485 port on the CPU :

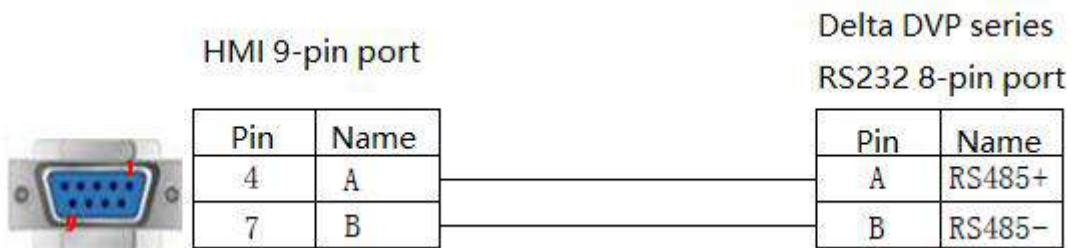

( Fig 2 )

### 6.3.4 Device address

PLC address type	Range	Object type	Notes
X	0~377	Bit	External input coil
Y	0~377	Bit	External output coil
M	0~4095	Bit	Internal coil
S	0~1023	Bit	Stepper coil
T	0~255	Bit	Timer
C	0~255	Bit	Counter
D	0~9999	Word/DWord	Data register
TD	0~255	Word/DWord	Timer
CD	0~255	Word/DWord	Counter
S	0~1023	Word/DWord	Used as a register
X	0~377	Word/DWord	Used as a register
Y	0~377	Word/DWord	Used as a register
M	0~7777	Word/DWord	Used as a register

# 7 Keyence PLC Connection Instructions

This chapter mainly introduces the connection instructions between the touch screen and the Keyence PLC communication equipment.

**Note:**

- ( 1 )The Xinje TS series touch screen supports a maximum baud rate of 187.5K.
- ( 2 )During communication, please don't plug or unplug cables with power, as it may cause damage to the device's serial port.
- ( 3 )Upgrade of touch screen software version, there may be some changes in the communication protocol device address range. The device address range in the software shall prevail.

## 7.1 Keyence KV series

### 7.1.1 Device type

CPU	Connected module	Port	Cable making	PLC model in Touchwin software
KV-10DR KV-24 KV-16 KV-40 KV-1000 KV-3000 KV-5000	CPU direct connection	RS232	Fig1	Keyence KV series
KZ-300	Serial port module KZ-L2	RS232	Fig 2, Fig 3	
		RS422	Fig 4	
KV-700	Serial port module KZ-L20	RS232	Fig 5 , Fig 6	
		RS422	Fig 7	

### 7.1.2 Parameters

#### 1. HMI settings

Parameter	Recommend settings	Choices of settings	Note
PLC type	Keyence KV series		None
Port	RS232	RS232/RS422	
Data bit	8		
Stop bit	1		
Parity	Even parity		
Baud rate	9600		
Station No.	1	0~255	

Keyence (KV) protocol default communication parameters:

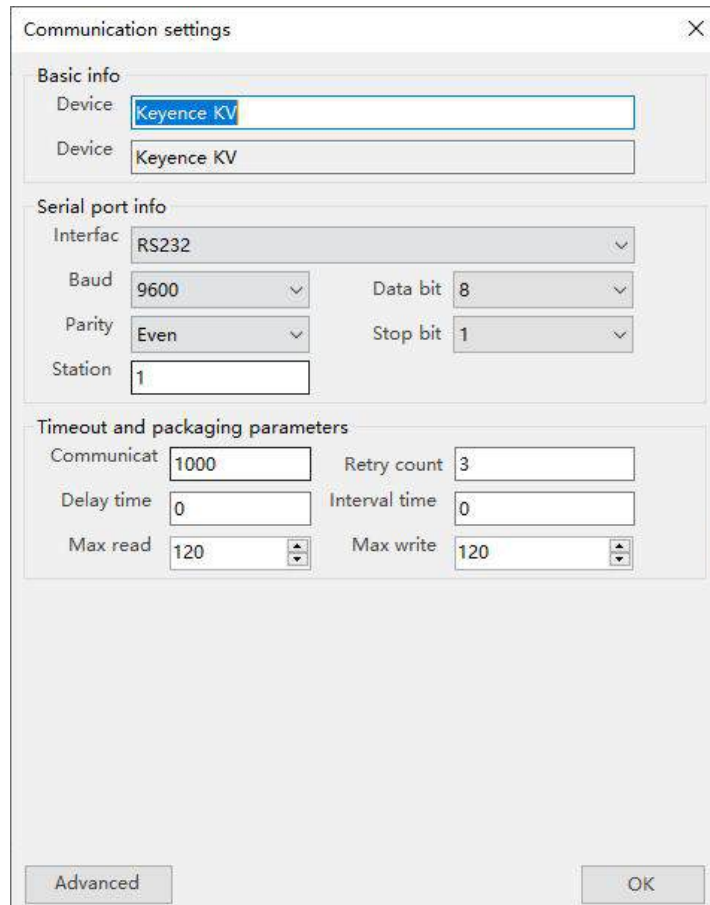

### 7.1.3 Cable making

1. The production diagram of the cable directly connecting to the RJ11 port of the CPU unit (RS232 port) is shown below:

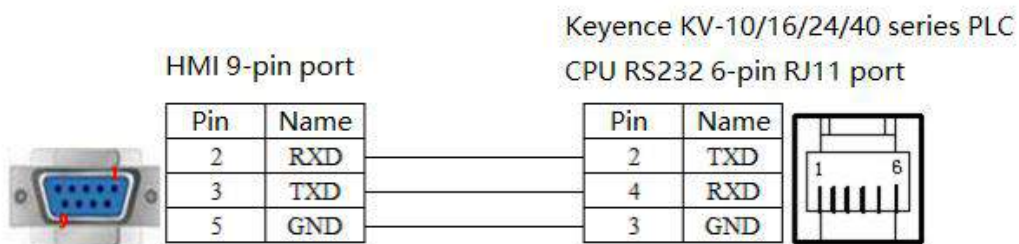

( Fig1 )

2. Connect the Keyence KZ-300 series PLC through the serial interface module KZ-L2 (Port1, RS232), and the cable fabrication diagram is shown below:

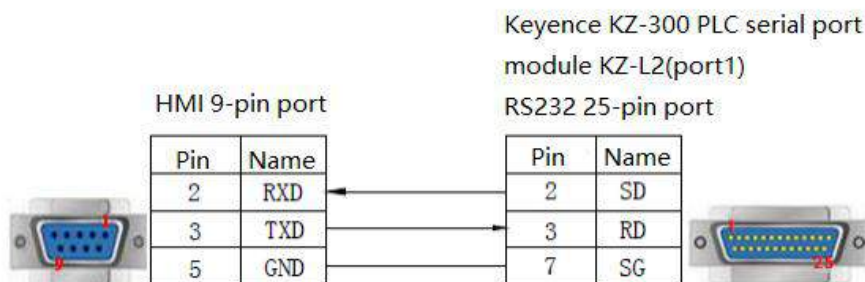

( Fig 2 )

3. Connect the Keyence KZ-300 series PLC through the serial interface module KZ-L2 (Port2, RS232), and the cable fabrication diagram is shown below:

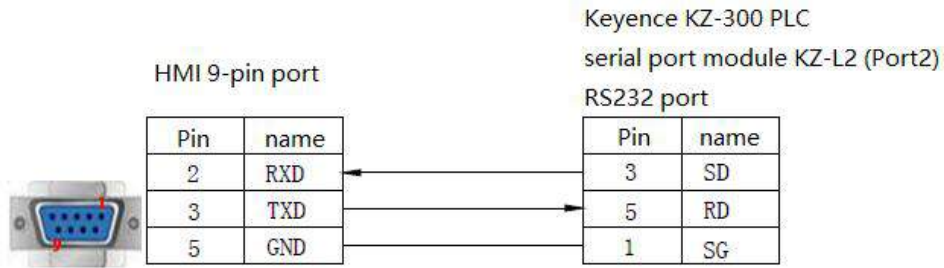

( Fig 3 )

4. Connect the Keyence KZ-300 series PLC through the serial interface module KZ-L2 (Port2, RS422), and the cable fabrication diagram is shown below:

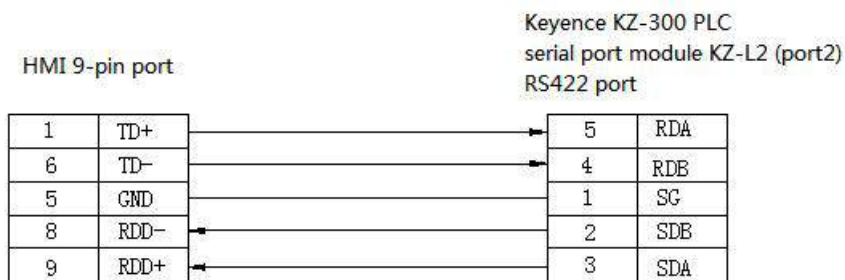

( Fig 4 )

5. Connect the Keyence KV-700 series PLC through the serial interface module KV-L20 (Port1, RS232), and the cable fabrication diagram is shown below:

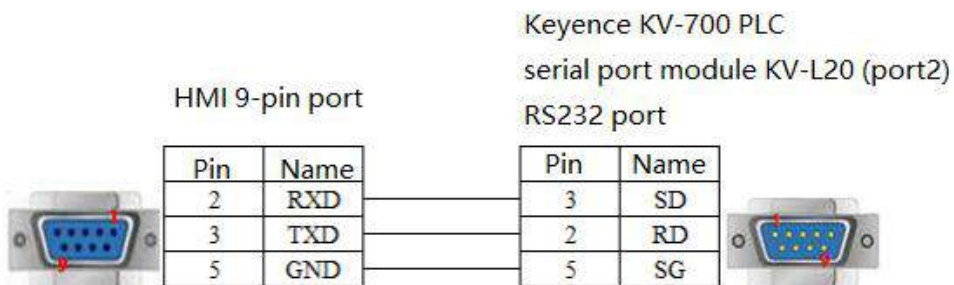

( Fig 5 )

6. Connect the Keyence KV-700 series PLC through the serial interface module KV-L20 (Port2, RS232), and the cable fabrication diagram is shown below:

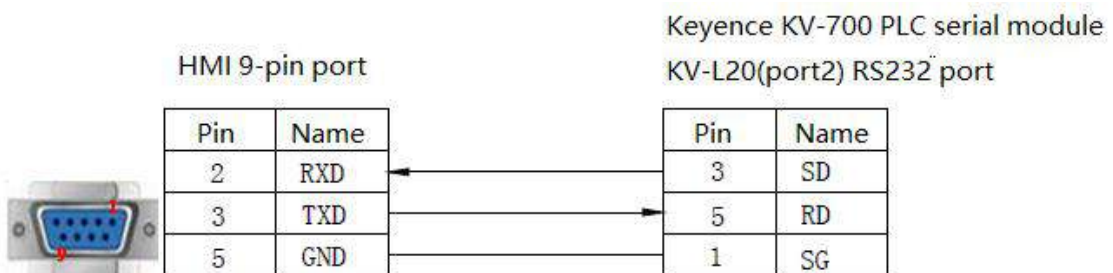

( Fig 6 )

7. Connect the Keyence KV-700 series PLC through the serial interface module KV-L20 (Port2, RS422), and

the cable fabrication diagram is shown below:

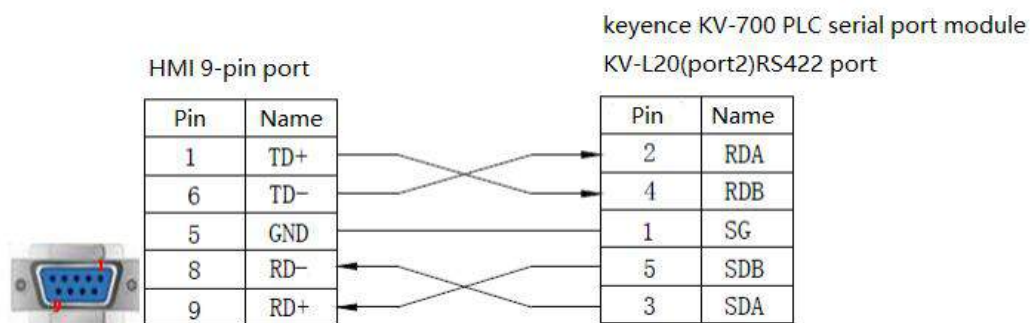

( Fig 7 )

#### 7.1.4 Device address

PLC address type	Range	Object type	Notes
R	0.00~999.15	Bit	Input relay
	5.0~999.15	Bit	Output relay
MR	0.00~999.15	Bit	Internal relay
LR	0.00~999.15	Bit	
CR	0.00~39.15	Bit	
T	0~3999	Bit	Timer
C	0~3999	Bit	Counter
DM	0~65534	Word/DWord	Data register
TM	0~11998	Word	Temporary data storage
EM	0~511	Word	Extended data storage
FM	0~65534	Word	Flash data storage
CM	0~32766	Word	
TDC	0~3999	Word	
CDC	0~3999	Word	
TS	0~3999	Word	Timer
CS	0~3999	Word	Counter

## 7.2 Keyence KV series Ethernet

### 7.2.1 Device type

Series	Port	Cable making	PLC model in Touchwin software
KV--L20V KV-700 KV-1000 KV-3000 KV-5000 KV-8000 KV-Nano	RJ45	Fig 1 or Fig 2	Keyence KV series( MC )

### 7.2.2 Parameters

#### 1. Keyence ( KV )( MC ) HMI settings

Communication settings

Basic info  
 Device: Keyence KV (MC)  
 Device: Keyence KV (MC)

Network port communication info  
 IP address: 192 . 168 . 0 . 10  
 Port no.: 5000      Station: 1

Timeout and packaging parameters  
 Communicat: 1000      Retry count: 3  
 Delay time: 0      Interval time: 0  
 Max read: 120      Max write: 120

Communication status register  
 PSW: 100  
 Not export communication status info

Communication shield address  
 PSB: 100  
 Not use communication mask address

Advanced      OK

### 7.2.3 Cable making

RJ45 Straight Through Cable (connected to HUB) or RJ45 Crossover Cable :

Pin no.	Color		Pin no.	Color
1	White orange	—————	1	White orange
2	orange	—————	2	orange
3	White green	—————	3	White green
4	blue	—————	4	blue
5	White blue	—————	5	White blue
6	Green	—————	6	Green
7	White brown	—————	7	White brown
8	Brown	—————	8	Brown

( Fig1 )

Pin no.	Color		Pin no.	Color
1	White orange	—————	1	White green
2	orange	—————	2	Green
3	White green	—————	3	White orange
4	blue	—————	4	blue
5	White blue	—————	5	White blue
6	Green	—————	6	orange
7	White brown	—————	7	White brown
8	Brown	—————	8	Brown

( Fig 2 )

#### 7.2.4 Device address

Keyence KV series( MC )

PLC address type	Range	Object type	Notes
R	0.00~1999.15	Bit	Input output relay
MR	0.00~3999.15	Bit	Internal relay
LR	0.00~999.15	Bit	
CR	0.00~999.15	Bit	
B	0~7FFF	Bit	Link relay
T	0~9999	Bit	Timer
C	0~9999	Bit	Counter
DM	0~65535	Word/DWord	Data register
EM	0~65535	Word/DWord	Extended data register
FM	0~524287	DDWord	FlashData register
CM	0~65535	Word/DWord	
ZF	0~524287	DDWord	Flash data register
W	0~7FFE	String	
T	0~9998	Word	Timer

---

C	0~9998	Word	Counter
R_Word	0~1998	Word	
MR_Word	0~3999	Word	
LR_Word	0~999	Word	
CR_Word	0~999	Word	

# 8 LG PLC Connection Instructions

This chapter mainly introduces the connection instructions between the touch screen and LG PLC communication equipment.

**Note:**

- ( 1 )The Xinje TS series touch screen supports a maximum baud rate of 187.5K.**
- ( 2 )During communication, please don't plug or unplug cables with power, as it may cause damage to the device's serial port.**
- ( 3 )Upgrade of touch screen software version, there may be some changes in the communication protocol device address range. The device address range in the software shall prevail.**

## 8.1 LG Master-K 80/120 series ( CNet )

The LG Master-K series PLC supports two communication methods: CPU (RS232) and expansion port CNet module.

### 8.1.1 Device type

Series	Connected module	Port	Cable making	PLC model in Touchwin software
K80 K120 K 200-K3p-07AS	CPURS232 communication port	RS232	Fig1	LG Master-K80/120 series
	CNet communication module	RS232	Fig 2	LG Master-K80/120 series( CNet )
		RS485	Fig 3	

### 8.1.2 Parameters

#### 1. Programming port communication

##### ( 1 )HMI settings

Parameter	Recommend settings	Choices of settings	Note
PLC type	LG Master-K80/120 series		None
Port	RS232		
Data bit	8		
Stop bit	1		
Parity	None Parity		
Baud rate	38400	9600/19200/38400	
Station No.	0		

LG Master-K80/120 series protocol default communication parameters:

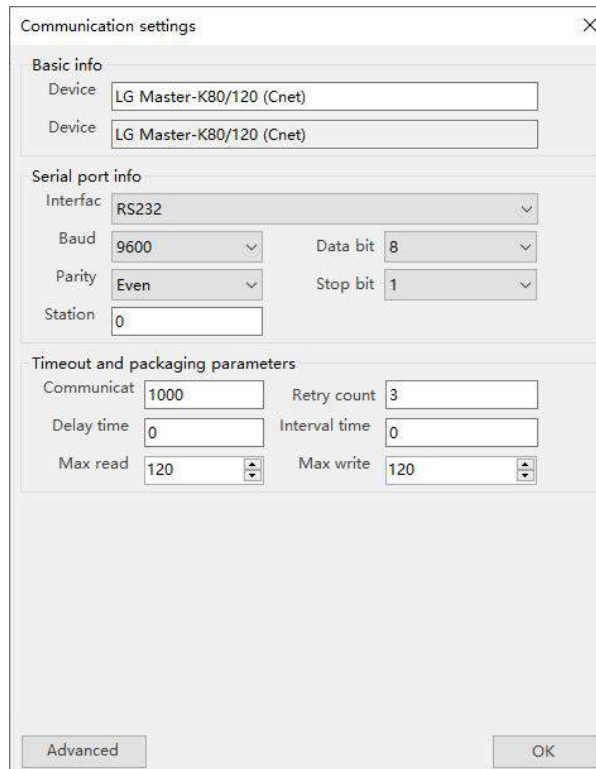

( 2 )PLC settings

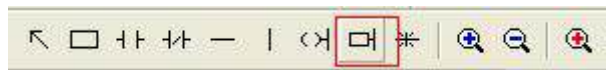

**Note:**

- (1) **Programming port communication, PLC doesn't need to set communication parameters.**
- (2) **Before communicating with the PLC, it's necessary to write an END command to the PLC, otherwise the PLC will report an error and the ERR will remain on.**

2. CNet communication

( 1 )HMI settings

Parameter	Recommend settings	Choices of settings	Note
PLC type	LG Master-K80/120 series ( CNet )		None
Port	RS232	RS232/RS485	
Data bit	8		
Stop bit	1		
Parity	Even parity		
Baud rate	9600	9600/19200/38400	
Station No.	1	0~31	

LG Master-K80/120 series (CNet) protocol default communication parameters:

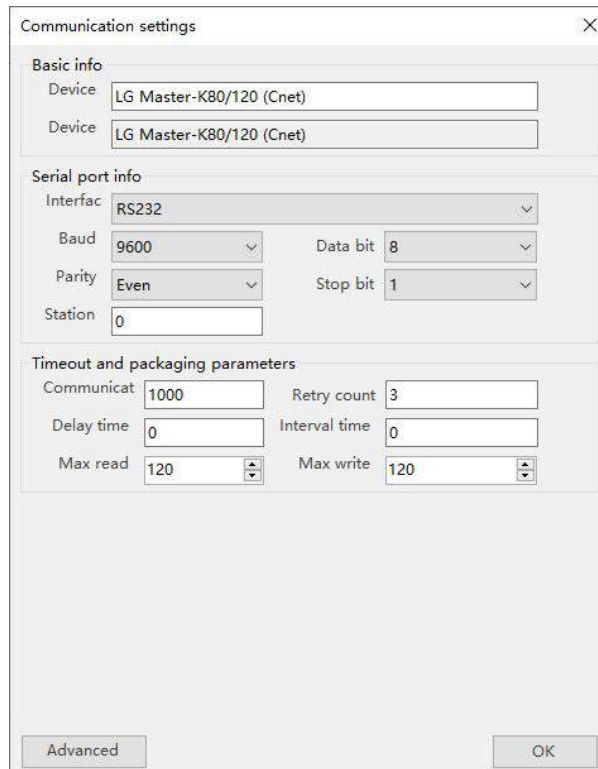

## (2) PLC settings

### ① RS232 communication



### ② RS485 communication



**Note:**

- ( 1 )Set the **BUILT-IN CNET** switch of the PLC body to **ON** state.
- ( 2 )Choose the correct **channel**, set the correct **communication channel, protocol, and mode**.
- ( 3 )Before communicating with the PLC, it's necessary to write an **END** command to the PLC, otherwise the PLC will report an error and the **ERR** will remain on.

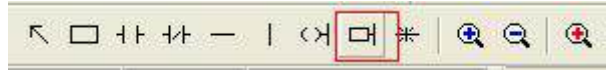

**8.1.3 Cable making**

- 1. Master-K80/120 programming port RS232 communication line:

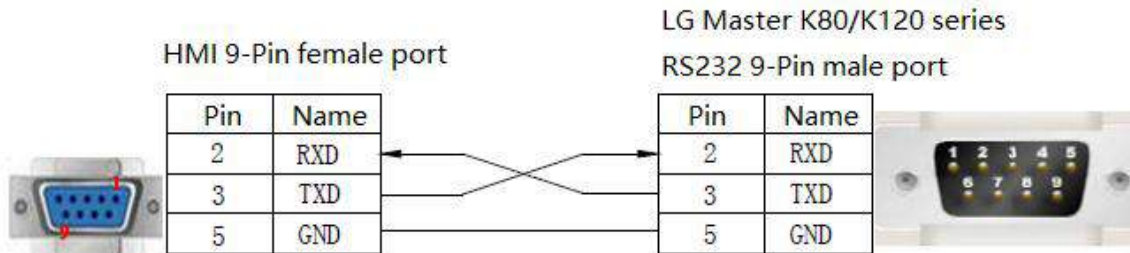

( Fig 1 )

- 2. Master K-CNet protocol RS232 communication line connection method:

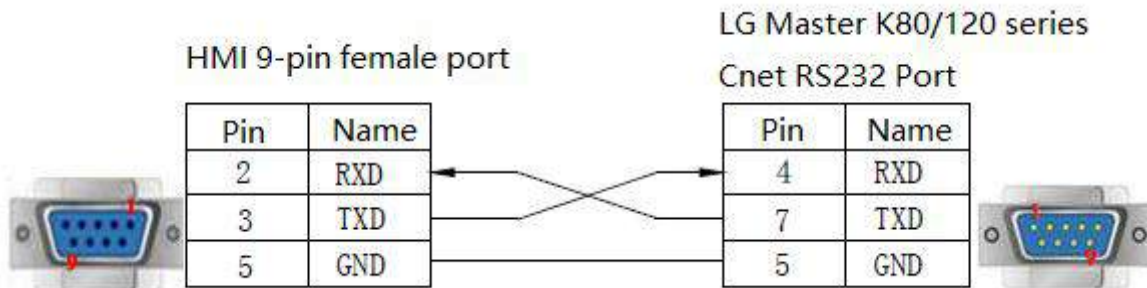

( Fig 2 )

- 3. Master K-CNet protocol RS485 communication line connection method

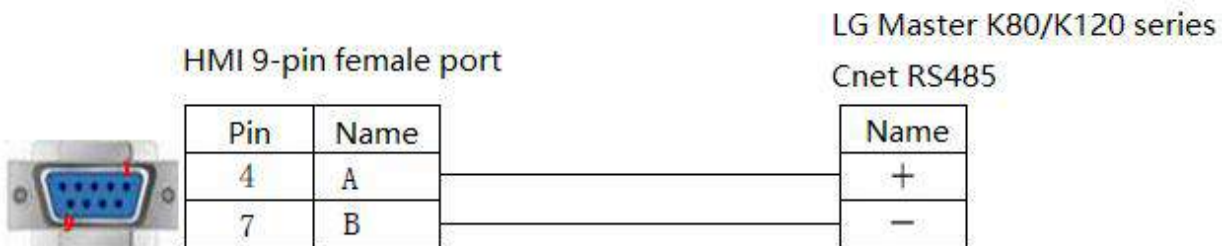

( Fig 3 )

**8.1.4 Device address**

LGMaster-K80/120 series PLC

PLC address type	Range	Object type	Notes
M	0.0~9999.F	Bit	Internal coil
L	0.0~9999.F	Bit	Link relay
K	0.0~9999.F	Bit	Holding relay

PLC address type	Range	Object type	Notes
T	0~9999	Bit	Timer
C	0~9999	Bit	Counter
D	0.0~9999.F	Bit	Bits in data registers
P	0.0~9999.F	Bit	Input/output, P4.0 starts as output
D	0~9999	Word/DWord	Data register
TD/T	0~9999	Word/DWord	Timer
CD/C	0~9999	Word/DWord	Counter
S	0~9999	Word/DWord	Used as a register
K	0~9999	Word/DWord	Used as a register
M	0~9999	Word/DWord	Used as a register
L	0~9999	Word/DWord	Used as a register
F	0~9999	Word/DWord	Used as a register

## 8.2 LG XBC series

### 8.2.1 Device type

Series	CPU	Connected module	Port	Cable making	PLC model in Touchwin software
XGB	XBC-DR20E XBC-DR30E	Programming port	RS232	Fig1	LG XBC ( CNetx )
		CNet port	RS232	Fig 2	LG Master-K 80/120 ( CNet )
			RS485	Fig 3	

### 8.2.2 Parameters

#### 1. Programming port communication

##### ( 1 )HMI settings

Parameter	Recommend settings	Choices of settings	Note
PLC type	LG XBC series ( CNetx )		None
Port	RS232		
Data bit	8		
Stop bit	1		
Parity	None Parity		
Baud rate	115200	9600/19200/38400/115200	
Station No.	0		

LG XBC series (CNetx) protocol default communication parameters:

**Note: The XGB series (CPU Direct) only supports 115200 baud rate and station number modification is prohibited.**

2. CNet communication

( 1 )HMI settings

Parameter	Recommend settings	Choices of settings	Note
PLC type	LG Master-K 80/120 series ( CNet )		None
Port	RS232	RS232/RS485	
Data bit	8		
Stop bit	1		
Parity	None Parity		
Baud rate	9600	9600/19200/38400	
Station No.	1	0~31	

LG Master-K 80/120 series (CNet) protocol default communication parameters:

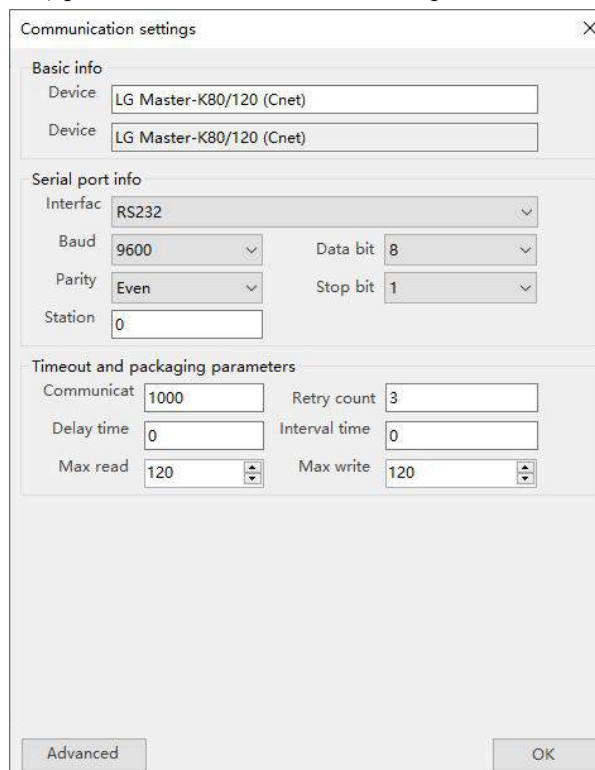

( 2 )PLC settings

a. RS232 communication

Tools-Network Manager sets communication parameters:

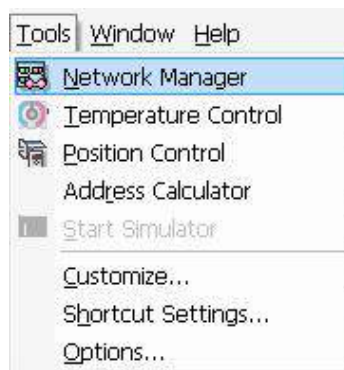

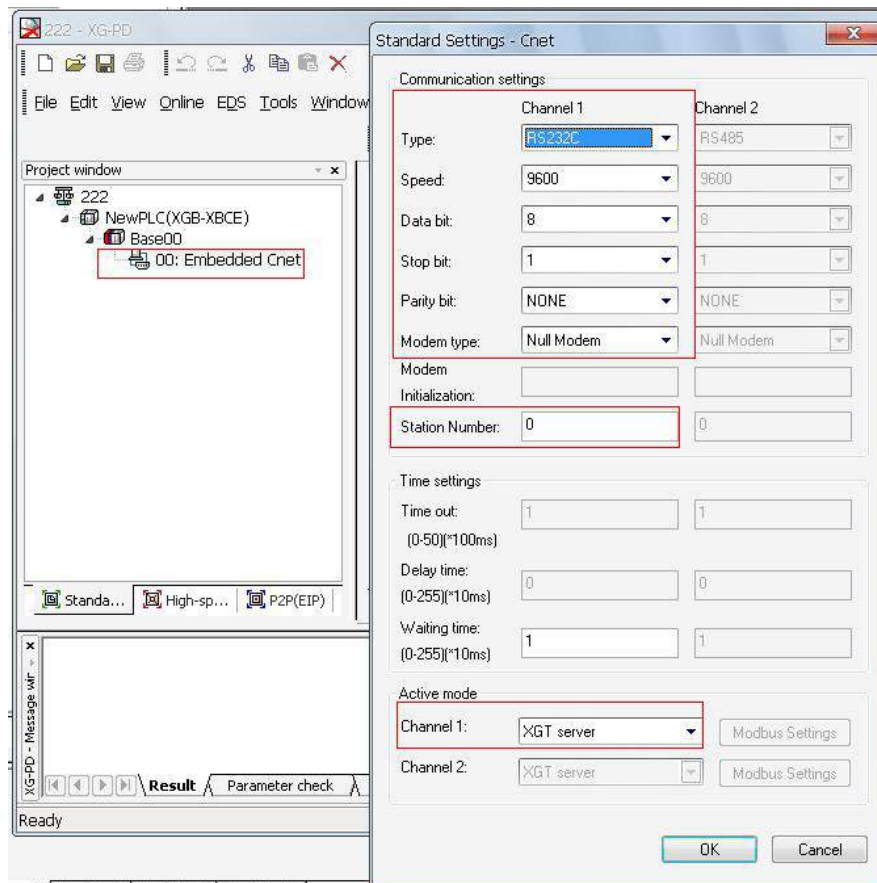

b. RS485 communication

Tools-Network Manager sets communication parameters:

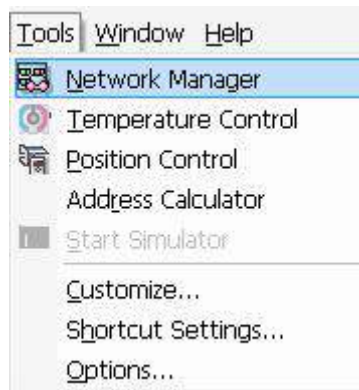

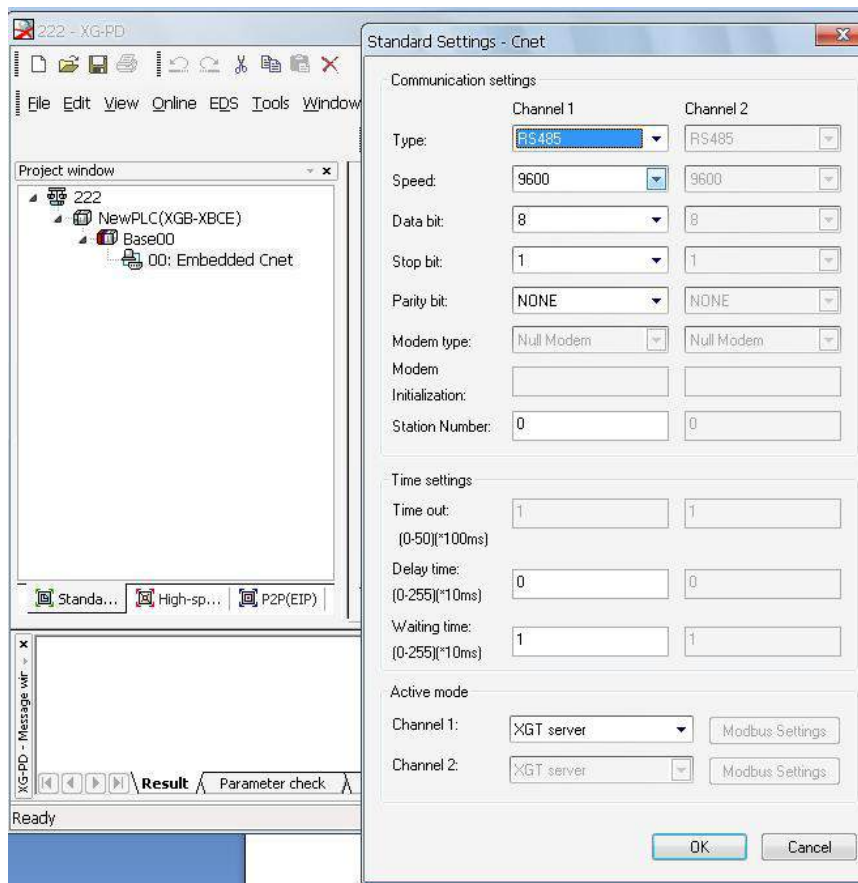

### 8.2.3 Cable making

#### 1. RS232 port

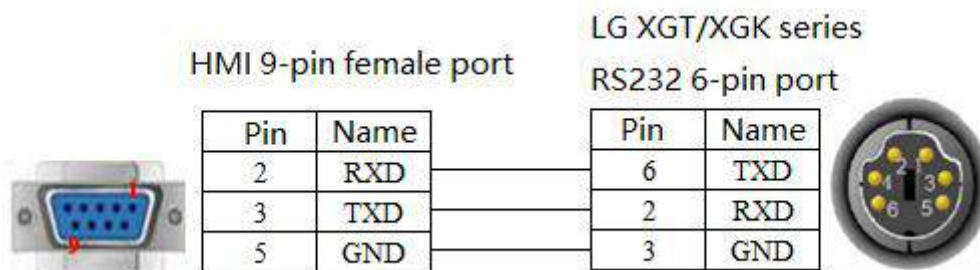

( Fig1 )

#### 2. CNet RS232 port

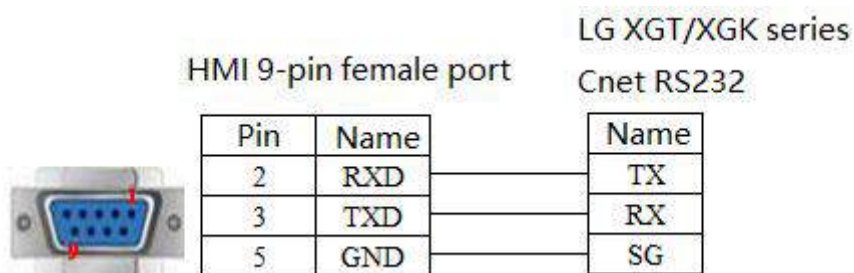

( Fig 2 )

#### 3. CNet RS485 port

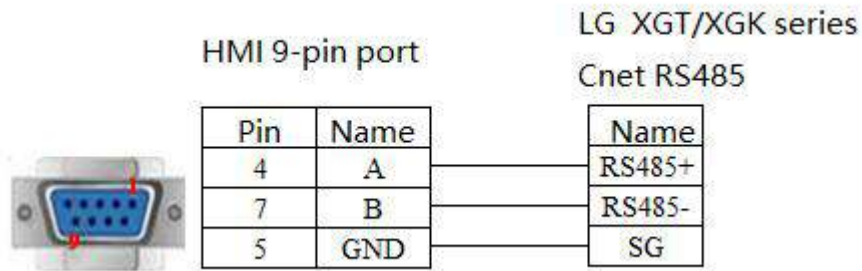

( Fig 3 )

#### 8.2.4 Device address

PLC address type	Range	Object type	Notes
P	0.0~65535.F	Bit	External input coil/External output coil
	0~65535	Word/DWord	Data register
M	0.0~65535.F	Bit	Internal coil
	0~65535	Word/DWord	Data register
L	0.0~65535.F	Bit	External output coil
	0~65535	Word/DWord	Data register
F	0.0~65535.F	Bit	Internal special relay
	0~65535	Word/DWord	Internal special data register
T	0~65535	Word/DWord	Current value of timer
	0~65535	Bit	Timer
C	0~65535	Word/DWord	Counter current value
	0~65535	Bit	Counter
D	0~65535	Word/DWord	Data register
	0.0~65535.F	Bit	Data register bit taking
S	0~65535	Bit	Stepper coil
K	0~65535	Word/DWord	Save Data Register
	0.0~65535.F	Bit	Save relay
Z	0~65535	Word/DWord	Index data register
	0.0~65535.F	Bit	Index relay
N	0~65535	Word/DWord	Communication register
	0.0~65535.F	Bit	Communication relay
R	0~65535	Word/DWord	Data register
	0.0~65535.F	Bit	Relay
ZR	0~65535	Word/DWord	Data register
	0.0~65535.F	Bit	Relay
TS	0~65535	Word/DWord	Timer setting value
CS	0~65535	Word/DWord	Counter setting value

## 8.3 LG XEC series ( CNet )

### 8.3.1 Device type

Series	CPU	Connected module	Port	Cable making	PLC model in Touchwin software
XGT		Program port	RS232	Fig1	LG XEC series ( CNet )
XGK	XGK-CPUS				

### 8.3.2 Parameters

#### 1. HMI settings

Parameter	Recommend settings	Choices of settings	Note
PLC type	LG XEC series ( CNet )		None
Port	RS232		
Data bit	8		
Stop bit	1		
Parity	None Parity		
Baud rate	115200		
Station No.	0		

LG XEC series (CNet) protocol default communication parameters:

### 8.3.3 Cable making

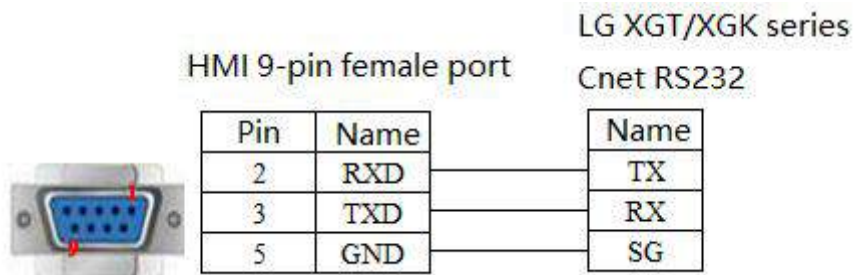

( Fig1 )

### 8.3.4 Device address

PLC address type	Range	Object type	Notes
I	0.0~255.F	Bit	Variable
	0~255	Word/DWord	Data register
Q	0.0~255.F	Bit	Variable
	0~255	Word/DWord	Data register
M	0.0~16383.F	Bit	Direct variable register
	0~16383	Word/DWord	Direct variable relay
L	0.0~4095.F	Bit	Communication relay
	0~4095	Word/DWord	Communication register
N	0~10239	Word/DWord	P2P parameters
	0.0~10239.F	Bit	P2P parameters
K	0~8191	Word/DWord	PID flag
	0.0~8191.F	Bit	PID flag
U	0~11	Word/DWord	Analog module data flag
	0.0~11.F	Bit	Analog module data flag
R	0~16383	Bit	Direct variables
	0.0~16383.F	Word/DWord	Direct variables
A	0~32767	Word/DWord	Symbolic variable register
	0.0~32767.F	Bit	Symbolic variable relay
W	0~32767	Word/DWord	Direct variable register
	0.0~32767.F	Bit	Direct variable relay
F	0~2047	Word/DWord	Special register
	0.0~2047.F	Bit	Special relay

## 8.4 LG XGT/XGK/XGB series

### 8.4.1 Device type

Series	Port	Cable making	PLC model in Touchwin software
LG XGT	RJ45	Fig 1 or Fig 2	LG XGT/XGK/XGB

### 8.4.2 Parameters

Taking LG XGT series PLC as an example, explain the communication settings of LG XGT/XGK/XGB series protocol equipment.

#### 1. PLC settings

Open the PLC software and set the IP address of the PLC to 192.168.6.10 in the Ethernet settings.

#### 2. HMI settings

- (1) After selecting the human-machine interface model as - E, click to proceed to the next step, select "Net1" in the device list, and set the IP address used for the human-machine interface in "Set Local IP". As long as it doesn't conflict with other IPs in the network, in this example, the PLC IP is 192.168.6.10, and the device itself can be set to 192.168.6.11.

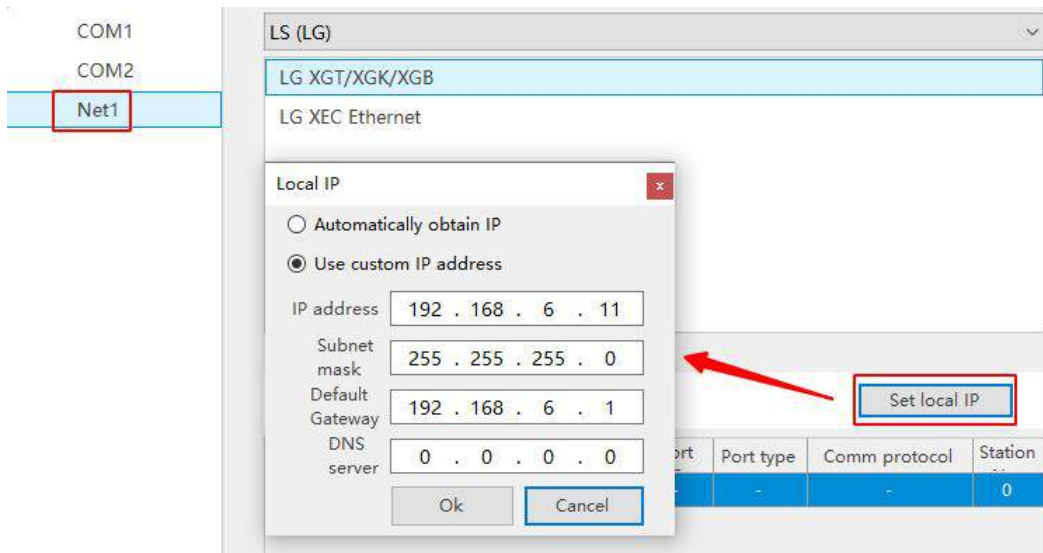

- (2) Select "Net1", click the drop-down button, and select "LS (LG)" from the brand list:



- (3) Click on "LG XGT/XGK/XGB Series" in the model list, then select "New Device" and set the communication parameters in the pop-up communication settings window. This IP address is the IP address of the LG XGT/XGK/XGB series PLC (which can be set through PLC software), and the port number is the "Local Port Number" (decimal) set in the PLC software. After setting up, click "Confirm".

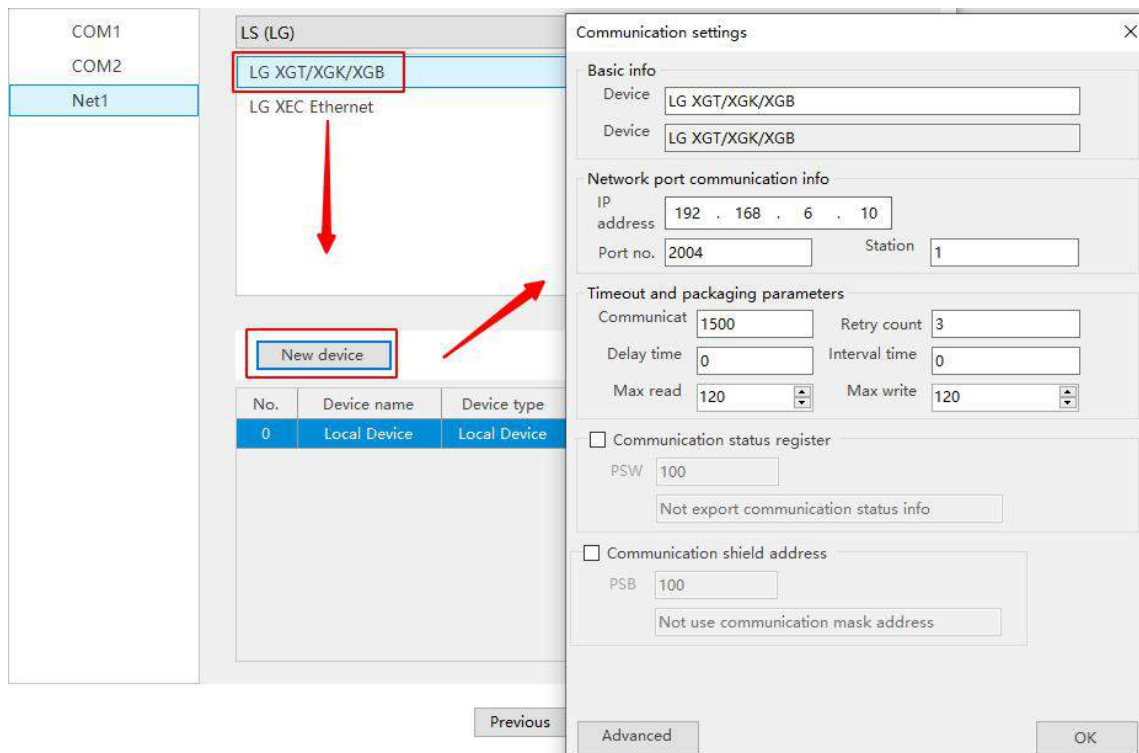

- (4) Check the "Communication Status Register", set PSW to 100, and select PSW100~PSW103 as the communication success number, communication failure number, communication timeout number, and communication error number. Customers can set this communication status address themselves.



- (5) After setting up, click "OK" to end the setup and enter the screen editing interface. Place a data External input coil component on the screen and select it from the device drop-down bar, select the corresponding device "LG XGT/XGK/XGB series":

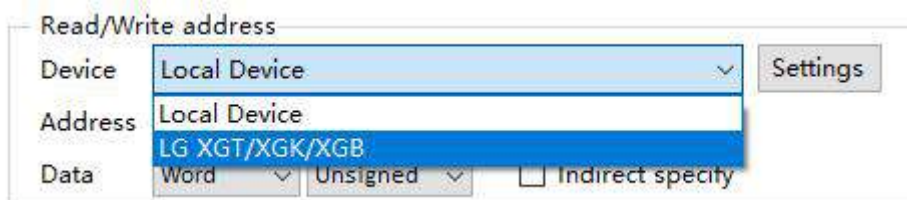

### 8.4.3 Cable making

RJ45 Straight Through Cable (connected to HUB) or RJ45 Crossover Cable :

Pin no.	Color		Pin no.	Color
1	White orange	—————	1	White orange
2	orange	—————	2	orange
3	White green	—————	3	White green
4	blue	—————	4	blue
5	White blue	—————	5	White blue
6	Green	—————	6	Green
7	White brown	—————	7	White brown
8	Brown	—————	8	Brown

( Fig1 )

Pin no.	Color		Pin no.	Color
1	White orange	—————	1	White green
2	orange	—————	2	Green
3	White green	—————	3	White orange
4	blue	—————	4	blue
5	White blue	—————	5	White blue
6	Green	—————	6	orange
7	White brown	—————	7	White brown
8	Brown	—————	8	Brown

( Fig 2 )

#### 8.4.4 Device address

PLC address type	Range	Object type	Notes
P	0.0~65535.F	Bit	External input coil/External output coil
	0~65535	Word/DWord	Data register
M	0.0~65535.F	Bit	Internal coil
	0~65535	Word/DWord	Data register
L	0.0~65535.F	Bit	Communication output coil
	0~65535	Word/DWord	Communication register
F	0.0~65535.F	Bit	Internal special relay
	0~65535	Word/DWord	Internal special data register
T	0~65535	Word/DWord	Current value of timer
	0~65535	Bit	Timer
C	0~65535	Word/DWord	Counter current value
	0~65535	Bit	Counter
D	0~65535	Word/DWord	Data register
	0.0~65535.F	Bit	Data register bit taking
S	0~65535	Bit	Stepper coil
K	0~65535	Word/DWord	Save Data Register

PLC address type	Range	Object type	Notes
	0.0~65535.F	Bit	Save relay
Z	0~65535	Word/DWord	Index data register
	0.0~65535.F	Bit	Index relay
N	0~65535	Word/DWord	Communication register
	0.0~65535.F	Bit	Communication relay
R	0~65535	Word/DWord	Data register
	0.0~65535.F	Bit	Relay
ZR	0~65535	Word/DWord	Data register
	0.0~65535.F	Bit	Relay
TS	0~65535	Word/DWord	Timer setting value
CS	0~65535	Word/DWord	Counter setting value

## 8.5 LG XEC series Ethernet

### 8.5.1 Device type

Series	Port	Cable making	PLC model in Touchwin software
LG XGT series	RJ45	Fig 1 or Fig 2	LG XEC series Ethernet

### 8.5.2 Parameters

Taking LG XEC series PLC as an example, explain the communication settings of LG XEC series Ethernet protocol equipment.

#### 1. PLC settings

Open the PLC software and set the IP address of the PLC to 192.168.6.2 in the Ethernet settings.

#### 2. HMI settings

- (1) After selecting the human-machine interface model as - E, click to enter the next step, select "Net1" in the device list, and set the IP address used for the human-machine interface in "Set Local IP". As long as it doesn't conflict with other IPs in the network, it's sufficient, in this example, the PLC station number is 192.168.6.2, and the device itself can be set to 192.168.6.11.

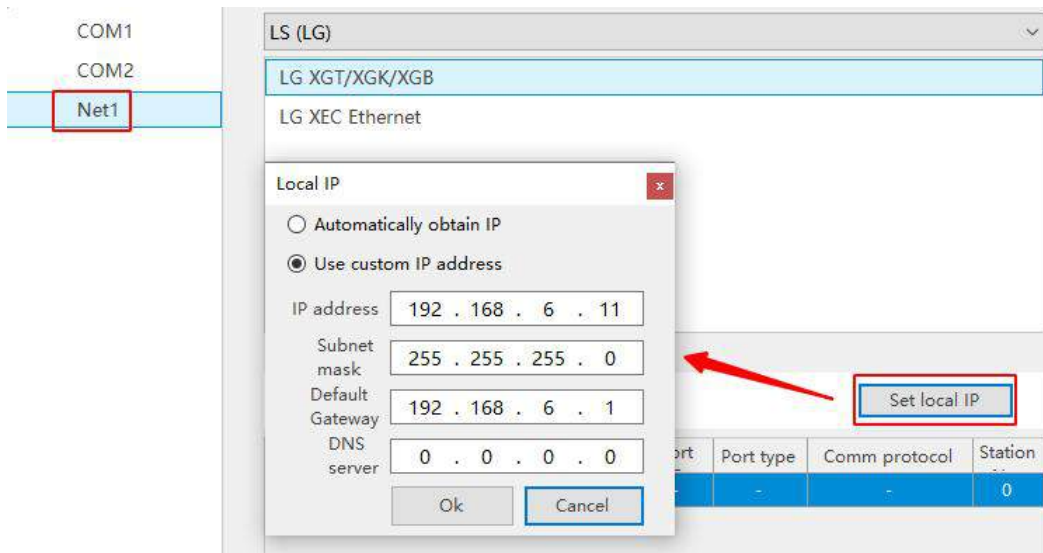

- (2) Select "Net1", click the drop-down button, and select "LS(LG)" from the brand list:



- (3) Click on "LG XEC Series Ethernet" in the model list, then select "New Device" and set the communication parameters in the pop-up communication settings window. This IP address is the IP address of the LG XEC series PLC (which can be set through PLC software), and the port number is the "Local Port Number" (decimal) set in the PLC software. After setting up, click "Confirm".

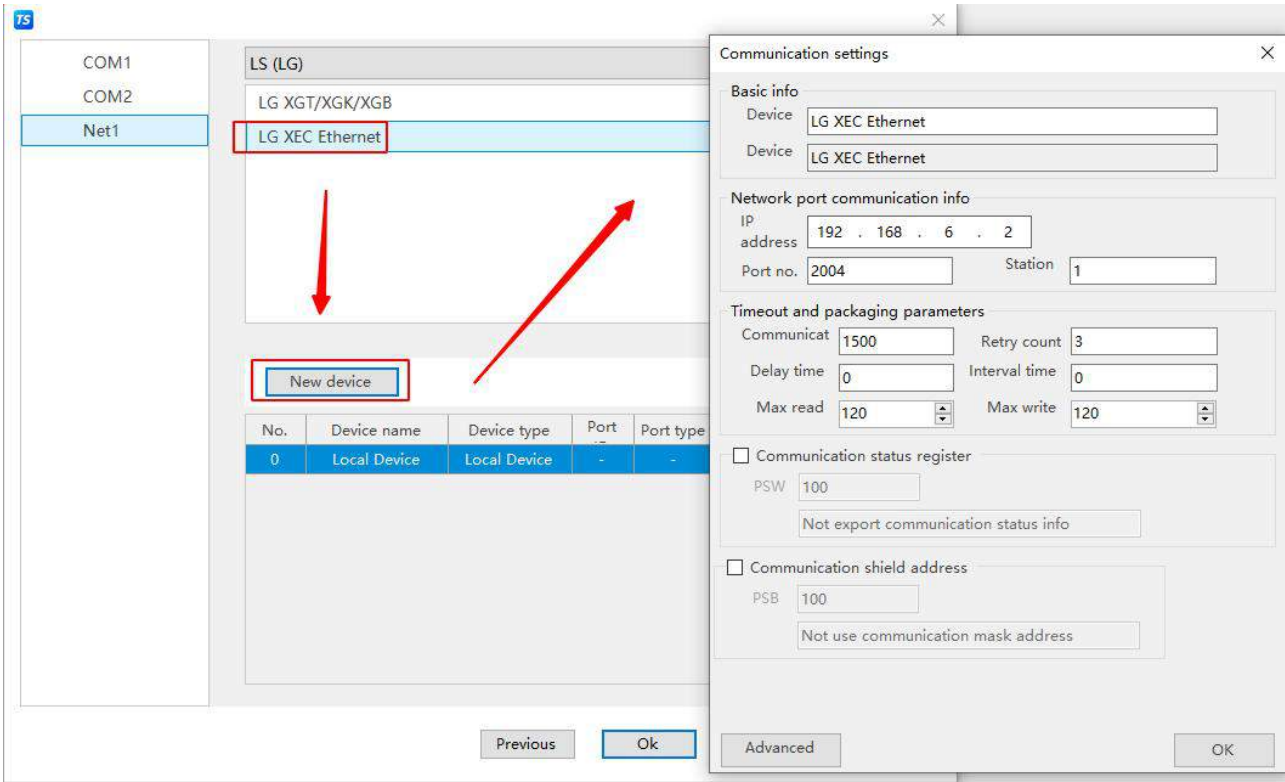

- (4) Check the "Communication Status Register", set PSW to 100, and select PSW100~PSW103 as the communication success number, communication failure number, communication timeout number, and communication error number. Customers can set this communication status address themselves.

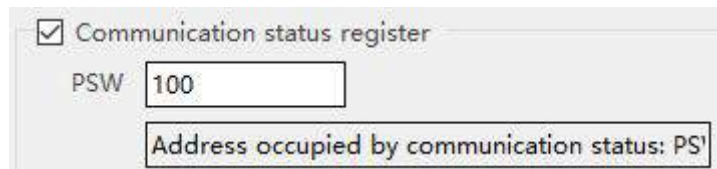

- (5) After setting up, click "OK" to end the setup and enter the screen editing interface. Place a data external input coil component on the screen and select it from the device drop-down bar, select the corresponding device "LG XEC series":

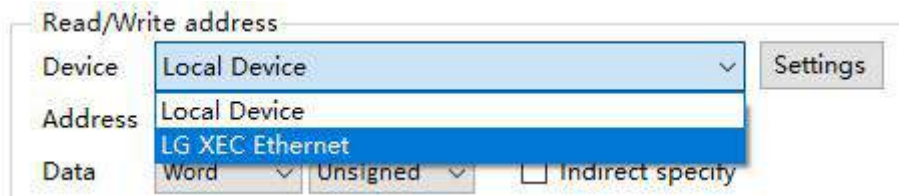

### 8.5.3 Cable making

RJ45 Straight Through Cable (connected to HUB) or RJ45 Crossover Cable :

Pin no.	Color		Pin no.	Color
1	White orange	—————	1	White orange
2	orange	—————	2	orange
3	White green	—————	3	White green
4	blue	—————	4	blue
5	White blue	—————	5	White blue
6	Green	—————	6	Green
7	White brown	—————	7	White brown
8	Brown	—————	8	Brown

( Fig1 )

Pin no.	Color		Pin no.	Color
1	White orange	—————	1	White green
2	orange	—————	2	Green
3	White green	—————	3	White orange
4	blue	—————	4	blue
5	White blue	—————	5	White blue
6	Green	—————	6	orange
7	White brown	—————	7	White brown
8	Brown	—————	8	Brown

( Fig 2 )

#### 8.5.4 Device address

PLC address type	Range	Object type	Notes
I	0.0~255.F	Bit	Variable
	0~255	Word/DWord	Data register
Q	0.0~255.F	Bit	Variable
	0~255	Word/DWord	Data register
M	0.0~16383.F	Bit	Direct variable register
	0~16383	Word/DWord	Direct variable relay
L	0.0~4095.F	Bit	Communication relay
	0~4095	Word/DWord	Communication register
N	0~10239	Word/DWord	P2P parameters
	0.0~10239.F	Bit	P2P parameters
K	0~8191	Word/DWord	PID flag
	0.0~8191.F	Bit	PID flag
U	0~11	Word/DWord	Analog module data flag
	0.0~11.F	Bit	Analog module data flag
R	0~16383	Bit	Direct variables
	0.0~16383.F	Word/DWord	Direct variables

---

A	0~32767	Word/DWord	Symbolic variable register
	0.0~32767.F	Bit	Symbolic variable relay
W	0~32767	Word/DWord	Direct variable register
	0.0~32767.F	Bit	Direct variable relay
F	0~2047	Word/DWord	Special register
	0.0~2047.F	Bit	Special relay

# 9 Vigor PLC Connection Instructions

This chapter mainly introduces the connection instructions between the touch screen and the Vigor PLC communication equipment.

**Note:**

- ( 1 )The Xinje TS series touch screen supports a maximum baud rate of 187.5K.
- ( 2 )During communication, please don't plug or unplug cables with power, as it may cause damage to the device's serial port.
- ( 3 )Upgrade of touch screen software version, there may be some changes in the communication protocol device address range. The device address range in the software shall prevail.

## 9.1 Vigor VB/VH series

### 9.1.1 Device type

Series	CPU	Connected module	Port	Cable making	PLC model in Touchwin software
VB	VB0-14M VB0-20M VB0-28M VB0-32M	CPU direct connection	RS232	Fig1	Vigor VB series
	VB1-14MT-D VB1-24MT-D VB1-32MTMT-D VB2-16M VB2-32M	Connect to the extension card	RS232	Fig 2	
			RS422	Fig 3	
			RS485	Fig 4	
VH	VH -14MR	CPU direct connection	RS232	Fig1	

### 9.1.2 Parameters

#### 1. HMI settings

Parameter	Recommend settings	Choices of settings	Note
PLC type	Vigor VB series		None
Port	RS232	RS232/RS485/RS422	
Data bit	7		
Stop bit	1		
Parity	Even parity		
Baud rate	19200		
Station No.	0		

The default communication parameters for the Vigor VB series protocol are:

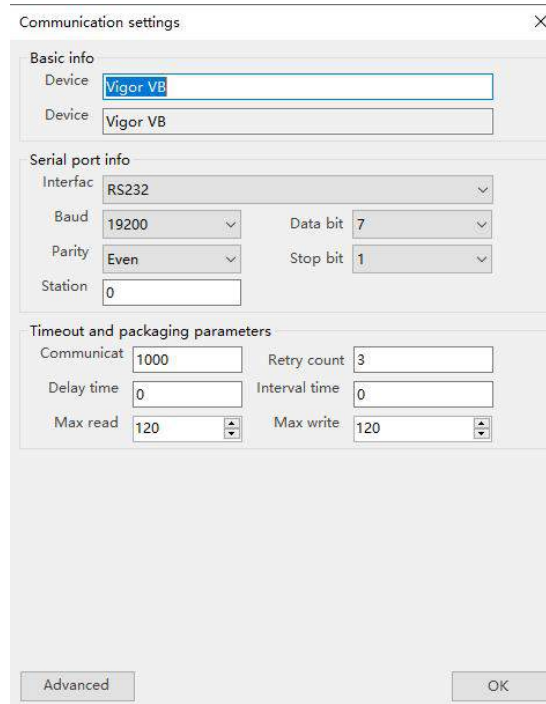

### 9.1.3 Cable making

#### 1. CPU RS232 USB-A:

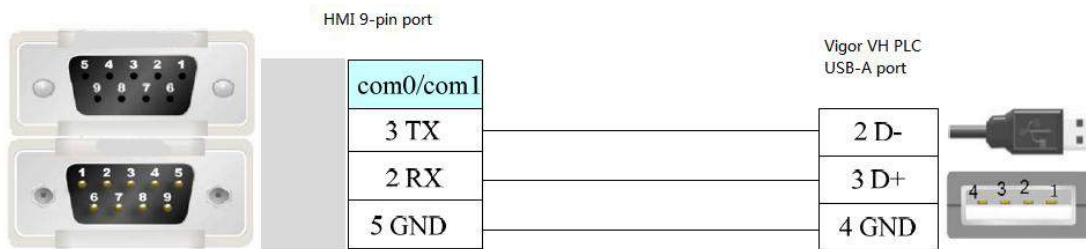

( Fig1 )

#### 2. CPU direct connection or RS232 extension card:

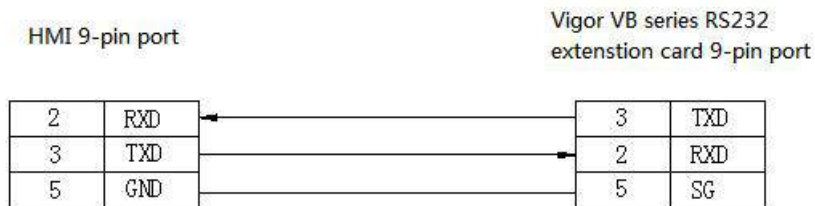

( Fig 2 )

#### 3. CPU direct connection or RS485 extension card:

##### (1) RS422 connection

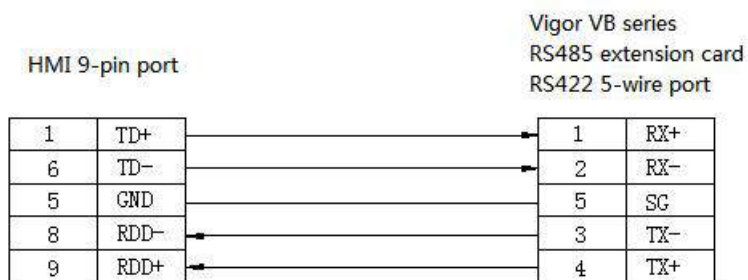

( Fig 3 )

(2) RS485 connection

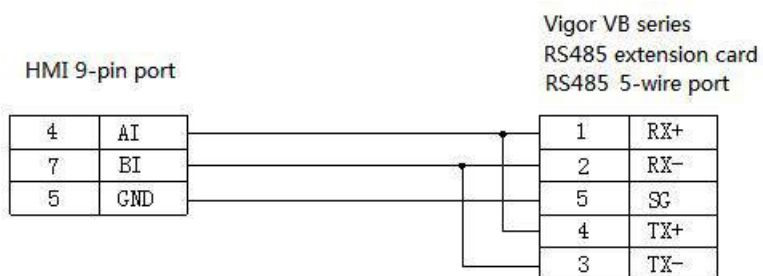

( Fig 4 )

9.1.4 Device address

PLC address type	Range	Object type	Notes
X	0~777	Bit	External input coil
Y	0~777	Bit	External output coil
M	0~9255	Bit	Internal coil
S	0~999	Bit	Internal special step relay
TSTATUS	0~255	Bit	Timer status
CSTATUS	0~255	Bit	Counter status
TCOIL	0~255	Bit	Timer coil
CCOIL	0~255	Bit	Counter coil
C16	0~199	Word	16-bit counter
C32	200~255	DWord	32-bit counter
D	0~9255	Word/ DWord	Data register
TW	0~255	Word/ DWord	Timer
X	0~777	Word/ DWord	Used as a register
Y	0~777	Word/ DWord	Used as a register
M	0~9255	Word/ DWord	Used as a register
S	0~999	Word/ DWord	Used as a register

## 9.2 Vigor VS series

### 9.2.1 Device type

Series	CPU	Connected module	Port	Cable making	PLC model in Touchwin software
VS	VS1/2/M/3	CPU direct connection	RS232	Fig1	Vigor VS series

### 9.2.2 Parameters

#### 1. HMI settings

Parameter	Recommend settings	Choices of settings	Note
PLC type	Vigor VS series		None
Port	RS232	RS232/RS485/RS422	
Data bit	8		
Stop bit	1		
Parity	Even parity		
Baud rate	19200		
Station No.	1		

The default communication parameters for the Vigor VS series protocol are:

Communication settings

Basic info

Device: Vigor VS

Device: Vigor VS

Serial port info

Interfac: RS232

Baud: 19200 Data bit: 8

Parity: Even Stop bit: 1

Station: 0

Timeout and packaging parameters

Communicat: 1000 Retry count: 3

Delay time: 0 Interval time: 3

Max read: 120 Max write: 120

Advanced OK

## 2. PLC settings

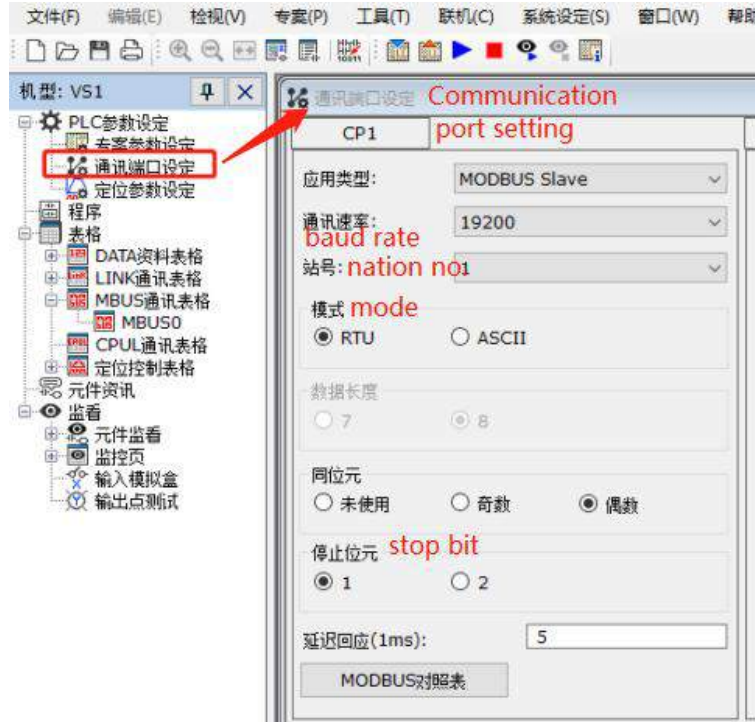

### 9.2.3 Cable making

#### 1. CPU RS232 USB-A:

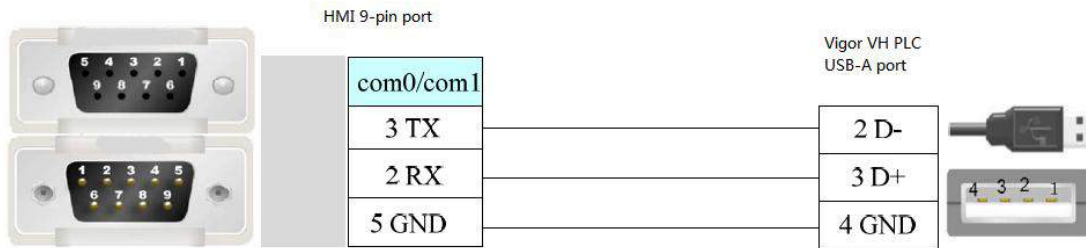

( Fig 1 )

#### 2. CPU direct connection or RS232 extension card:

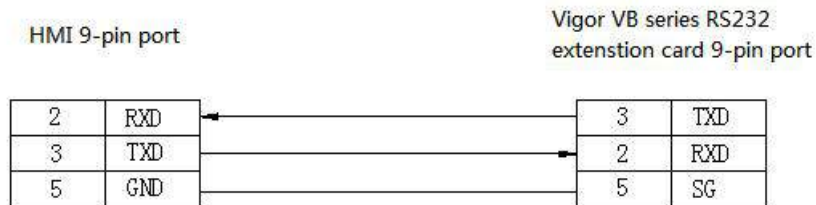

( Fig 2 )

#### 3. CPU direct connection or RS485 extension card:

##### (1) RS422 connection

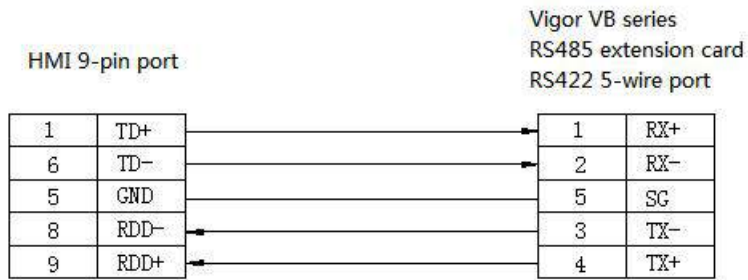

( Fig 3 )

(2) RS485 connection

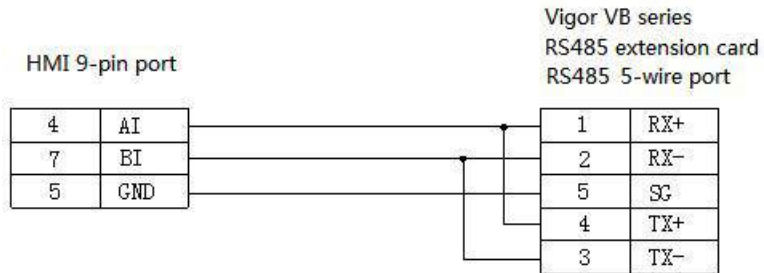

( Fig 4 )

9.2.4 Device address

PLC address type	Range	Object type	Notes
X	0~377	Bit	External input coil
Y	0~377	Bit	External output coil
M	0~8191	Bit	Internal coil
S	0~4095	Bit	Internal special step relay
TSTATUS	0~511	Bit	Timer status
CSTATUS	0~255	Bit	Counter status
TCOIL	0~255	Bit	Timer coil
CCOIL	0~255	Bit	Counter coil
M	9000~9511	Bit	Internal special step relay
C16	0~199	Word	16-bit counter
C32	200~255	DWord	32-bit counter
D	0~8999	Word/ DWord	Data register
T	0~511	Word/ DWord	Timer
C	0~199	Word/ DWord	Used as a register
R	0~23999	Word/ DWord	Used as a register

# 10 Omron PLC Connection Instructions

This chapter mainly introduces the connection instructions between the touch screen and the Omron PLC communication equipment.

**Note:**

- ( 1 )The Xinje TS series touch screen supports a maximum baud rate of 187.5K.
- ( 2 )During communication, please don't plug or unplug cables with power, as it may cause damage to the device's serial port.
- ( 3 )Upgrade of touch screen software version, there may be some changes in the communication protocol device address range. The device address range in the software shall prevail.

## 10.1 Omron CP/CJ/CS series

### 10.1.1 Device type

Series	CPU	Connected module	Port	Cable making	PLC model in Touchwin software
CP	CP1E-30N	CPU direct connection	RS232	Fig1	Omron CP/CJ/CS series
	CP1H	Module CP1W-CIF11	RS485	Fig 2	
	CP1L	Module CP1W-CIF11	RS422	Fig 3	
CJ	CJ1	CPU direct connection	RS232	Fig1	
	CJ1G-CPU44				
	CJ1G-CPU45				
	CJ2M-CPU11				
CS1	CS1H-CPU63/64/65/66/67	CPU direct connection	RS232	Fig1	
	CS1G-CPU42/43/44/45				
	CS1G-CPU42H				
	CS1G-CPU43H				
	CS1G-CPU44H				
	CS1G-CPU45H				
	CS1H-CPU63H				
	CS1H-CPU64H				
	CS1H-CPU65H				
	CS1H-CPU66H				
	CS1H-CPU67H				

### 10.1.2 Parameters

#### 1. HMI settings

Parameter	Recommend settings	Choices of settings	Note
PLC type	Omron CP/CJ/CS series	Omron CP/CJ/CS series	None
Port	RS232	RS232/RS485	
Data bit	7		
Stop bit	2		
Parity	Even parity		
Baud rate	9600	9600/19200/38400/57600/115200	
Station No.	0	0~255	

OMRON PLC CP/CJ/CS and CPM/CQM series protocol default communication parameters:

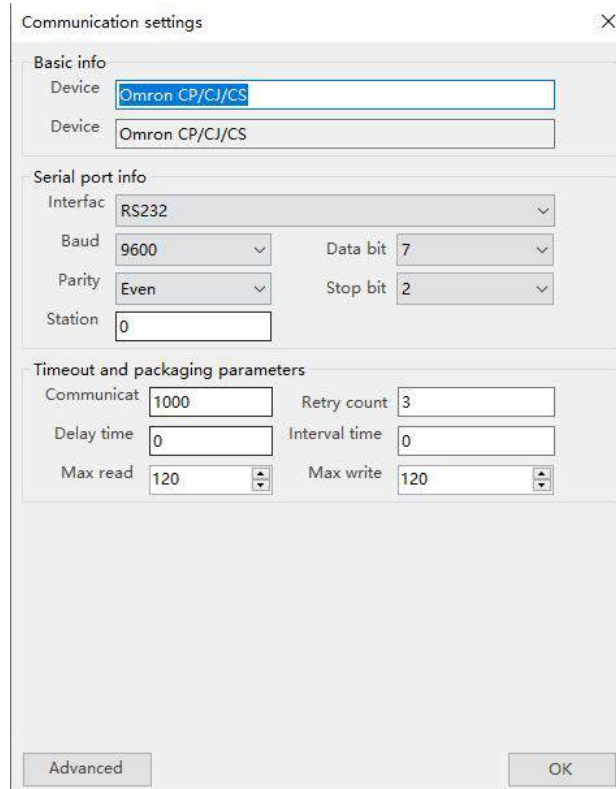

## 2. PLC settings

Taking Omron CP1H as an example, explain the setting of PLC communication parameters as follows:





**Note:**

- ( 1 )Set the PLC startup mode to Monitor in the startup item.
- ( 2 )In the settings of serial port 1, it should be set to HOST LINK. When changing this setting, don't turn off the power.
- ( 3 )When creating the screen, Omron's default station number is 0, not 1.
- ( 4 )Select DIP4 switch as OFF on the PLC body, so that serial port 1 is in the SETUP state.

10.1.3 Cable making

- 1. CPU RS232 port:

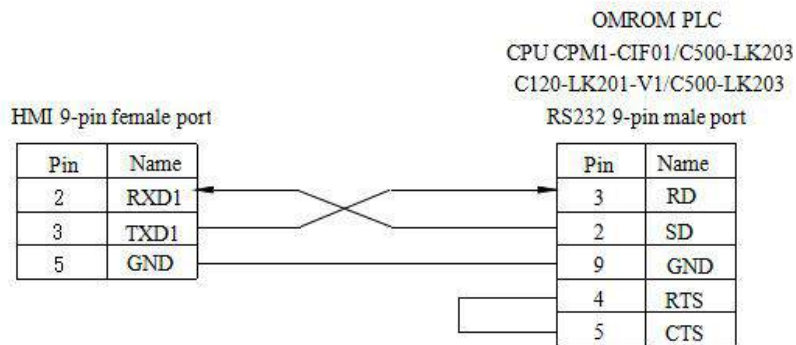

( Fig1 )

- 2. Through module CP1W-CIF11 RS485:

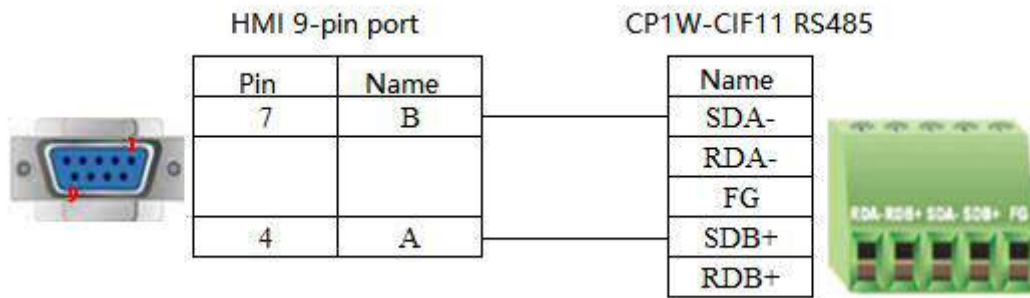

( Fig 2 )

**Note:**

( 1 )When OMRON PLC uses the communication module CPIW-CIF11 for communication, a dial switch can be set to set the communication method:

DIP 1: Selection of terminal resistors: OFF doesn't use terminal resistors, ON uses terminal resistors.

DIP 2: 2-wire or 4-wire selection, OFF 4-wire (RS422), ON 2-wire (RS485), must be consistent with DIP 3 settings.

DIP 3: 2-wire or 4-wire selection, OFF 4-wire (RS422), ON 2-wire (RS485), must be consistent with DIP 2 settings.

DIP 4: Not used.

DIP 5: RS control selection for RD, OFF to disable RS control, ON to enable RS control.

DIP 6: RS control selection for SD, OFF to disable RS control, ON to enable RS control.

Please refer to the OMRON PLC hardware manual for specific instructions.

( 2 )When OMRON PLC uses the communication module CPIW-CIF11 RS485 for communication, DIP 1 can be set to OFF, DIP 2/3/5/6 can be set to ON, and DIP 4 can be set to ON/OFF.

3. Through the module CP1W-CIF11 RS422:

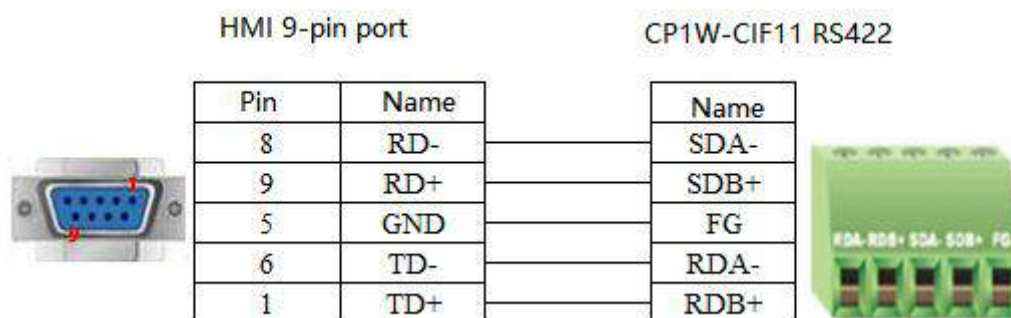

( Fig 3 )

**Note:** When OMRON PLC uses the communication module CPIW-CIF11 RS422 for communication, DIP 1/2/3/5/6 is set to OFF, and DIP 4 can be ON/OFF.

10.1.4 Device address

PLC address type	Range	Object type	Notes
CIO	0.0~9999.15	Bit	Input/output, starting from CIO 100.00 for output
D	0.0~99999.15	Bit	Intermediate relay
H	0.0~9999.15	Bit	Power outage holding relay
W	0.0~9999.15	Bit	Work area relay

---

A	0.0~9999.15	Bit	Auxiliary relay
T	0~9999	Bit	Timer
C	0~9999	Bit	Counter
CIO	0~9999	Word/DWord	Used as a register
D	0~99999	Word/DWord	Data register
H	0~9999	Word/DWord	Power outage hold register
W	0~9999	Word/DWord	Work Area Register
A	0~9999	Word/DWord	Auxiliary register
T	0~9999	Word/DWord	Current value
C	0~9999	Word/DWord	Counter current value

# 11 Inovance PLC Connection Instructions

This chapter mainly introduces the connection instructions between the touch screen and the Inovance PLC communication equipment.

**Note:**

- ( 1 )The Xinje TS series touch screen supports a maximum baud rate of 187.5K.
- ( 2 )During communication, please don't plug or unplug cables with power, as it may cause damage to the device's serial port.
- ( 3 )Upgrade of touch screen software version, there may be some changes in the communication protocol device address range. The device address range in the software shall prevail.

## 11.1 Inovance H1U/H2U series

### 11.1.1 Device type

Series	CPU	Connected module	Port	Cable making	PLC model in Touchwin software
H1U	H1U-0806MR/T	CPU	RS422	Fig1	Mitsubishi FX series
	H1U-1410MR/T		RS485	Fig 2	
H2U	H1U-1614MR/T		RS422	Fig1	
	H2U-1616MR/T		RS485	Fig 2	
	H2U-2416MR/T				
	H2U-3624MR/T				

### 11.1.2 Parameters

#### 1. HMI settings

Parameter	Recommend settings	Choices of settings	Note
PLC type	Mitsubishi FX series	Mitsubishi FX series / MODBUS RTU ( HMI is Master ) / MODBUS ASCII ( HMI is Master )	None
Data bit	7		
Stop bit	1		
Parity	Even parity		
Baud rate	9600		
Station No.	0		

The Inovance H1U/2U series PLC uses the Mitsubishi FX series protocol with default communication parameters:

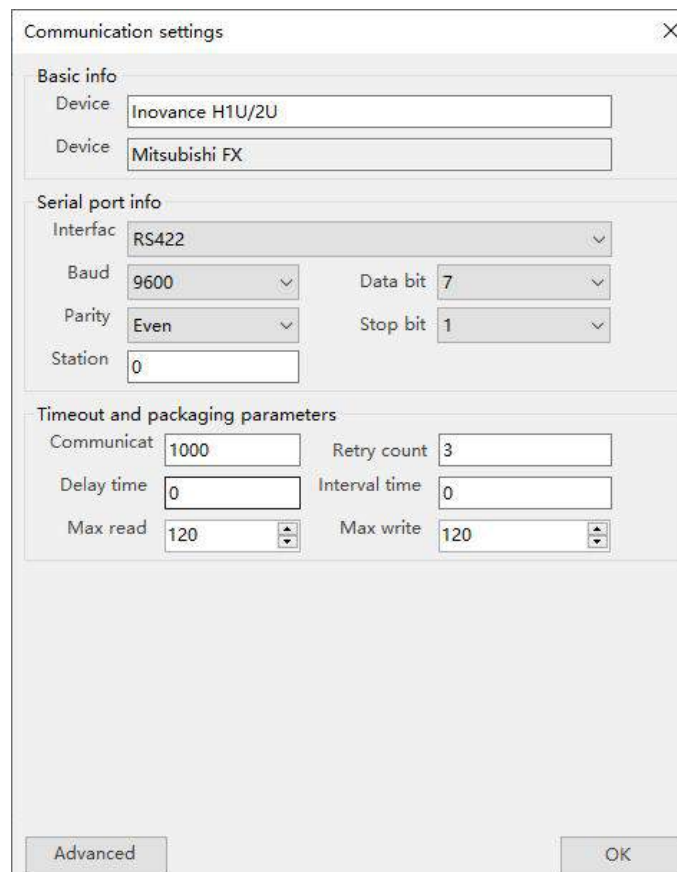

## 2. PLC settings

### (1) COM0



**Note: Short circuiting JP0 represents using COM0 RS422 (mini DIN8 circular female socket) Short circuit JP0, set D8116 to H01 in the program, download the program, then disconnect JP0 and power on again, representing the use of COM0 RS485 (screw terminal).**

### (2) COM1



**Note: Short circuit JP0 and set D8126 to 1 in the PLC program. Download the program to represent the use of COM1 RS485 (screw terminal).**

### 11.1.3 Cable making

1. H1U/2U series PLC RS422 port:

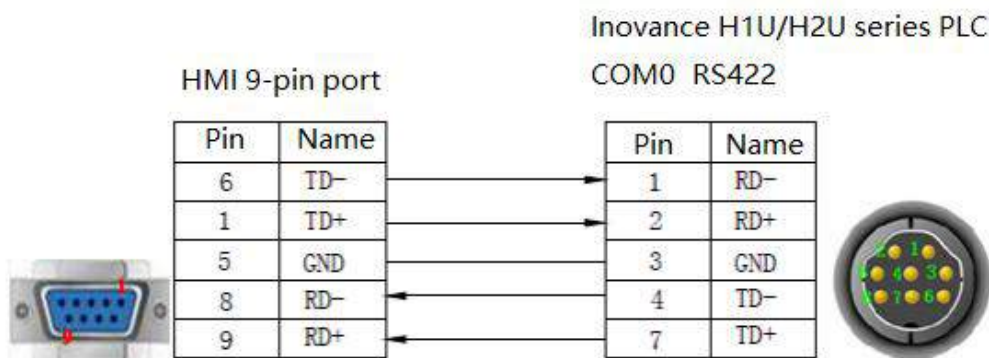

( Fig1 )

2. H1U/2U series PLC RS485 port:

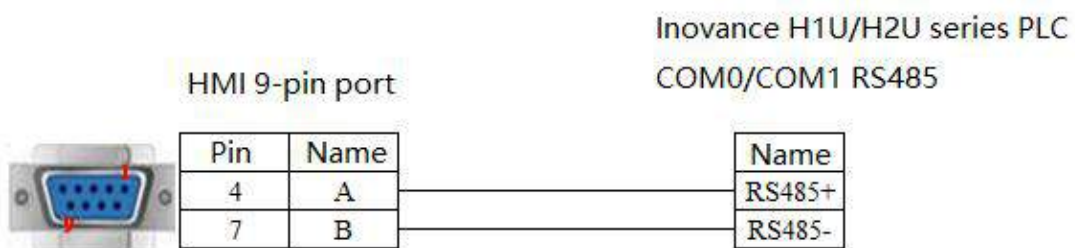

( Fig 2 )

### 11.1.4 Device address

PLC address type	Range	Object type	Notes
X	0~177	Bit	External input coil
Y	0~177	Bit	External output coil
M	0~8255	Bit	Internal coil
S	0~999	Bit	Stepper coil

---

T	0~255	Bit	Timer
C	0~255	Bit	Counter
C16	0~199	Word/DWord	16-bit counter
C32	200~255	DWord	32-bit counter
D	0~8255	Word/DWord	Data register
T	0~255	Word/DWord	Timer
X	0~177	Word/DWord	Data register
Y	0~177	Word/DWord	Data register
M	0~8255	Word/DWord	Data register
S	0~999	Word/DWord	Data register

## 11.2 Inovance H3U series

### 11.2.1 Device type

Series	CPU	Connected module	Port	Cable making	PLC model in Touchwin software
H3U	H3U-3232MR/T H3U-3624MR/T H3U-1616MR/T-XP H3U-2416MR/T-XP	CPU	RS422	Fig1	Inovance H3U( ModbusRTU )
			RS485	Fig 2	

### 11.2.2 Parameters

#### HMI settings

Parameter	Recommend settings	Choices of settings	Note
PLC type	Inovance H3U ( Modbus RTU )	Inovance H3U ( ModbusRTU ) / MODBUS RTU ( HMI is Master )	None
Data bit	7		
Stop bit	1		
Parity	Even parity		
Baud rate	9600		
Station No.	0		

The default communication parameters for the Inovance H3U series PLC protocol are:

Communication settings

Basic info

Device: INOVANCE H3U (Modbus RTU)

Device: INOVANCE H3U (Modbus RTU)

Serial port info

Interfac: RS232

Baud: 19200 Data bit: 8

Parity: Even Stop bit: 1

Station: 1

Timeout and packaging parameters

Communicat: 1000 Retry count: 3

Delay time: 0 Interval time: 0

Max read: 120 Max write: 120

Advanced OK

### 11.2.3 Cable making

#### 1. H3U series PLC RS422 port:

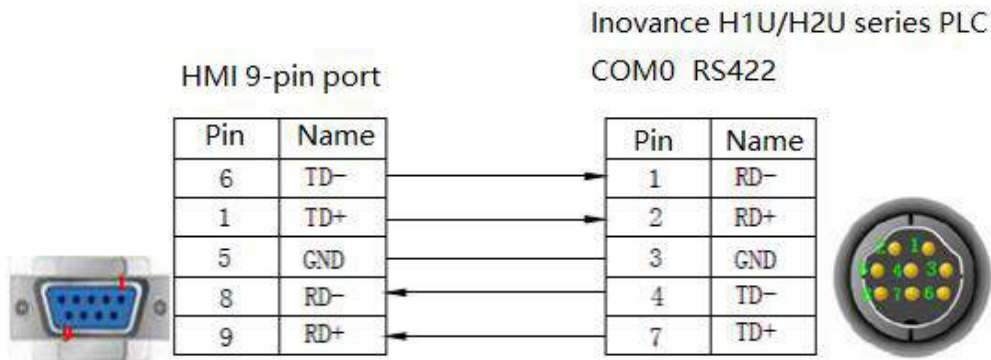

( Fig1 )

#### 2. H3U series PLC RS485 port:

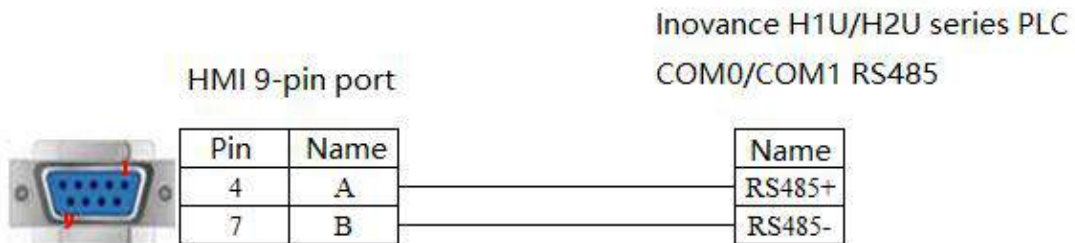

( Fig 2 )

### 11.2.4 Device address

PLC address type	Range	Object type	Notes
X	0~255	Bit	External input coil
Y	0~255	Bit	External output coil
M	0~7679	Bit	Internal coil
M8xxx	0~511	Bit	Special relay
S	0~4095	Bit	Status relay
SM	0~1023	Bit	System relay
T	0~511	Bit	Timer
C	0~255	Bit	Counter
D	0~8511	Word/DWord	Data register
SD	0~1023	Word/DWord	System memory
R	0~32767	Word/DWord	File memory
C16	0~199	Word/DWord	16-bit counter
C32	200~255	DWord	32-bit counter
T	0~511	Word/DWord	Timer

## 11.3 Inovance H5U series

### 11.3.1 Device type

Series	CPU	Connected module	Port	Cable making	PLC model in Touchwin software
H5U	H5U-1614MTD H5U-1614MTD-A16 H5U-1614MTD-A8 H5U-1614MTD-A8S	CPU	RS485	Fig1	Inovance H5U( ModbusRTU )

### 11.3.2 Parameters

#### 1. HMI settings

Parameter	Recommend settings	Choices of settings	Note
PLC type	Inovance H5U ( Modbus RTU )	Inovance H5U ( ModbusRTU ) / MODBUS RTU ( HMI is Master )	None
Data bit	7		
Stop bit	1		
Parity	Even parity		
Baud rate	9600		
Station No.	0		

The Inovance H5U series PLC uses the Inovance H5U (ModbusRTU) protocol with default communication parameters:

### 11.3.3 Cable making

#### 1. H5U series PLC RS485 port:

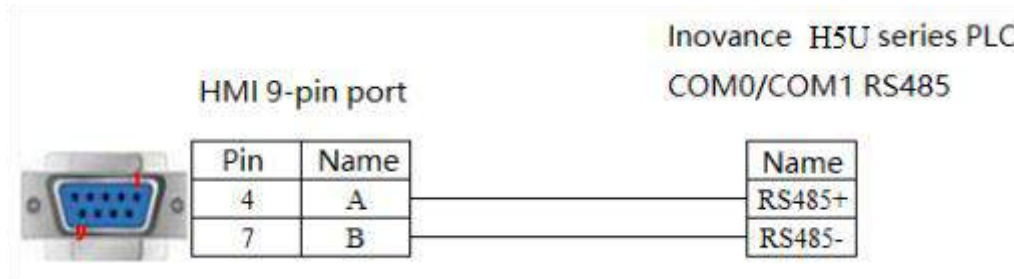

( Fig1 )

### 11.3.4 Device address

PLC address type	Range	Object type	Notes
M	0~7999	Bit	Internal coil
B	0~32768	Bit	Expansion relay
S	0~4095	Bit	Stepper coil
X	0~1777	Bit	External input coil
Y	0~1777	Bit	External output coil
D	0~8000	Word/DWord	Data register
R	0~32768	Word/DWord	Special memory

## 11.4 Inovance AM600 series

### 11.4.1 Device type

Series	CPU	Connected module	Port	Cable making	PLC model in Touchwin software
AM600	AM600	CPU	RS485	Fig1	Inovance AM600

### 11.4.2 Parameters

#### 1. HMI settings

Parameter	Recommend settings	Choices of settings	Note
PLC type	Inovance AM600 series	Inovance AM600 series / MODBUS RTU ( HMI is Master ) / MODBUS ASCII ( HMI is Master )	None
Data bit	8		
Stop bit	1		
Parity	Even parity		
Baud rate	19200		
Station No.	1		

Communication parameters:

Communication settings

Basic info

Device: INOVANCE AM600

Device: INOVANCE AM600

Serial port info

Interfac: RS232

Baud: 19200 Data bit: 8

Parity: Even Stop bit: 1

Station: 1

Timeout and packaging parameters

Communicat: 1000 Retry count: 3

Delay time: 0 Interval time: 0

Max read: 120 Max write: 120

Advanced OK

## 2. PLC settings

### (1) Serial protocol settings

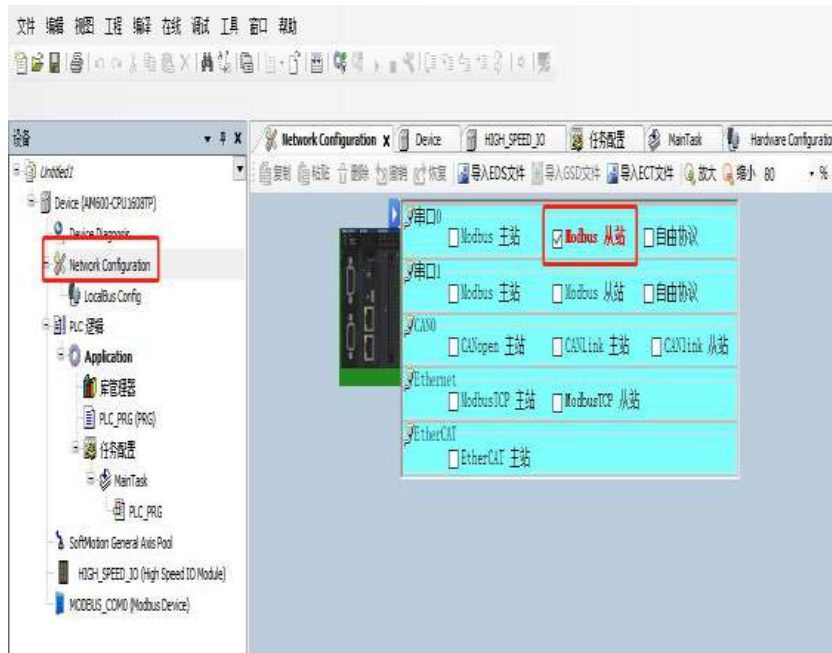

### (2) Communication parameter settings

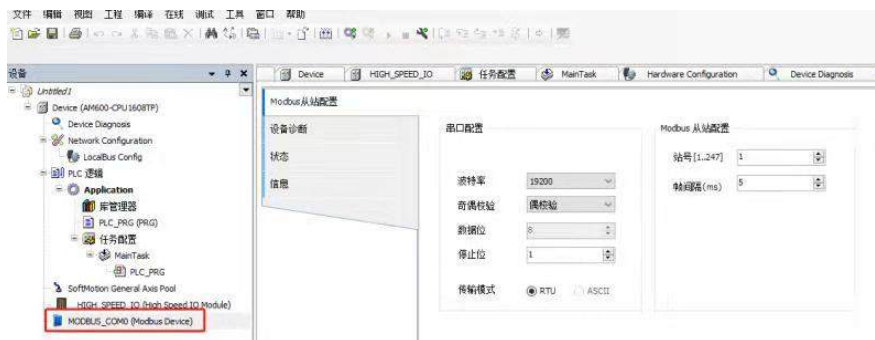

### 11.4.3 Cable making

AM600 series PLC RS485 port:



( Fig1 )

**Note:** If serial port 1 485 is used for communication with pins 1 and 2, and serial port 1 485 is used for communication with pins 6 and 9.

### 11.4.4 Device address

PLC address type	Range	Object type	Notes
I	0~8191	Bit	External input coil

---

Q	0~8191	Bit	External output coil
M	0~65535	Word/DWord	Data register
SM	0~7999	BIT	System variable
SD	0~7999	Word/DWord	Register variable

## 11.5 Inovance AM600 series Ethernet

### 11.5.1 Device type

Series	CPU	Connected module	Port	Cable making	PLC model in Touchwin software
AM600	AM600	CPU	RJ45	Fig1	Inovance AM600 series Ethernet

### 11.5.2 Parameters

#### 1. PLC settings :

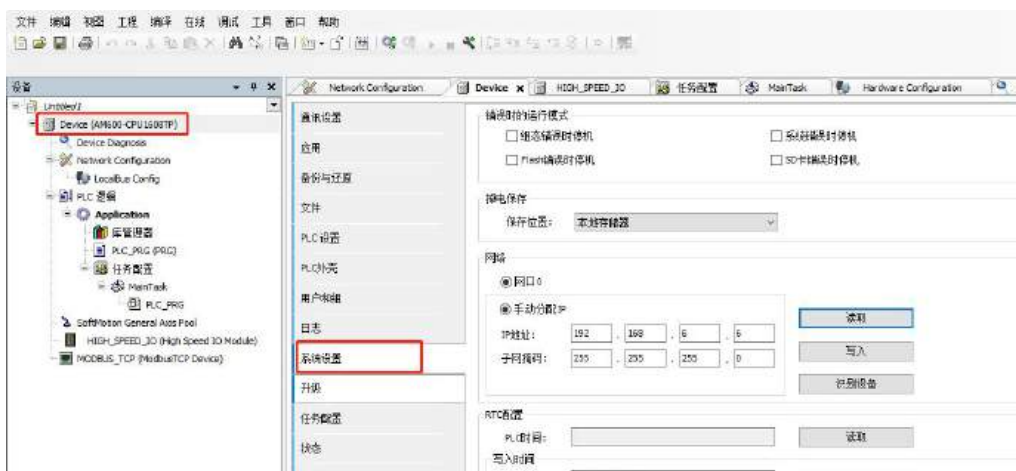
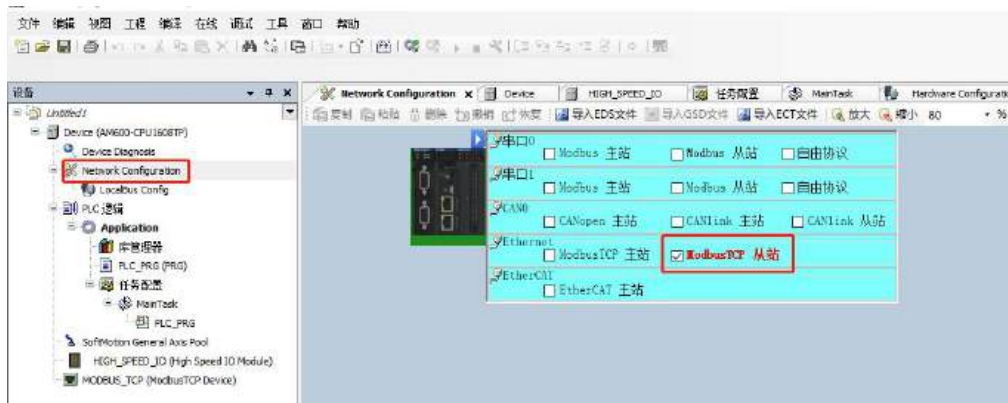

#### 2. HMI settings

- (1) After selecting the human-machine interface model as - E, click to proceed to the next step, select "Net1" in the device list, and set the IP address used for the human-machine interface in "Set Local IP", as long as it doesn't conflict with other IPs in the network.

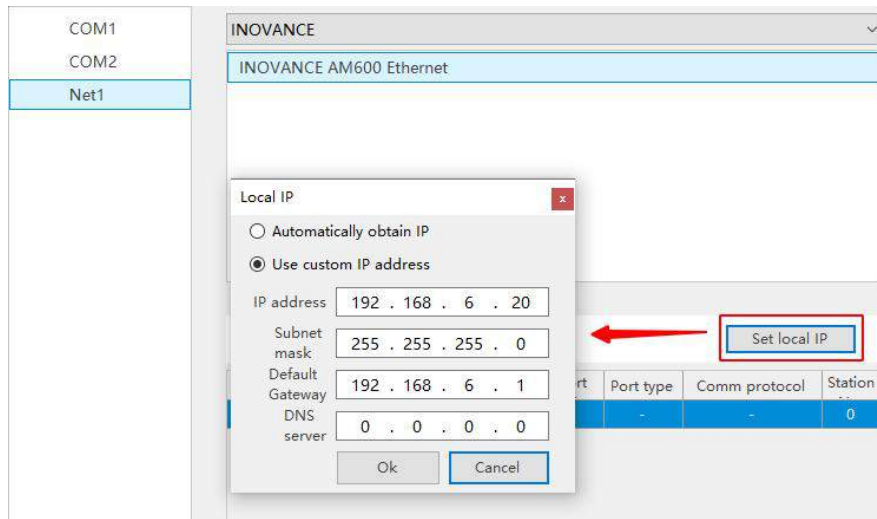

- (2) Select "Net1", click the drop-down button, and select "Innovation" from the brand list:

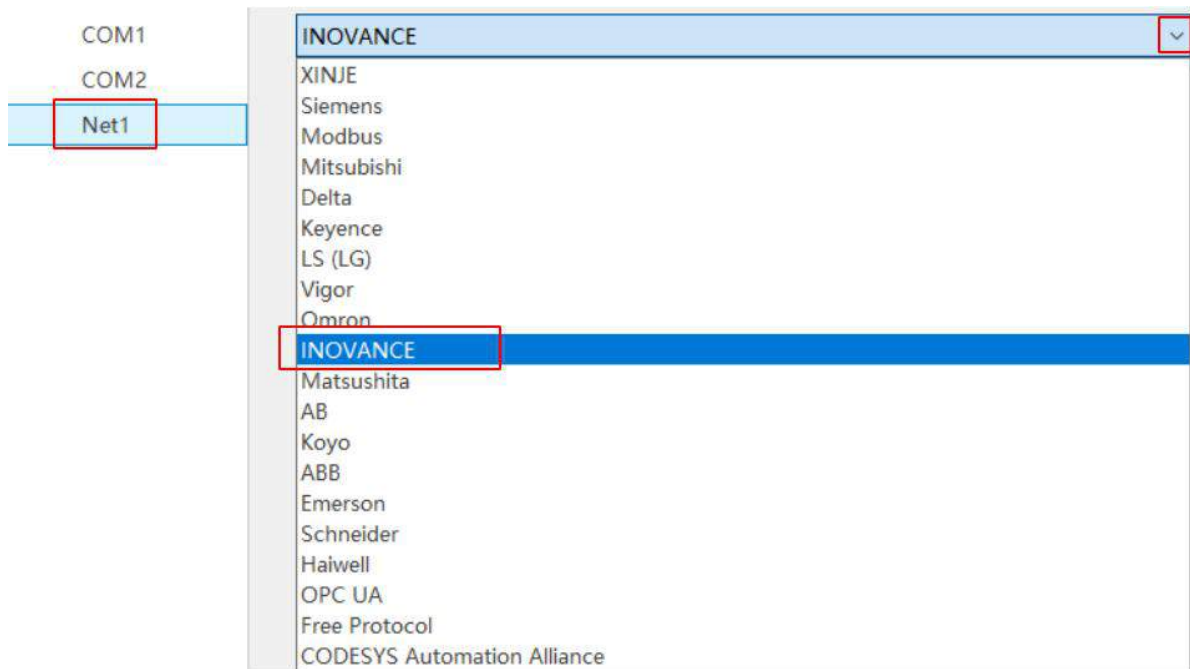

- (3) Click on "Inovance AM600 series Ethernet" in the model list, then select "New Device" and set the communication parameters in the pop-up communication settings window. This IP address is the IP address of the Inovance AM600 series PLC (which can be set through PLC software), and the port number is the "Local Port Number" (decimal) set in the PLC software. After setting up, click "Confirm".

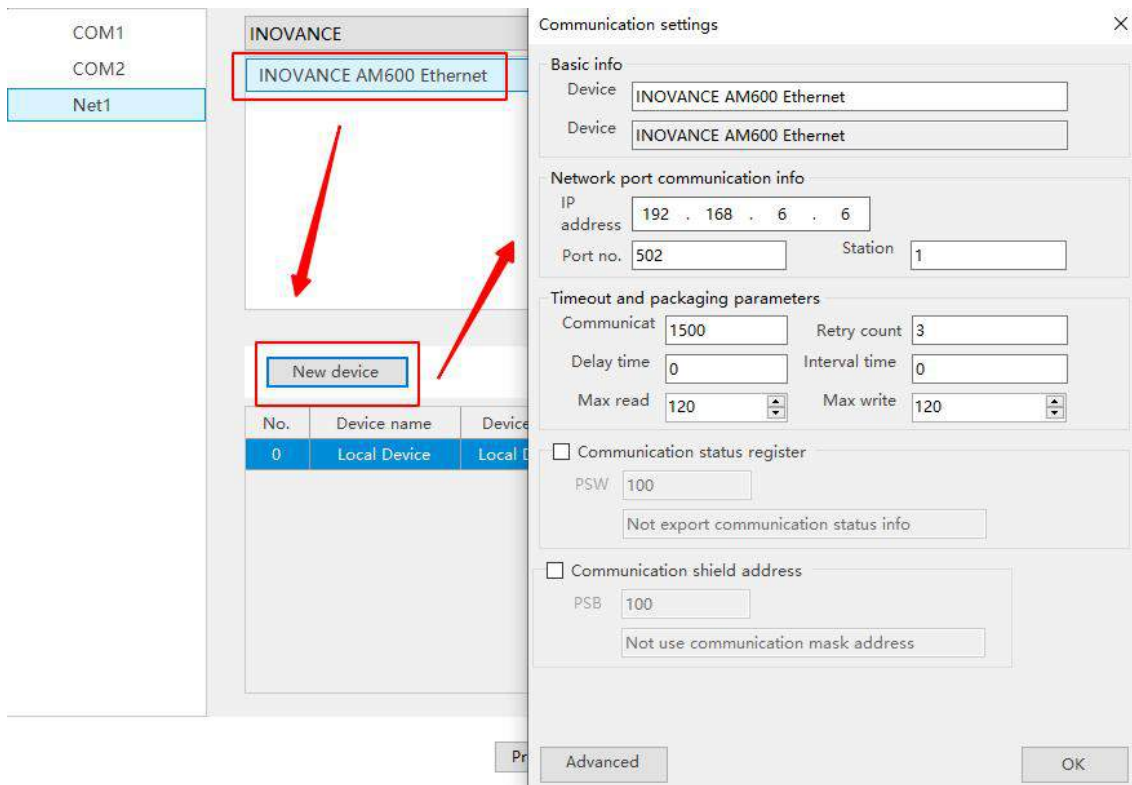

- (4) Check the "Communication Status Register", set PSW to 100, and select PSW100~PSW103 as the communication success number, communication failure number, communication timeout number, and communication error number. Customers can set this communication status address themselves.



- (5) After setting up, click "OK" to end the setup and enter the screen editing interface. Place a data External input coil component on the screen and select it from the device drop-down bar, select the corresponding device "Inovance AM600 Series":

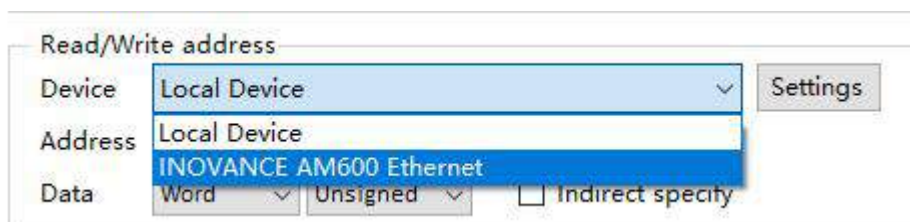

### 11.5.3 Cable making

AS200/300 series PLC RJ45 :

Pin no.	Color		Pin no.	Color
1	White orange	—————	1	White green
2	orange	—————	2	Green
3	White green	—————	3	White orange
4	blue	—————	4	blue
5	White blue	—————	5	White blue
6	Green	—————	6	orange
7	White brown	—————	7	White brown
8	Brown	—————	8	Brown

( Fig1 )

#### 11.5.4 Device address

PLC address type	Range	Object type	Notes
I	0~8191	Bit	External input coil
Q	0~8191	Bit	External output coil
M	0~65535	Word/DWord	Data register
SM	0~255	Bit	System variable
SD	0~7999	Word/DWord	Register variable

# 12 Fatek PLC Connection Instructions

This chapter mainly introduces the connection instructions between the touch screen and the communication equipment of Fatek PLC.

**Note:**

- ( 1 )The Xinje TS series touch screen supports a maximum baud rate of 187.5K.
- ( 2 )During communication, please don't plug or unplug cables with power, as it may cause damage to the device's serial port.
- ( 3 )Upgrade of touch screen software version, there may be some changes in the communication protocol device address range. The device address range in the software shall prevail.

## 12.1 Fatek MU/MA series

### 12.1.1 Device type

Series	CPU	Connected module	Port	Cable making	PLC model in Touchwin software
FBs B1	FBs-20MN FBs-32MN FBs-44MN B1-10/14/20/24M	CPU direct connection	RS232	Fig1	Fatek MU/MA series
			RS485	Fig 2	
FB -MC	20MC 28MC 40MC 19MCT 26MCT 36MCT		RS232	Fig1	
			RS485	Fig 2	
FB -MA	20MA 28MA 40MA	FB-DTBR/DTBR-E module	RS232	Fig 3	
			RS232	Fig 4	
			RS485	Fig 5	

**Note:** The MA series PLC communication requires the configuration of FB-DTBR or FB-DTBR-E communication modules, using RS232 or RS485 connection methods.

### 12.1.2 Parameters

#### 1. HMI settings

Parameter	Recommend settings	Choices of settings	Note
PLC type	Fatek MU/MA series		None
Port	RS232	RS232/RS485	
Data bit	7		
Stop bit	1		
Parity	Even parity		
Baud rate	9600		
Station No.	1	0~255	

Default communication parameters for Fatek MU/MA protocol:

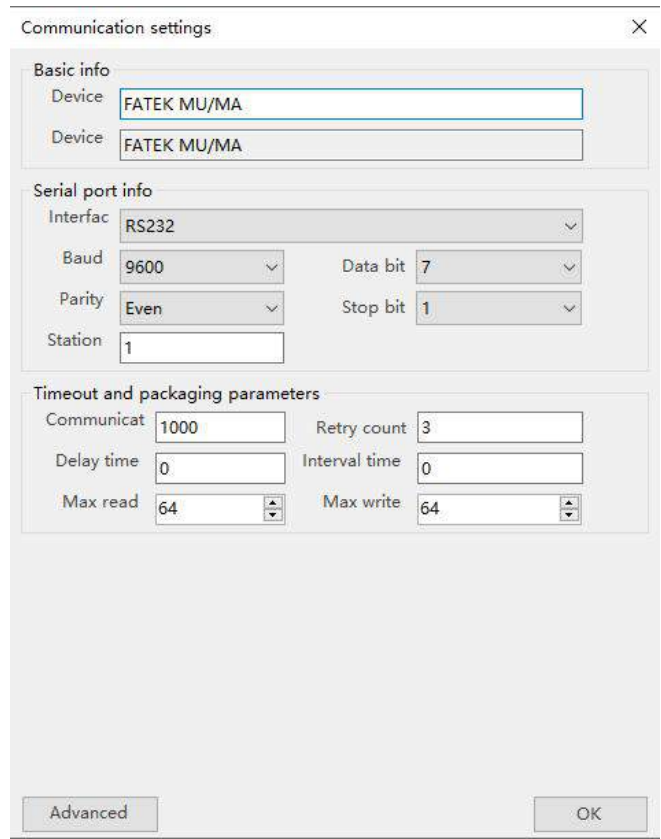

### 12.1.3 Cable making

#### 1. FBs Port0 RS232:

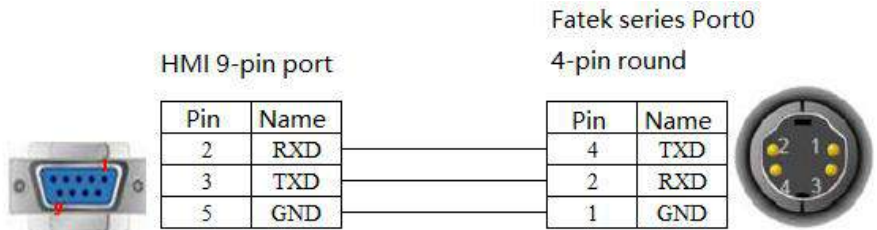

#### CPU Port:

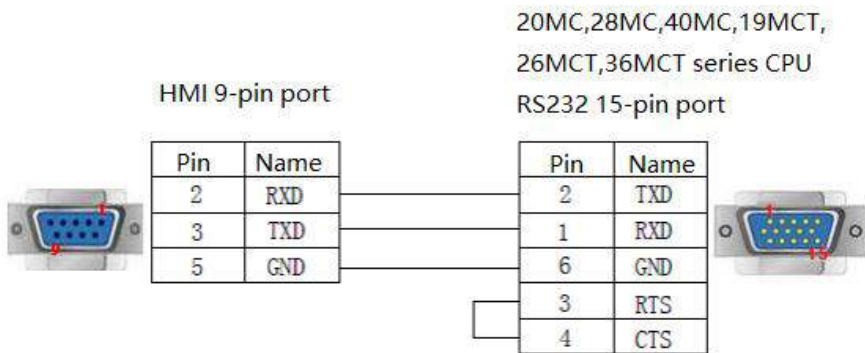

( Fig1 )

2. CPU RS485 :

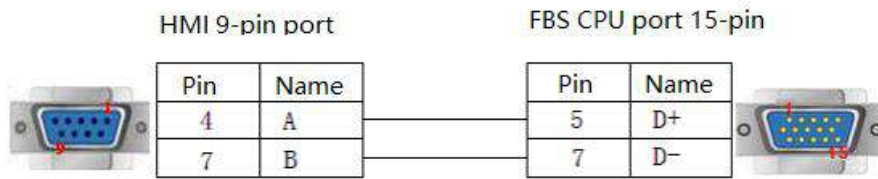

( Fig 2 )

3. FB-DTBR/DTBR-E module RS232:

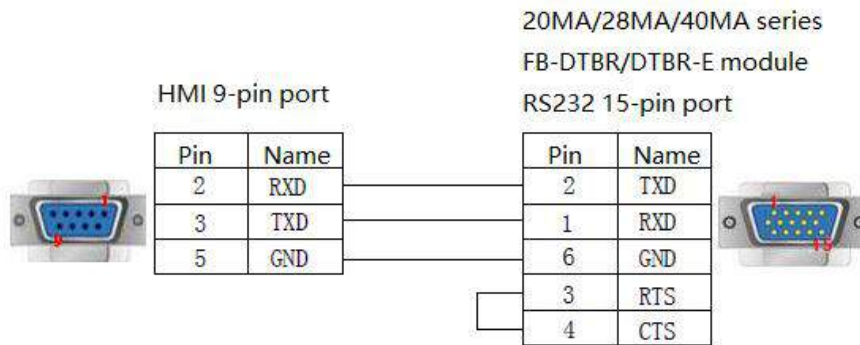

( Fig 3 )

4. FB-DTBR/DTBR-E module RS232 :

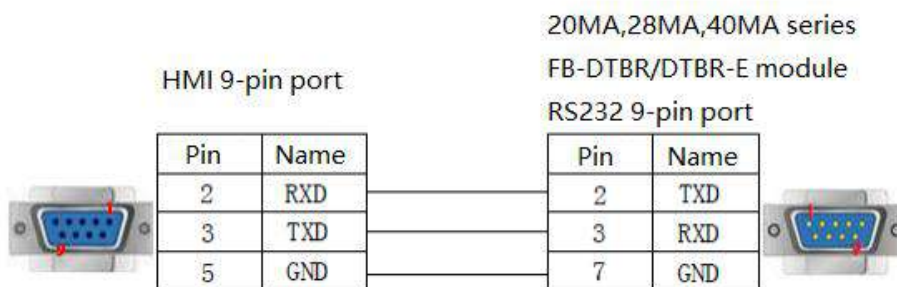

( Fig 4 )

5. FB-DTBR/DTBR-E RS485:

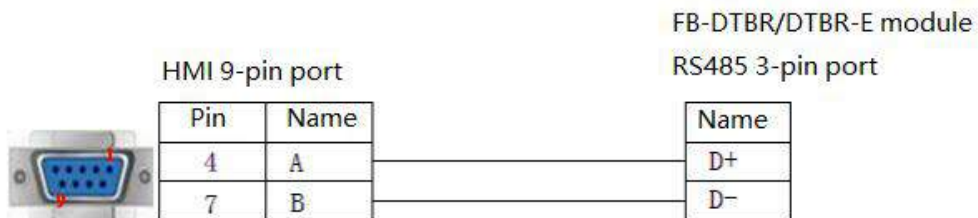

( Fig 5 )

12.1.4 Device address

PLC address type	Range	Object type	Notes
M	0~2001	Bit	Internal coil
X	0~255	Bit	External input coil

---

Y	0~255	Bit	External output coil
S	0~999	Bit	Sequence control relay
T	0~255	Bit	Timer
C	0~255	Bit	Counter
R	0~9000	Word/Dword	Data register
X	0~255	Word/Dword	Used as a register
Y	0~255	Word/Dword	Used as a register
M	0~2001	Word/Dword	Used as a register
S	0~999	Word/Dword	Used as a register
D	0~3071	Word/Dword	Used as a register
TD	0~255	Word/Dword	Current value
C16	0~199	Word	16-bit counter
C32	200~255	Dword	32-bit counter

# 13 Panasonic PLC Connection Instructions

This chapter mainly introduces the connection instructions between the touch screen and Panasonic PLC communication equipment.

**Note:**

- ( 1 )The Xinje TS series touch screen supports a maximum baud rate of 187.5K.
- ( 2 )During communication, please don't plug or unplug cables with power, as it may cause damage to the device's serial port.
- ( 3 )Upgrade of touch screen software version, there may be some changes in the communication protocol device address range. The device address range in the software shall prevail.

## 13.1 Panasonic FP0/FP1 series

### 13.1.1 Device type

The Matsushita Newnet FP series PLC includes models such as FP0, FP1, FP3, FP2SF, FP10SH, etc. It can be connected to the Xinje touch screen through the programming port or communication port on its CPU. The FP0-CXXCXX models in the FP0 series only support RS232 connection.

Series	CPU	Connected module	Port	Cable making	PLC model in Touchwin software
FP	FP $\Sigma$	CPU direct connection	RS232	Fig1	Panasonic FP0/FP1 series
	FP0				
	FP0R-C32CT				
	FPG				
	FP-X				
	FP-M	CPU direct connection	RS232	Fig1	
	FP-E				
	FP2	CPURS232 port	RS232	Fig 2	
	FP2SH	CPURS422 port	RS422	Fig 3	
	FP1	CPURS422 port	RS422	Fig 4	
FP3	CPURS232port	RS232	Fig 2		
FP10SH					
FP10S					

### 13.1.2 Parameters

#### 1. HMI settings

Parameter	Recommend settings	Choices of settings	Note
PLC type	Panasonic FP0/FP1 series		None
Port	RS232	RS232/RS422	
Data bit	8		
Stop bit	1		
Parity	Odd parity		
Baud rate	9600	9600/19200/38400/57600/115200	
Station No.	1	0~255	

Panasonic FP0/FP1 protocol default communication parameters:

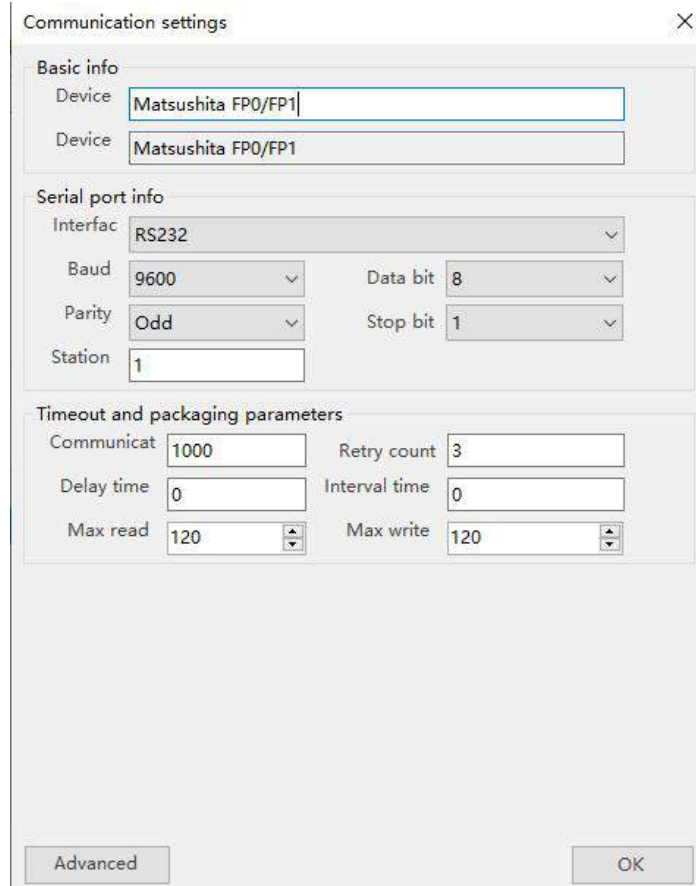

2. PLC settings

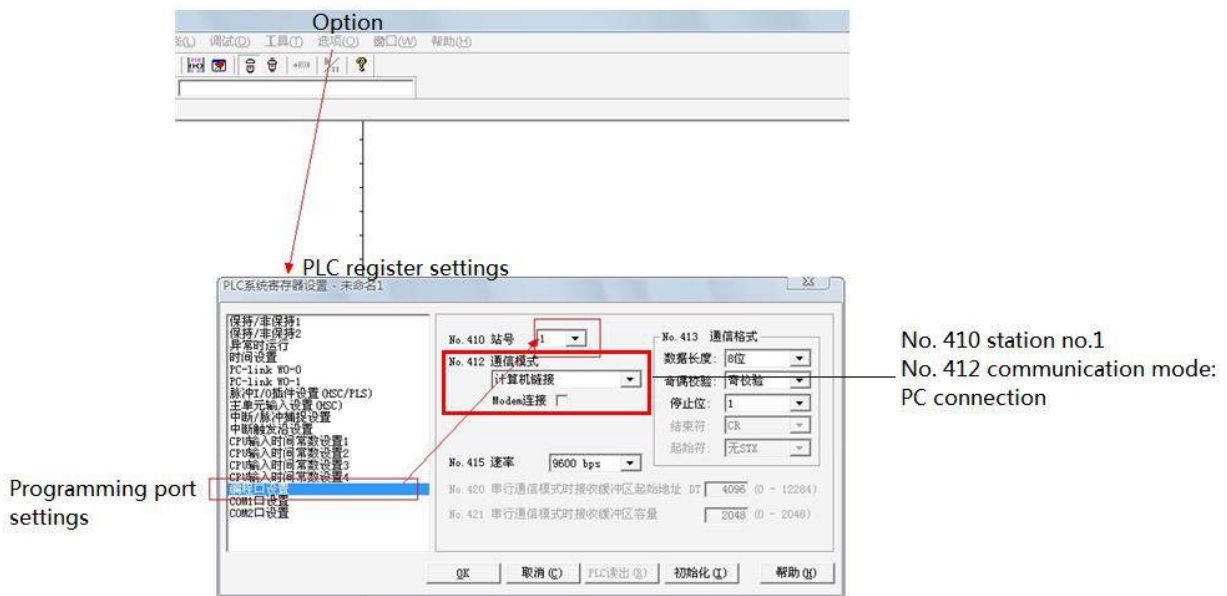

**Note:**

( 1 ) PLC software component input method.

LC	屏
R45	R 4 5
Y1	Y 0 1

( 2 )When writing PLC programs, turn the dial switch to the PPOG state. During communication, the dial switch is set to the Run state.

( 3 )Set the PLC station number and communication parameters, and don't choose<Universal Communication Method>, otherwise it will cause abnormal communication.

( 4 )The default station number for the FP series PLC is 1, but the FP3 model must be set to 0.

### 13.1.3 Cable making

#### 1. CPU 5-pin port:

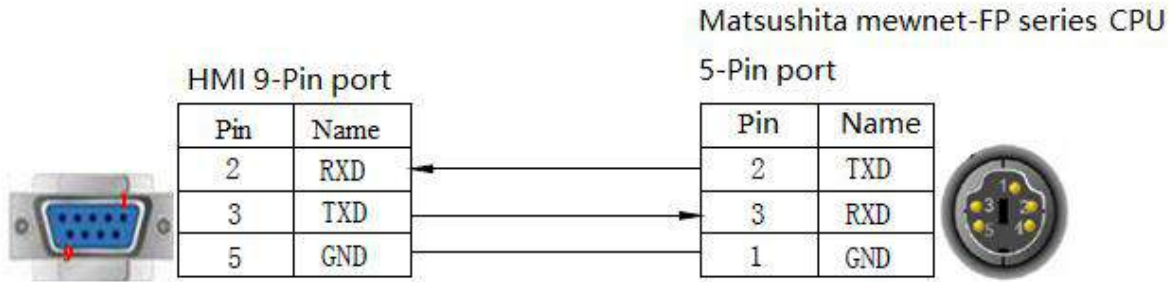

( Fig1 )

#### 2. CPU RS232 9-pin port

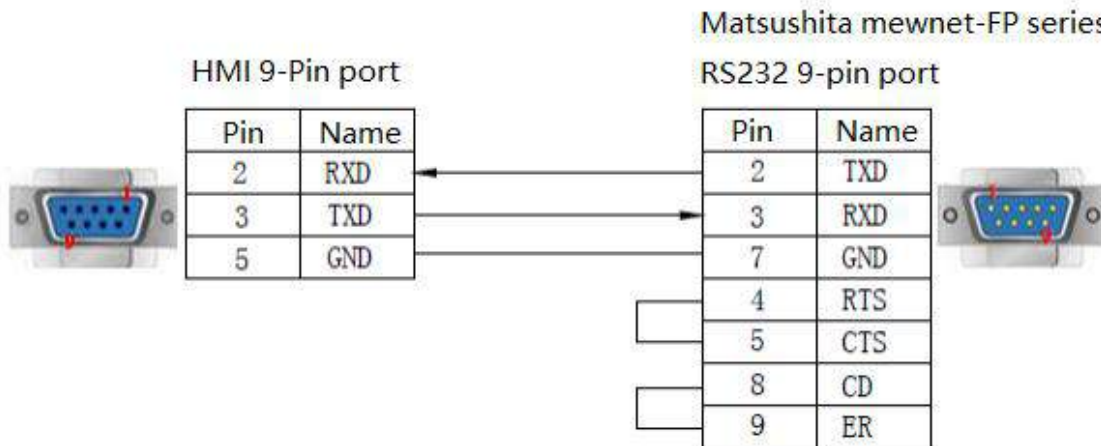

( Fig 2 )

#### 3. CPU RS422 8-pin port

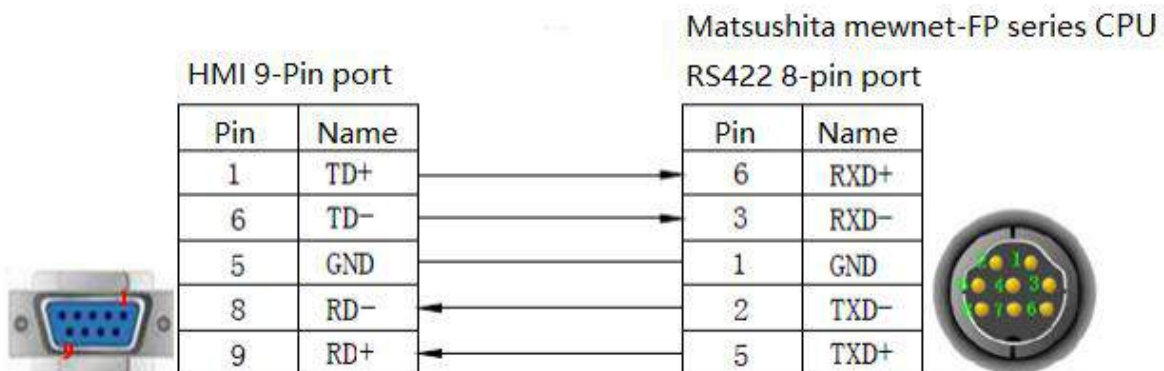

( Fig 3 )

4. CPU RS422 15-pin port:

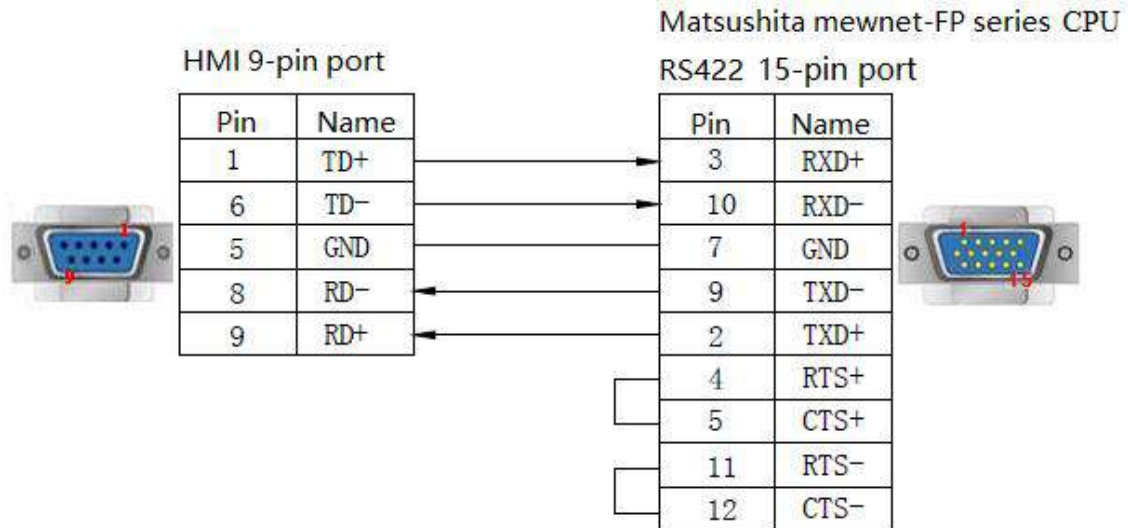

( Fig 4 )

13.1.4 Device address

PLC address type	Range	Object type	Notes
X	0.0~12.F	Bit	External input coil (Bit operation)
Y	0.0~12.F	Bit	External output coil (Bit operation)
R	0.0~65535.F	Bit	Internal coil (Bit operation)
T	0~99	Bit	Timer
L	0.0~65535.F	Bit	Connect control relay
C	1008~9999	Bit	Counter
WX	0~9999	Word/DWord	Single word/Double word register
WY	0~9999	Word/DWord	Single word/Double word register
WR	0~9999	Word/DWord	Single word/Double word register
FL	0~65535	Word/DWord	Connect Control Register
SV	0~143	Word/DWord	Timer or counter set value register
EV	0~143	Word/DWord	Timer or counter actual value register
DT	0~65535	Word/DWord	Single word/Double word data register

## 13.2 Panasonic FP-XH series

### 13.2.1 Device type

Series	CPU	Connected module	Port	Cable making	PLC model in Touchwin software
FP	FP-XH	CPU direct connection	RS232	Fig1	Panasonic FP-XH series

### 13.2.2 Parameters

#### 1. HMI settings

Parameter	Recommend settings	Choices of settings	Note
PLC type	Panasonic FP-XH series		None
Port	RS232	RS232/RS422	
Data bit	8		
Stop bit	1		
Parity	Odd parity		
Baud rate	9600	9600/19200/38400/57600/115200	
Station No.	1	0~255	

Panasonic FP0/FP1 protocol default communication parameters:

Communication settings

Basic info

Device: Matsushita FP-XH

Device: Matsushita FP-XH

Serial port info

Interfac: RS232

Baud: 9600 Data bit: 8

Parity: Odd Stop bit: 1

Station: 1

Timeout and packaging parameters

Communicat: 1000 Retry count: 3

Delay time: 0 Interval time: 0

Max read: 120 Max write: 120

Advanced OK

#### 2. PLC settings

Select Modbus RTU for PLC communication mode and set communication parameters consistent with the touch screen.

### 13.2.3 Cable making

#### 1. CPU 5-pin port:

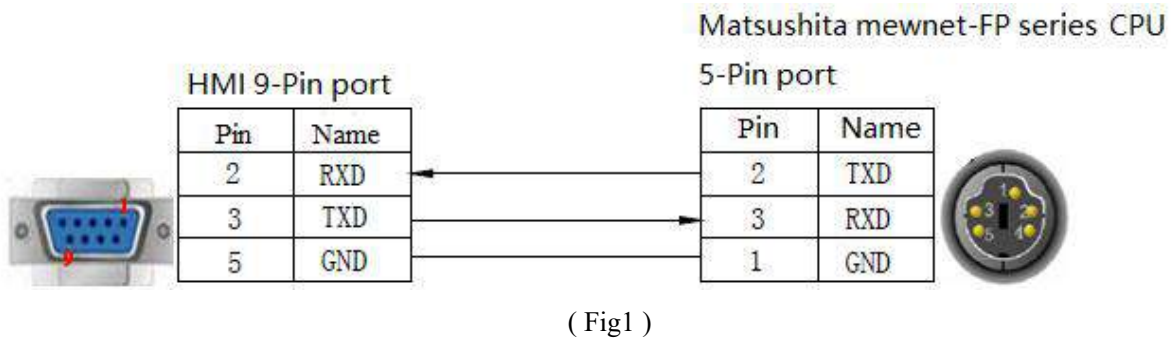

#### 2. CPU RS232 9-pin port:

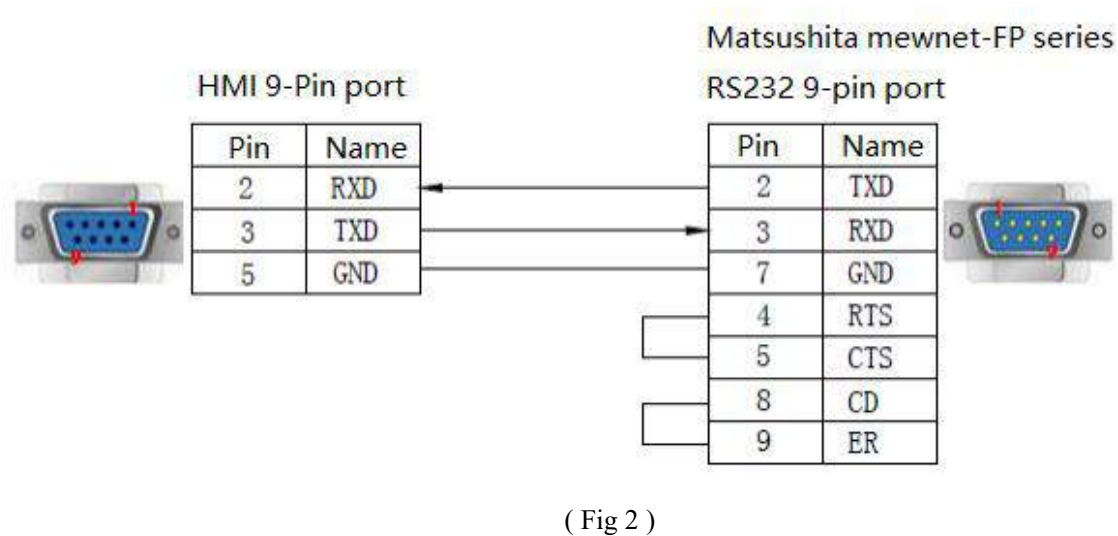

#### 3. CPU RS422 8-pin port:

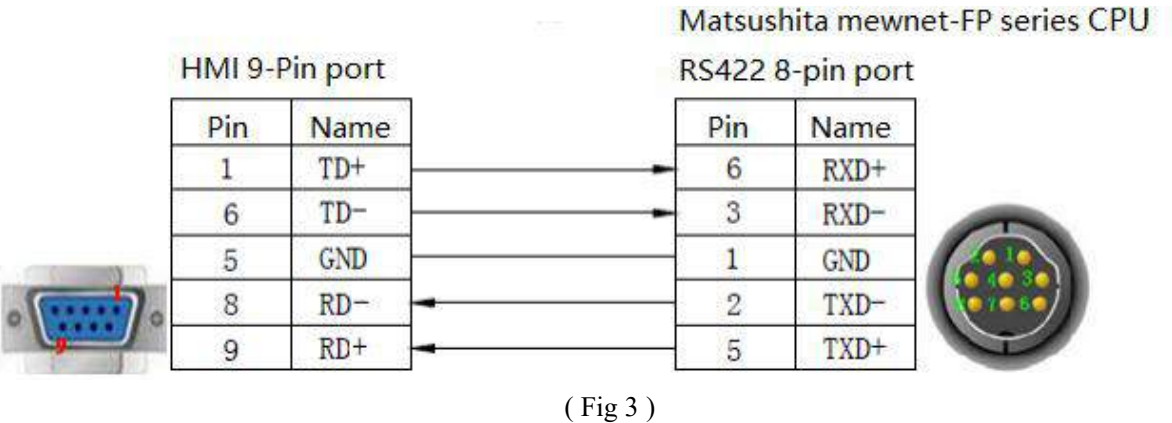

### 13.2.4 Device address

PLC address type	Range	Object type	Notes
X	0~109	Bit	External input coil (Bit operation)
Y	0~109	Bit	External output coil (Bit operation)
R	0~511	Bit	Internal coil (Bit operation)
DT	0~65532	Word/DWord	Holding register
WL	0~127	Word/DWord	Input register
LD	0~255	Word/DWord	Input register

# 14 AB PLC Connection Instructions

This chapter mainly introduces the connection instructions between the touch screen and AB PLC communication equipment.

**Note:**

- ( 1 )The Xinje TS series touch screen supports a maximum baud rate of 187.5K.
- ( 2 )During communication, please don't plug or unplug cables with power, as it may cause damage to the device's serial port.
- ( 3 )Upgrade of touch screen software version, there may be some changes in the communication protocol device address range. The device address range in the software shall prevail.

## 14.1 AB Micrologix/SLC series

### 14.1.1 Device type

Series	CPU	Connected module	Port	Cable making	PLC model in Touchwin software
Micrologix	Micrologix1000 Micrologix1200 Micrologix1500 ( 1762-L40BWA ) ( 1764-LSP,1764-LRP )	CPU RS232port	RS232	Fig1	AB Micrologix/SLC series (DF1 Full Duplex)
	Micrologix1400 ( 1766-L32BWAA )				
	Micrologix1500 ( 1764-LRP )				
	1761-L1613WA				
SLC 500	SLC5/03 SLC5/04 SLC5/05	CPU RS232port	RS232	Fig 2	
Mcicro830	2080-LC30	CPU RS232port	RS232	Fig1	Modbus RTU( HMI is Master )

### 14.1.2 Parameters

#### 1. HMI settings

Parameter	Recommend settings	Choices of settings	Note
PLC type	AB Micrologix/SLC series (DF1 Full Duplex)	AB Micrologix/SLCseries (DF1 Full Duplex)/ Modbus RTU( HMI is Master )	None
Port	RS232		
Data bit	8		
Stop bit	1		
Parity	None Parity		
Baud rate	9600	9600/19200/38400	
Station No.	1	0~255	

AB Micrologic/SLC series (DF1 full duplex) protocol default communication parameters:

**Note:** The local station number should be set to 0.

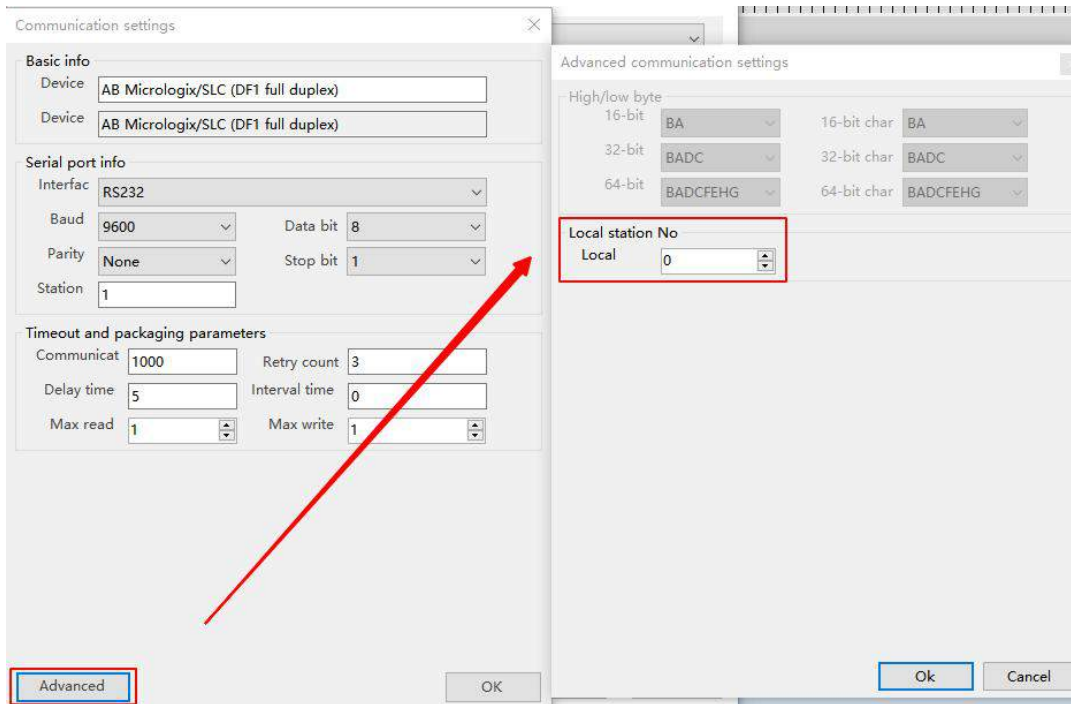

## 2. PLC settings

( 1 ) PLC protocol selection in TouchWin: AB Micrologix, SLC series (DF1 full duplex):

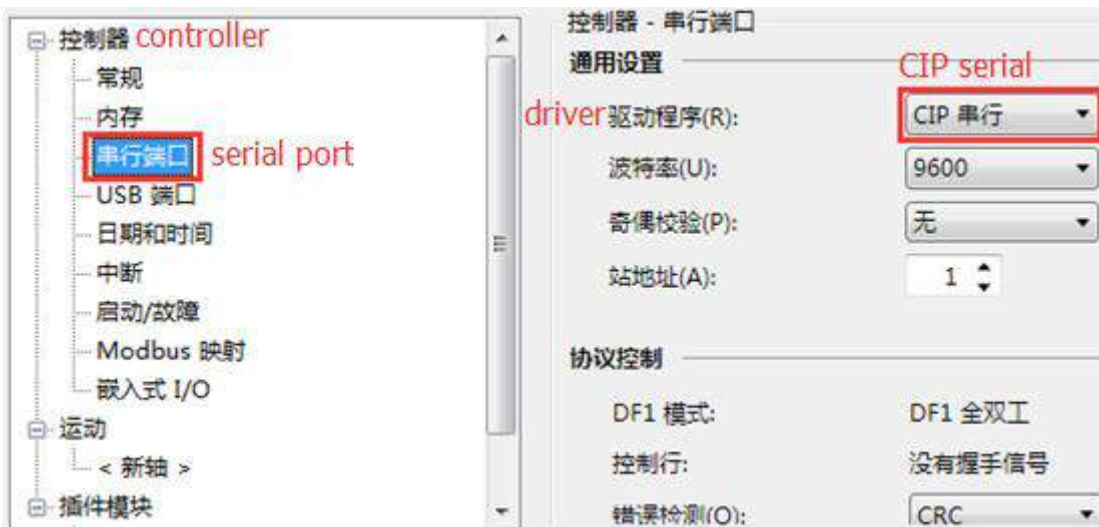

( 2 ) Select Modbus RTU (HMI is Master) for PLC protocol in TouchWin:



**Note:** When communicating with MODBUS RTU, the address needs to be configured and mapped by oneself. Address 1 in PLC corresponds to MODBUS address 0 in HMI, address 2 in PLC corresponds to MODBUS address 1 in HMI, and so on:

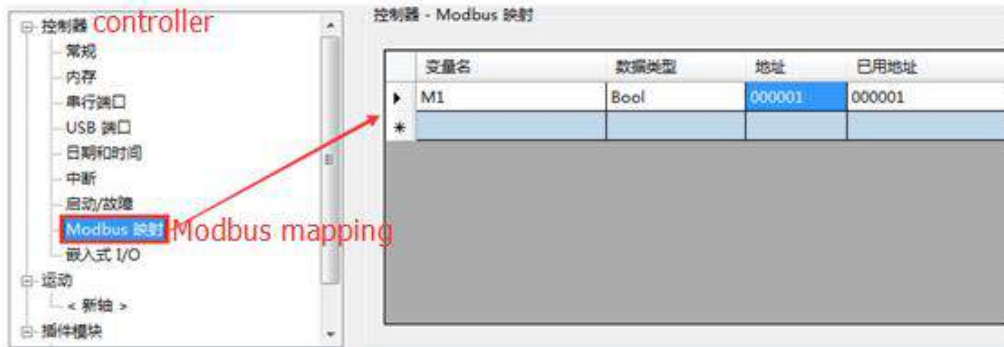

### 14.1.3 Cable making

1. AB Micrologix RS232 :

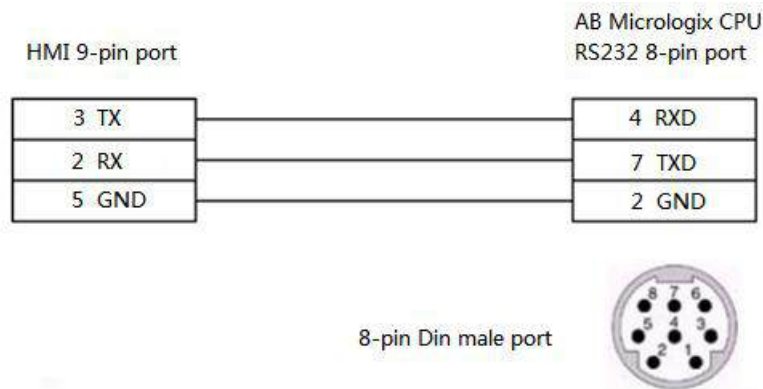

( Fig1 )

2. SLC500 RJ8 modular plug:

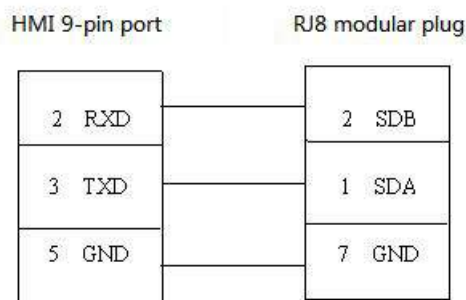

( Fig 2 )

### 14.1.4 Device address

Device address type	Range	Object type	Notes
T4DN	0~999	Bit	Timer
C5DN	0~999	Bit	Counter
O	0.00~999.15	Bit	External output coil
I	0.00~999.15	Bit	External input coil
S	0.00~999.15	Bit	
B3	0.00~999.15	Bit	
R6	0.00~999.15	Bit	

Device address type	Range	Object type	Notes
N7	0.00~999.15	Bit	
O	0~999	Word	Used as a register
I	0~999	Word	Used as a register
S	0~999	Word	Used as a register
B3	0~999	Word	Used as a register
T4PRE	0~999	Word	Timer preset value
T4ACC	0~999	Word	Timer actual value
C5PRE	0~999	Word	Counter preset value
C5ACC	0~999	Word	Counter actual value
R6	0~999	Word	Data register
N7	0~999	Word/Dword	Data register
F8	0~999	Dword	Floating point register
R6LEN	0~999	Word	
P6POS	0~999	Word	

# 15 Koyo PLC Connection Instructions

This chapter mainly introduces the connection instructions between the touch screen and Koyo PLC communication equipment.

**Note:**

- ( 1 )The Xinje TS series touch screen supports a maximum baud rate of 187.5K.
- ( 2 )During communication, please don't plug or unplug cables with power, as it may cause damage to the device's serial port.
- ( 3 )Upgrade of touch screen software version, there may be some changes in the communication protocol device address range. The device address range in the software shall prevail.

## 15.1 Koyo S series

### 15.1.1 Device type

1. Koyo Kostac series, PLC models such as SH/SM/SN (directly connected to the connection module on the CPU unit)

Series	CPU	Connected module	Port	Cable making	PLC model in Touchwin software
SH series	SH-48RS	CPU Connected module	RS232	Fig1	KoyoS series
SM series	SM24-T SM-16R SM1				
SN series					

**Note: Koyo SH-48RS, There is no Run or Stop dial switch, only one communication port ( phone port - crystal head).**

2. Koyo Kostac S series SG/SU/SR and other PLC models (using communication modules)

Series	CPU	Connected module	Port	Cable making	PLC model in Touchwin software
SG series	SG-8	G01-DM communication unit	RS232	Fig 2	KoyoS series
			RS422	Fig 3	
SU series	SU-5	U01-DM communication unit	RS232	Fig 2	
	SU-6	U01-DM communication unit			
	SU-6B	U01-DM communication unit			
SR series	SR-21	E-02DM-R1 communication unit	RS422	Fig 3	

### 15.1.2 Parameters

1. HMI settings

Parameter	Recommend settings	Choices of settings	Note
PLC type	KoyoS series		None
Port	RS232	RS232/RS422	
Data bit	8		
Stop bit	1		

Parity	Odd parity	
Baud rate	9600	9600/19200/38400
Station No.	0	

Koyo S series protocol default communication parameters:

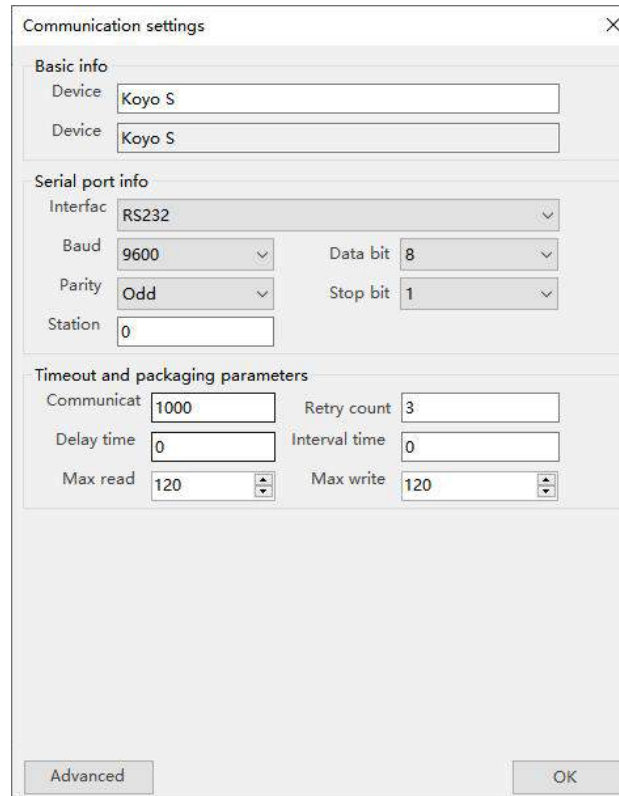

## 2. PLC settings





serial port: COM1  
 baud rate: 9600  
 odd parity

PLC: SH/SH1  
 K protocol  
 station no.1

**Note:**

- ( 1 )Koyo K protocol PLC station number cannot be modified, default 0 in touch screen software.
- ( 2 )Device register address: Starting from R2000.
- ( 3 )Security password function must be disabled.
- ( 4 )CPU units with a work mode setting switch must have the switch set to the TERM state.

15.1.3 Cable making

1. RS232 :

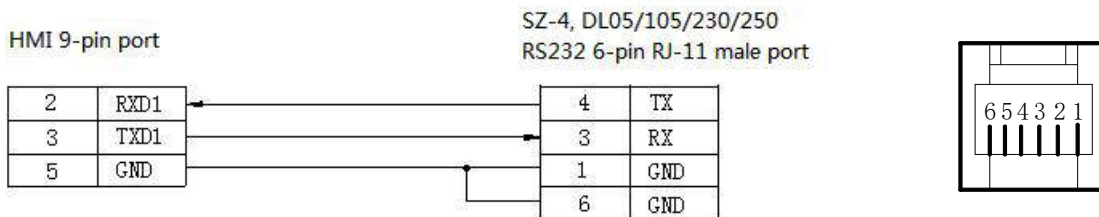

( Fig1 )

2. RS232 25-pin port on CPU or communication unit:

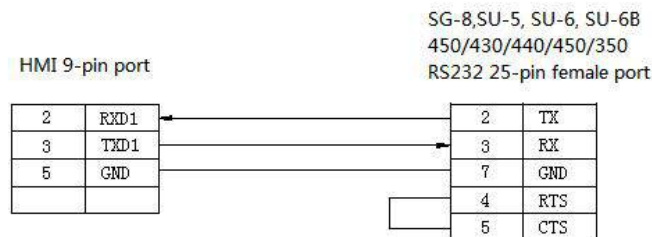

( Fig 2 )

3. RS422 :

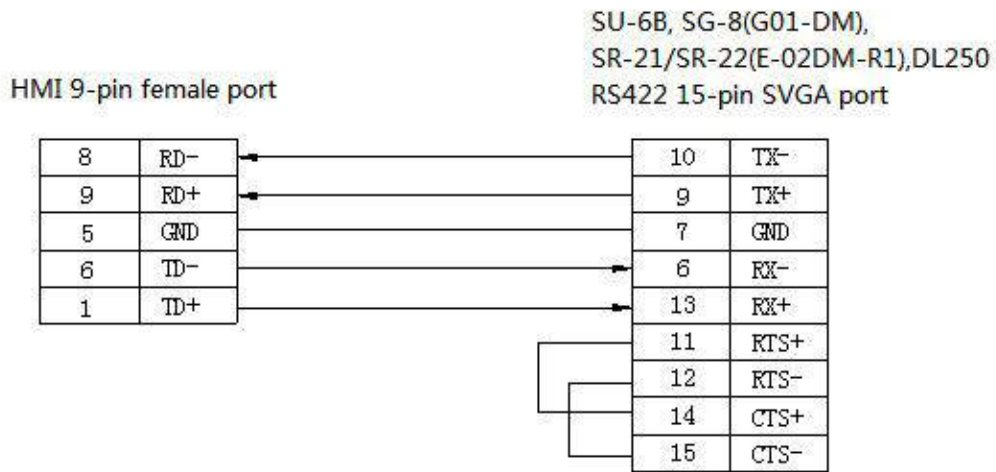

( Fig 3 )

#### 15.1.4 Device address

PLC address type	Range	Object type	Notes
M	0~777	Bit	Internal coil
I	0~777	Bit	External input coil
Q	0~777	Bit	External output coil
SP	0~777	Bit	Internal coil
T	0~777	Bit	Timer
C	0~777	Bit	Counter
S	0~777	Bit	Stepper coil
R	R.0~41200.15	Bit	Intermediate relay
R	0~41200	Word/DWord	Data register

## 15.2 Koyo Direct series

### 15.2.1 Device type

Koyo Direct Logic series DL05, DL250 and other PLC models (directly connected to CPU)

Series	CPU	Connected module	Port	Cable making	PLC model in Touchwin software
Direct Logic	DL05 DL105 DL230 DL240 DL250 DL350	Directly connect to the RJ-11 hardware interface of the CPU, i.e. RS232 communication port	RS232	Fig1	Koyo DL series
	DL430 DL440 DL450	Directly connect to the CPU communication port	RS422	Fig 2	

**Note: The PORT2 on the DL250 CPU unit combines two communication interfaces, RS232 and RS422. When using it, it's important to distinguish its communication type and select the correct cable for connecting the touch screen to the PLC.**

### 15.2.2 Parameters

#### 1. HMI settings

Parameter	Recommend settings	Choices of settings	Note
PLC type	Koyo DL series		None
Port	RS232	RS232/RS422	
Data bit	8		
Stop bit	1		
Parity	Odd parity		
Baud rate	9600	9600/19200/38400	
Station No.	0		

Koyo DL series protocol default communication parameters:

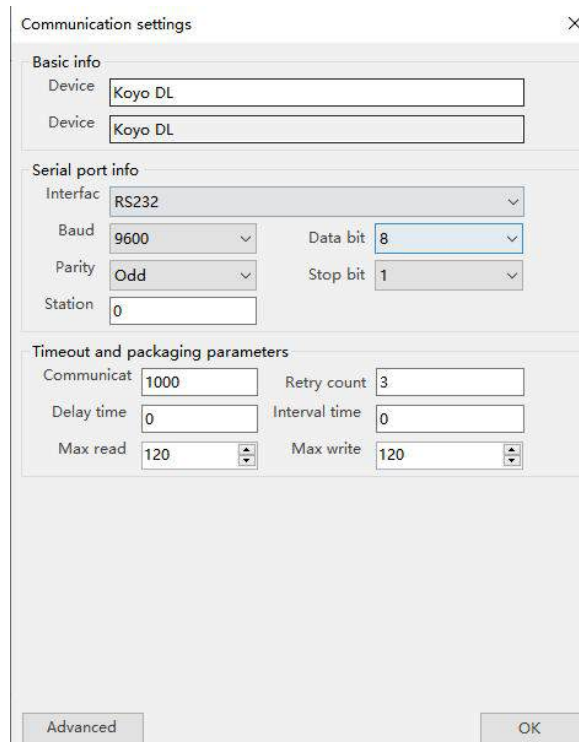

## 2. PLC settings

Please refer to Koyo S series PLC settings.

### 15.2.3 Cable making

#### 1. RS232 :

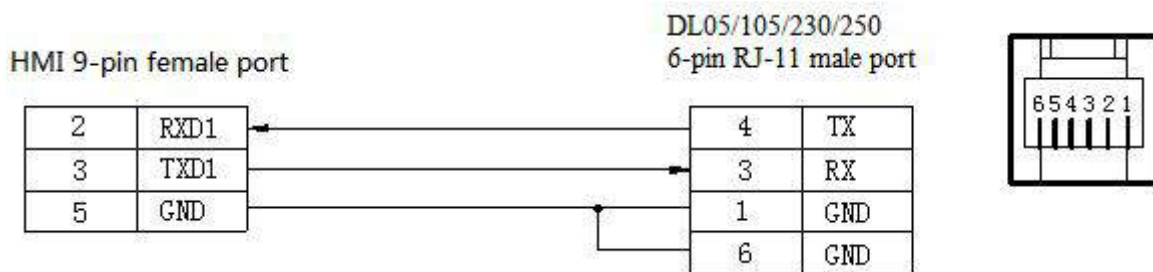

( Fig1 )

#### 2. RS422 :

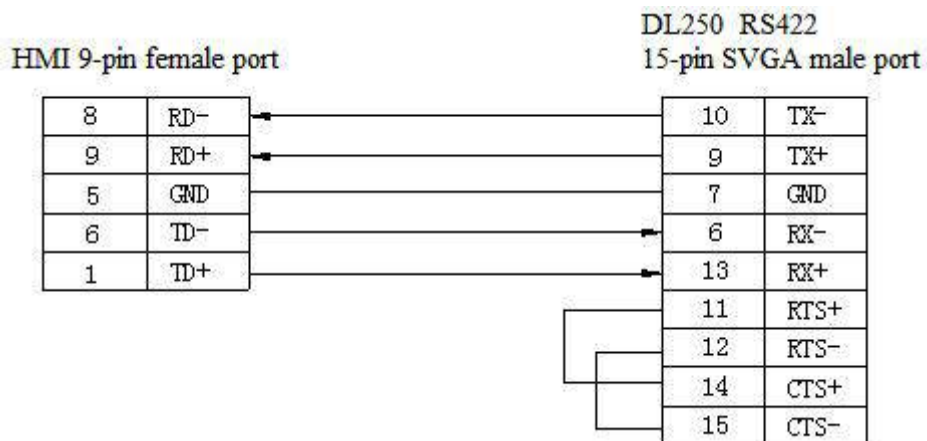

( Fig 2 )

---

## 15.2.4 Device address

Device address type	Range	Object type	Notes
V	0~41200	Word/DWord	Data register
C	0~777	Bit	Counter
X	0~777	Bit	External input coil
Y	0~777	Bit	External output coil
SP	0~777	Bit	Intermediate relay
T	0~777	Bit	Timer
CT	0~777	Bit	Counter
S	0~777	Bit	Intermediate relay
V	0.0~41200.15	Bit	Intermediate relay

# 16 ABB PLC Connection Instructions

This chapter mainly introduces the connection instructions between the touch screen and ABB PLC communication equipment.

**Note:**

- ( 1 )The Xinje TS series touch screen supports a maximum baud rate of 187.5K.
- ( 2 )During communication, please don't plug or unplug cables with power, as it may cause damage to the device's serial port.
- ( 3 )Upgrade of touch screen software version, there may be some changes in the communication protocol device address range. The device address range in the software shall prevail.

## 16.1 ABB AC500 series

### 16.1.1 Device type

ABB can communicate with the Xinje touch screen through the Modbus protocol.

Series	Port	Cable making	PLC model in Touchwin software
AC500	PM564-T-ETH	Fig1	ABB AC500 series

### 16.2.2 Parameters

#### 1. HMI settings

Parameter	Recommend settings	Choices of settings	Note
PLC type	ABB AC500 series	ABB AC500 series Modbus RTU( HMI is Master )	None
Port	RS485		
Data bit	8		
Stop bit	1		
Parity	None Parity		
Baud rate	19200	9600//19200	
Station No.	1	0~255	

ABB AC500 protocol default communication parameters:



## 2. PLC settings

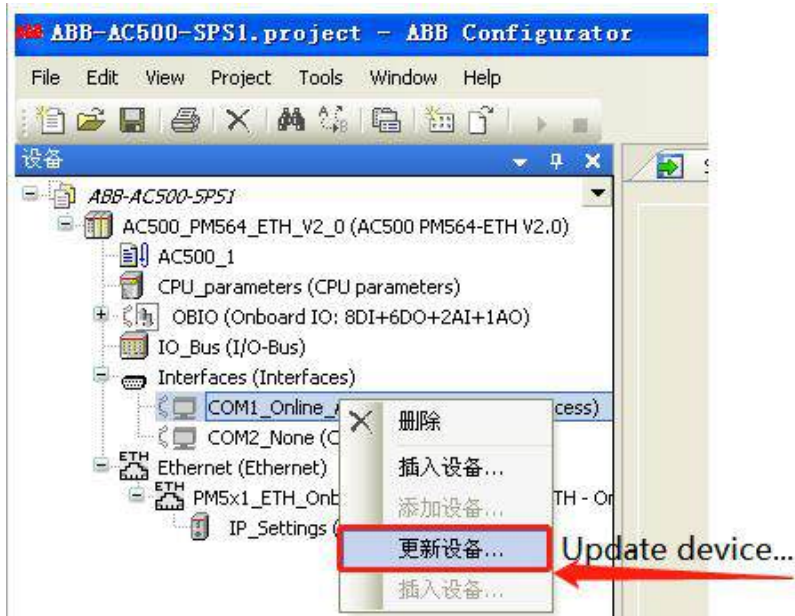

- (1) In the ABB AC500 PLC software serial port settings, the Modbus protocol needs to be selected:

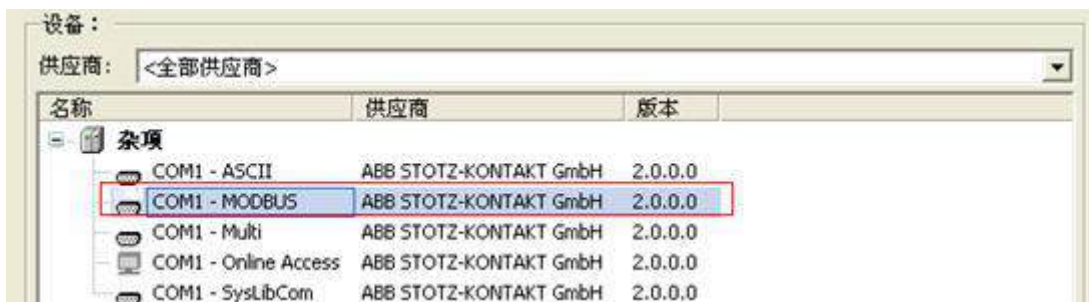

- (2) After selecting COM1 MODBUS, the serial communication settings need to set "Operation mode" to "Slave", and other parameters should be consistent with the touch screen.

COM1 - MODBUS 配置 | Modbus设置

参数	类型	值	缺省值	单位
Enable login	Enumeration of BYTE	Disabled	Disabled	
RTS control	Enumeration of BYTE	Telegram	None	
Telegram ending value	WORD(0..65535)	3	3	
Baudrate	Enumeration of DWORD	19200	19200	bits/s
Parity	Enumeration of BYTE	even	even	
Data bits	Enumeration of BYTE	8	8	bits/character
Stop bits	Enumeration of BYTE	1	1	
Run on config fault	Enumeration of BYTE	No	No	
Operation mode	Enumeration of BYTE	Slave	None	
Address	BYTE(0..255)	1	0	

### 16.3.3 Cable making

ABB COM1 (RS-485):

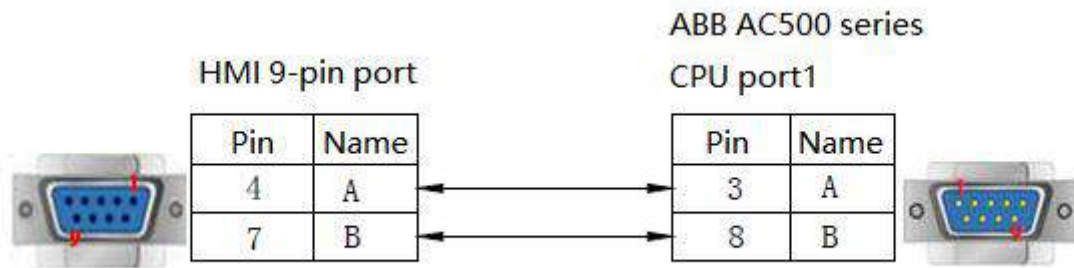

( Fig1 )

#### 16.3.4 Device address

PLC address type	Range	Object type	Notes
MX0	0.0~65535.7	Bit	Input/output/internal coil
MX1	0.0~65535.7	Bit	Input/output/internal coil
MW0	0~32767	Word	Data register
MW1	0~32767	Word	Data register
MD0	0~32767	DWord	Data register
MD1	0~32767	DWord	Data register

---

# 17 Emerson PLC Connection Instructions

This chapter mainly introduces the connection instructions between the touch screen and Emerson PLC communication equipment.

**Note:**

- ( 1 )The Xinje TS series touch screen supports a maximum baud rate of 187.5K.
- ( 2 )During communication, please don't plug or unplug cables with power, as it may cause damage to the device's serial port.
- ( 3 )Upgrade of touch screen software version, there may be some changes in the communication protocol device address range. The device address range in the software shall prevail.

## 17.1 Emerson EC20 series

### 17.1.1 Device type

Series	CPU	Connected module	Port	Cable making	PLC model in Touchwin software
EC20	EC20	COM0 port	RS232	Fig1	Emerson EC20 series
		COM1 port	RS485	Fig 2	
			RS232	Fig 3	

### 17.1.2 Parameters

#### 1. HMI settings

Parameter	Recommend settings	Choices of settings	Note
PLC type	Emerson EC20 series		None
Port	RS232	RS232/RS485	
Data bit	8		
Stop bit	1		
Parity	Even parity		
Baud rate	19200	9600/19200/115200	
Station No.	1	0~255	

Emerson EC20 series protocol default communication parameters:

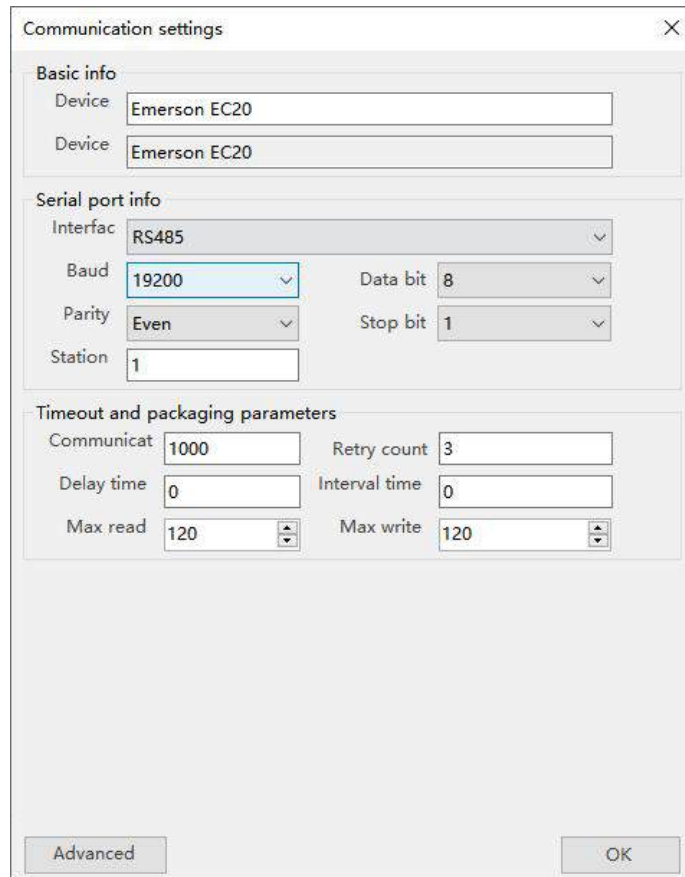

## 2. PLC settings

### (1) COM0port setting :



(2) COM1 port setting :



### 17.1.3 Cable making

1. Emerson EC20 PLC COM0 (RS232):

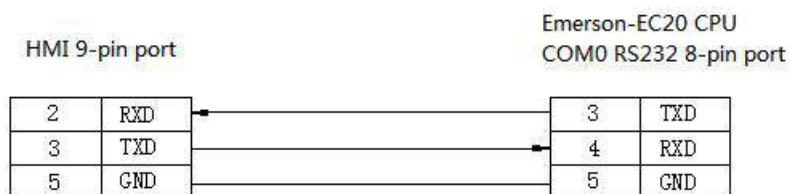

( Fig1 )

2. Emerson EC20 PLC COM1 (RS232) :

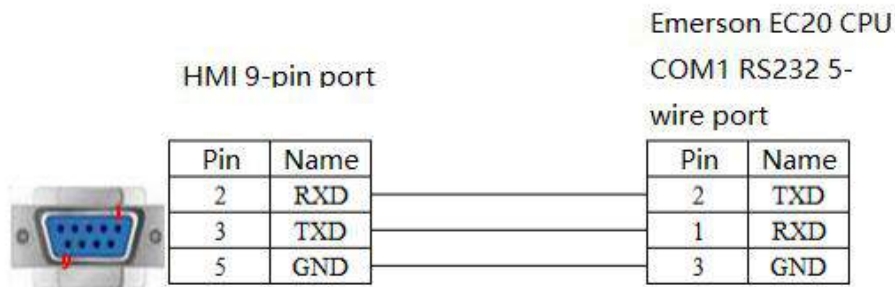

( Fig 2 )

3. Emerson EC20 PLC COM1 (RS485) :

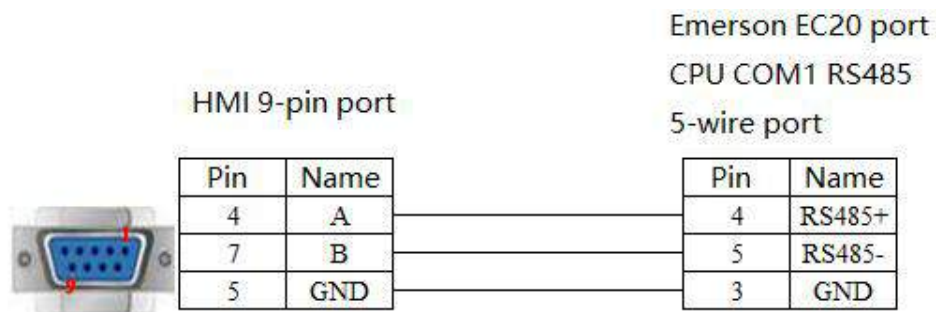

( Fig 3 )

**Note: The COM1 port of Emerson EC20 series PLC supports RS232 and RS485 wiring methods.**

17.1.4 Device address

PLC address type	Range	Object type	Notes
X	0~377	Bit	External input coil
Y	0~377	Bit	External output coil
M	0~2047	Bit	Internal coil
S	0~1023	Bit	Internal special step relay
T	0~255	Bit	Timer
C	0~255	Bit	Counter
SM	0~255	Bit	Special internal auxiliary relay
D	0~7999	Word/DWord	Data register
SD	0~255	Word/DWord	Used as a register
Z	0~15	Word	Used as a register
T	0~255	Word/DWord	Used as a register
C16	0~199	Word	16-bit counter
C32	200~255	DWord	32-bit counter

# 18 Schneider PLC Connection Instructions

This chapter mainly introduces the connection instructions between the touch screen and Schneider PLC communication equipment.

**Note:**

- ( 1 )The Xinje TS series touch screen supports a maximum baud rate of 187.5K.
- ( 2 )During communication, please don't plug or unplug cables with power, as it may cause damage to the device's serial port.
- ( 3 )Upgrade of touch screen software version, there may be some changes in the communication protocol device address range. The device address range in the software shall prevail.

## 18.1 Schneider Micro/Neza/Twido series

### 18.1.1 Device type

Series	CPU	Connected module	Port	Cable making	PLC model in Touchwin software
Micro series	TSX 37-05 TSX 37-08 TSX 37-10 TSX 37-21/22	CPU direct connection	RS485	Fig1	Schneider Micro/Neza/Twido series
Twido series	Twido series CPU	CPU direct connection	RS485	Fig1	
M series	M218 M238 M258	CPU direct connection	RS485	Fig 2	
NEZA series	TSX07 series CPU	CPU direct connection	RS485	Fig1	

### 18.1.2 Parameters

#### 1. HMI settings

Parameter	Recommend settings	Choices of settings	Note
PLC type	Schneider Micro/Neza/Twido series		None
Port	RS485		
Data bit	8		
Stop bit	1		
Parity	None		
Baud rate	19200	9600/19200/38400/57600/115200	
Station No.	1	0~255	

Schneider Micro/Neza/Twido series protocol default communication parameters:

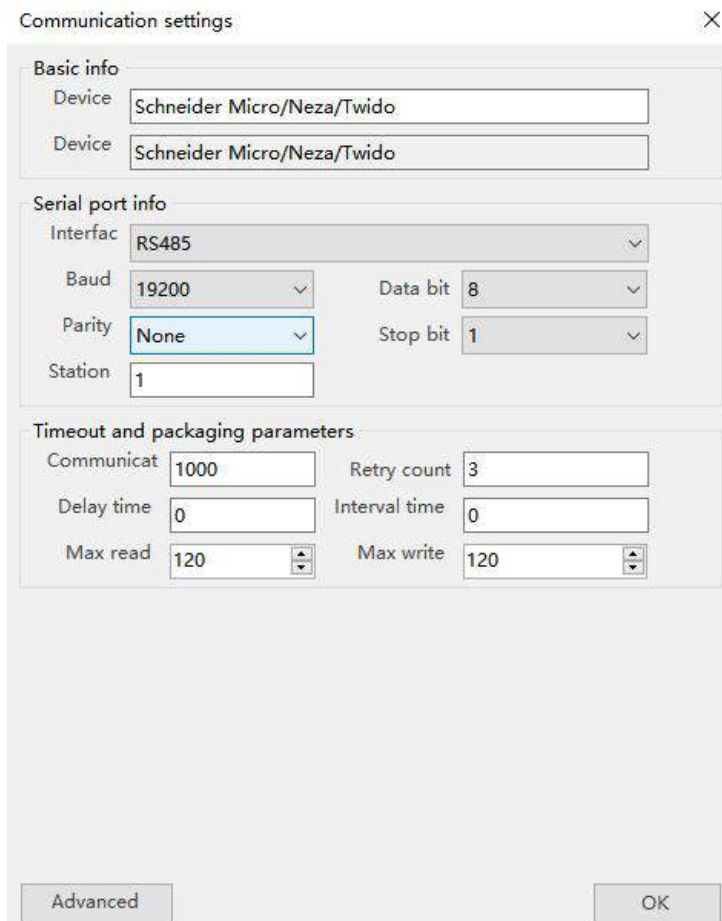

## 2. PLC settings

Click on "Hardware/Configure PLC communications" to set its communication parameters:

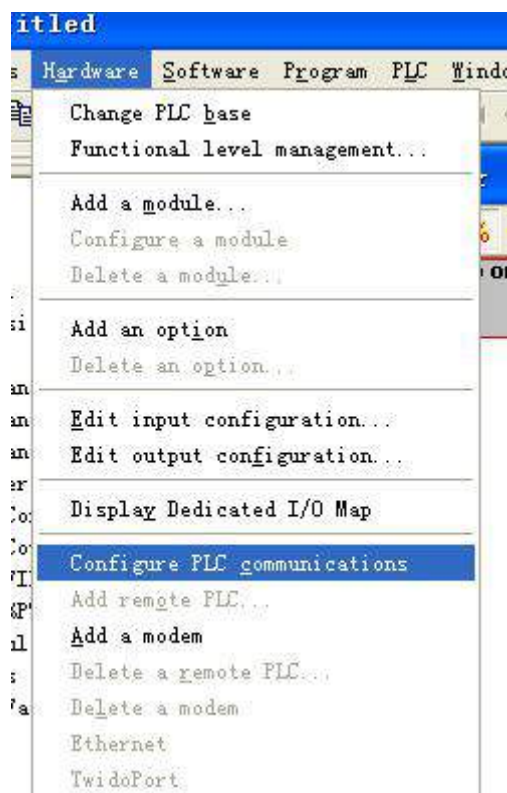

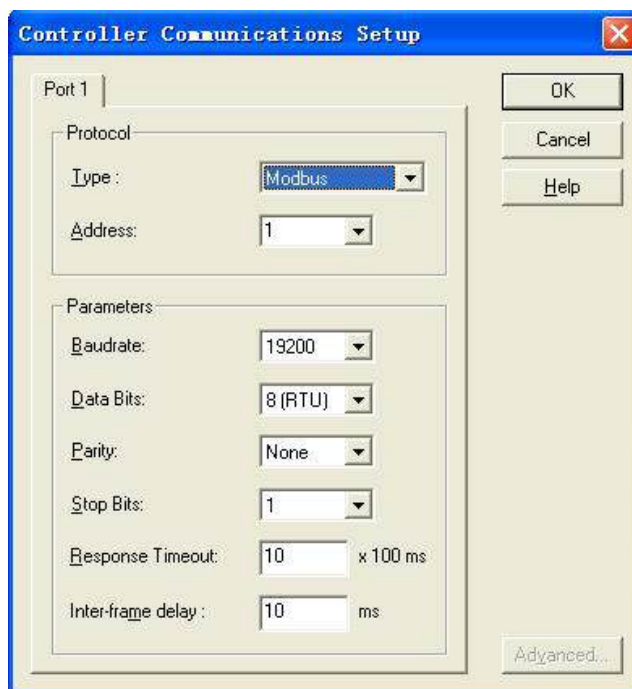

**Note:**

( 1 )The Twido PLC object address adopts a dynamic management method, which can enlarge the range in PLC editing software. However, for the enlarged object, the maximum value object address must be output or operated on in the PLC, so that the enlarged address can be used normally. Eg: Open M-bit object address range to 127, output% M127 through PLC programming software.



( 2 )Open the address range of the word object. In "Controller" - "Memory Usage" - "Edit", enter a value for "Auto" in the "Internal Word" object "Configuration". Eg: Enter 3000, so that all addresses before% MW3000 can be exchanged.



### 18.1.3 Cable making

1. Direct connect to CPU:

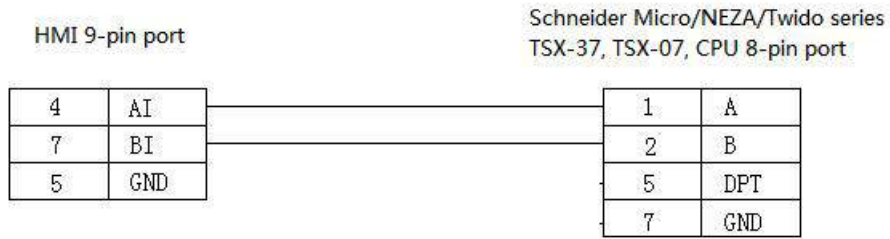

( Fig1 )

2. M238 RJ-45 RS485:

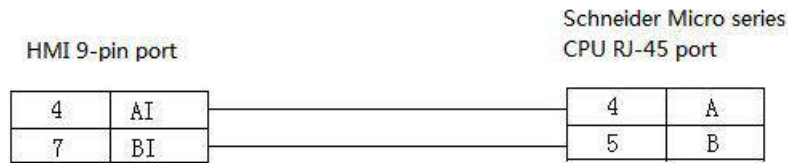

( Fig 2 )

### 18.1.4 Device address

PLC address type	Range	Object type	Notes
M	0~2047	Bit	Internal coil
MW	0.00~65535.15	Bit	Internal coil
MW	0~2047	Word/DWord	Register

---

# 19 HaiWell PLC Connection Instructions

This chapter mainly introduces the connection instructions between the touch screen and HaiWell PLC communication equipment.

**Note:**

- ( 1 )The Xinje TS series touch screen supports a maximum baud rate of 187.5K.
- ( 2 )During communication, please don't plug or unplug cables with power, as it may cause damage to the device's serial port.
- ( 3 )Upgrade of touch screen software version, there may be some changes in the communication protocol device address range. The device address range in the software shall prevail.

## 19.1 HaiWell ( Modbus RTU ) series

### 19.1.1 Device type

Series	CPU	Connected module	Port	Cable making	PLC model in Touchwin software
E/S series	HW-S16ZR220R	CPU direct connection	RS232	Fig1	Haiwell( Modbus RTU )
			RS485	Fig 2	

### 19.1.2 Parameters

#### 1. HMI settings

Parameter	Recommend settings	Choices of settings	Note
PLC type	Haiwell( Modbus RTU )		None
Data bit	8		
Stop bit	2		
Parity	None Parity		
Baud rate	9600	4800/9600/19200/38400/57600	
Station No.	1		

HaiWell E/S series uses default communication parameters for Haiwell (Modbus RTU):

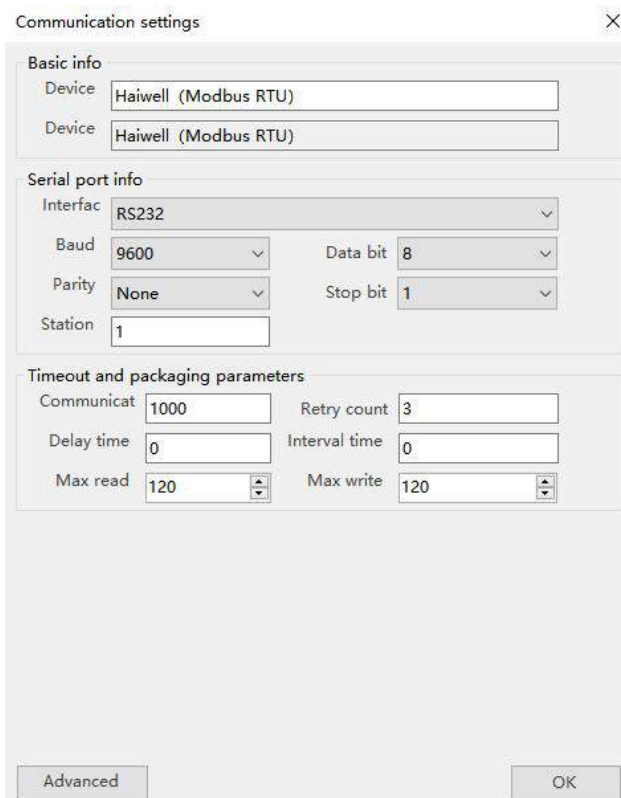

## 2. PLC settings

Select the Modbus RTU (Slave) protocol for communication protocol.

### 19.1.3 Cable making

#### 1. E/S series PLC RS232:

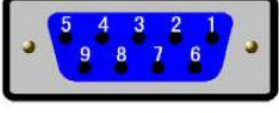
Haiwell PLC port	RS232 connection	HMI port
 4-pin S-type male port (same to programming cable)	TX 2 ————— 2 RXD RX 1 ————— 3 TXD GND 3 ————— 5 GND	 9-pin D-type female port

( Fig1 )

#### 2. E/S series PLC RS485:

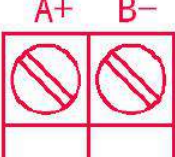
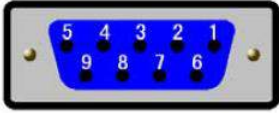
Haiwell PLC port	RS485 connection	HMI port
	A+ ————— 4 AI B- ————— 7 BI	 9-pin D-type female port

( Fig 2 )

### 19.1.4 Device address

PLC address type	Range	Modbus Address Table	Reading and writing types	Notes
------------------	-------	----------------------	---------------------------	-------

X	X0~X1023	0~1023	Readable	External input coil
Y	Y0~Y1023	1536~2559	Read/Write	External output coil
M	M0~M12287	3072~15359	Read/Write	Internal coil
T	T0~T1023	15360~16383	Read/Write	Timer
C	C0~C255	16384~16639	Read/Write	Counter
SM	SM0~SM215	16896~17111	All readable Partially writable	System status bit
S	S0~S2047	28672~30719	Read/Write	Step status bit
CR		00~4F	All readable Partially writable	Analog and special module parameter registers
AI	AI0~AI255	0000~00FF	Readable	Analog input register
AQ	AQ0~AQ255	0100~01FF	Read/Write	Analog output register
V	V0~V14847	0200~3BFF	Read/Write	Internal register
TCV	TCV0~TCV1023	3C00~3FFF	Read/Write	Timer
CCV	CCV0~CCV255	4000~40FF	Read/Write	Counter
SV	SV0~SV154	4400~448B	All readable Partially writable	System register

## 19.2 HaiWell bus TCP series

### 19.2.1 Device type

Series	Port	Cable making	PLC model in Touchwin software
HaiWell PLC	RJ45	Fig 1 or Fig 2	Haiwellbus TCP

### 19.2.2 Parameters

#### 1. PLC settings

Open the PLC software and set the IP address of the PLC to 192.168.1.111 in the Ethernet settings.

#### 2. HMI settings

- (1) After selecting the human-machine interface model as - E, click to enter the next step, select "Net1" in the device list, and set the IP address used for the human-machine interface in "Set Local IP". As long as it doesn't conflict with other IPs in the network, it's sufficient, in this example, the PLC IP is 192.168.1.111, and the device itself can be set to 192.168.1.11.

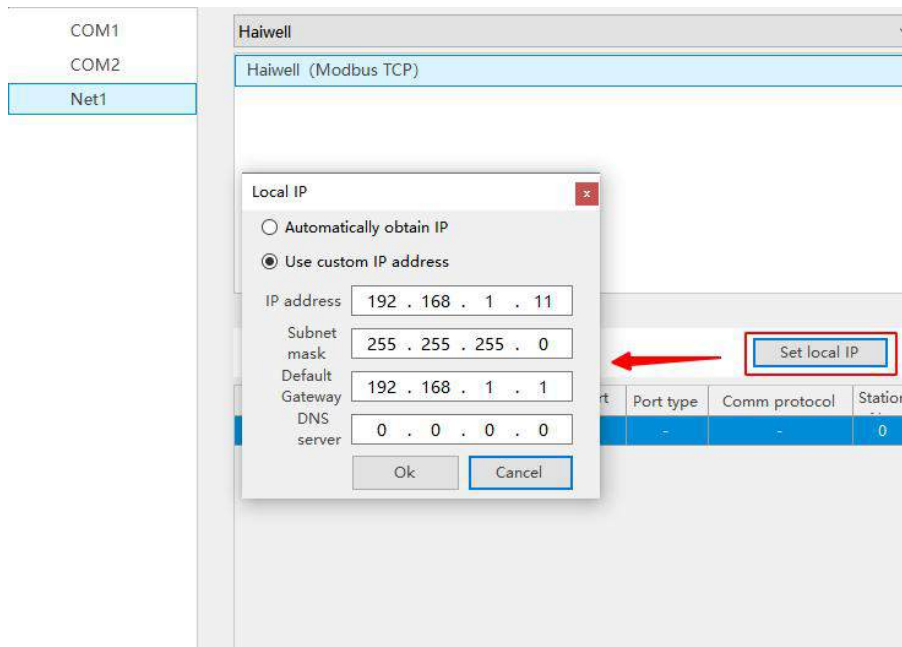

- (2) Select "Net1", click the drop-down button, and select "HaiWell" from the brand list:

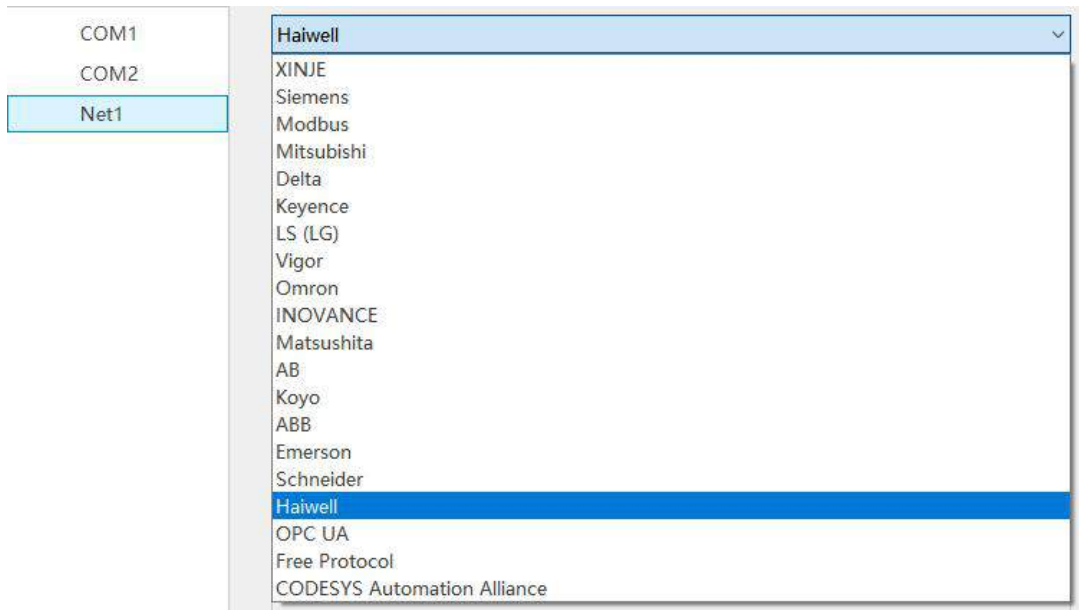

- (3) Click on "Haiwell (Modbus TCP)" in the model list, then select "New Device" and set the communication parameters in the pop-up communication settings window. This IP address is the IP address of HaiWell PLC (which can be set through PLC software), and the port number is the "Local Port Number" (decimal) set in the PLC software. After setting up, click "Confirm".

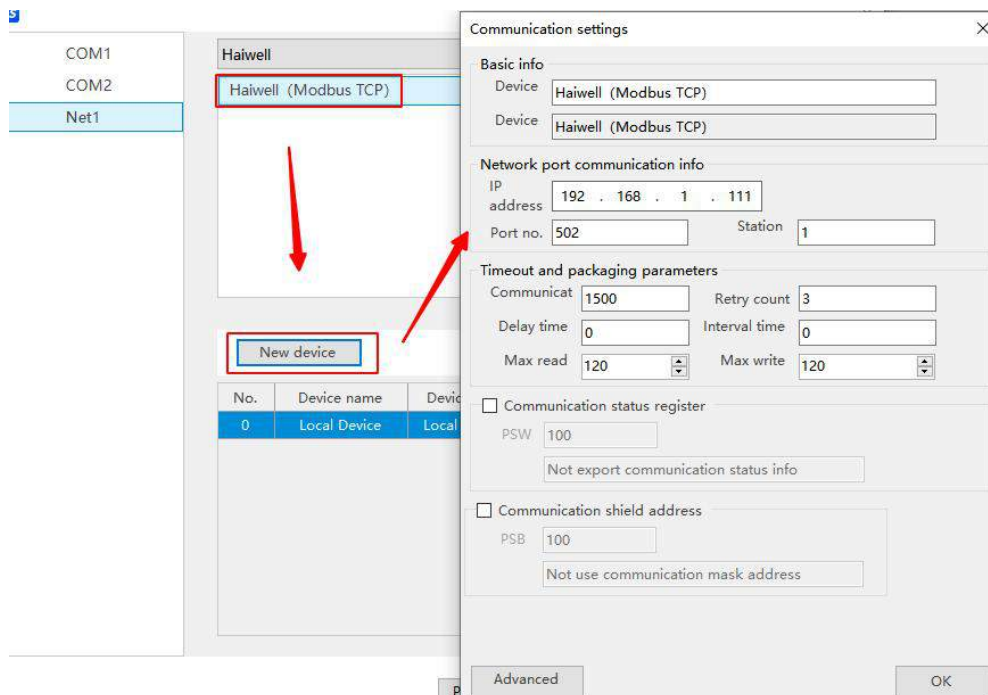

- (4) Check the "Communication Status Register", set PSW to 100, and select PSW100~PSW103 as the communication success number, communication failure number, communication timeout number, and communication error number. Customers can set this communication status address themselves.

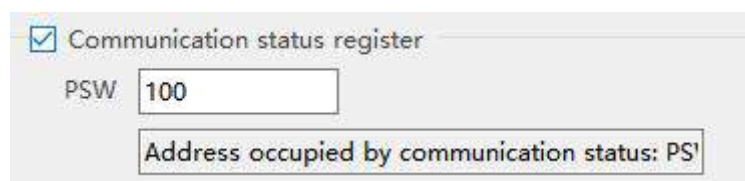

- (5) After setting up, click "OK" to end the setup and enter the screen editing interface. Place a data External

input coil component on the screen and select it from the device drop-down bar, select the corresponding device "Haiwell (Modbus TCP)":

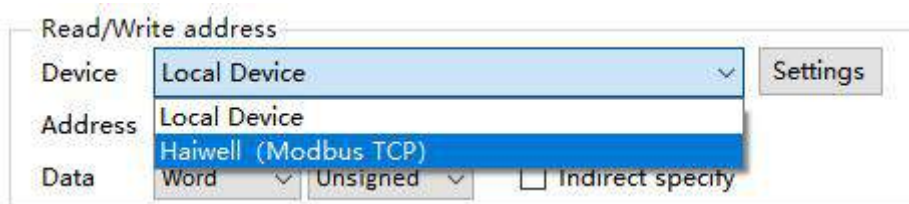

### 19.2.3 Cable making

RJ45 Straight Through Cable (connected to HUB) or RJ45 Crossover Cable :

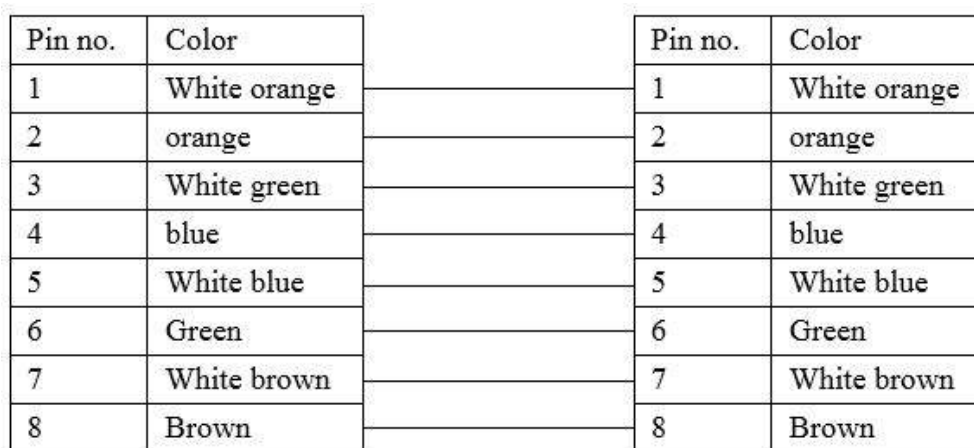

( Fig 1 )



( Fig 2 )

### 19.2.4 Device address

PLC address type	Range	Object type	Notes
X	0~1023	Bit	Switching input
Y	0~1023	Bit	Switching output
M	0~12287	Bit	Internal relay
T	0~1023	Bit	Timer
C	0~255	Bit	Counter
SM	0~215	Bit	System status bit

---

S	0~2047	Bit	Stepper coil
CR	0~255	Word/DWord	Expansion module parameters
AI	0~255	Word/DWord	Analog input
AQ	0~255	Word/DWord	Analog output
V	0~14847	Word/DWord	Internal register
TV	0~1023	Word/DWord	Timer
CV	0~255	Word/DWord	Counter
SV	0~900	Word/DWord	Stepper coil

---

## 20 OPC UA Device Connection Instructions

This chapter mainly introduces the connection instructions between the touch screen and OPC UA communication devices.

**Note:**

- ( 1 )The Xinje TS series touch screen supports a maximum baud rate of 187.5K.
- ( 2 )During communication, please don't plug or unplug cables with power, as it may cause damage to the device's serial port.
- ( 3 )Upgrade of touch screen software version, there may be some changes in the communication protocol device address range. The device address range in the software shall prevail.

### 20.1 OPC UA Client——Label communication

#### 20.1.1 Device type

Applicable to supporting the OPC UA protocol, this chapter mainly takes the Xinje XS series PLC as an example to carry out OPC UA Client label protocol communication.

Series	CPU	Connected module	Port	Cable making	PLC model in Touchwin software
XS series	XS3/XSDH XSLH/XSA	CPU direct connection	RJ45	Fig 1 or Fig 2	Xinje XS series ( Codesys )

#### 20.1.2 Parameters

Taking XSDH series PLC as an example, use the Xinje XS Studio software to explain the communication settings of the Xinje XS series (Codesys) protocol equipment.

1. PLC settings:

- (1) Open the XS Studio software to create a new project, select the standard project, and select the XSDH-60A32 model. After completing the selection, click OK.

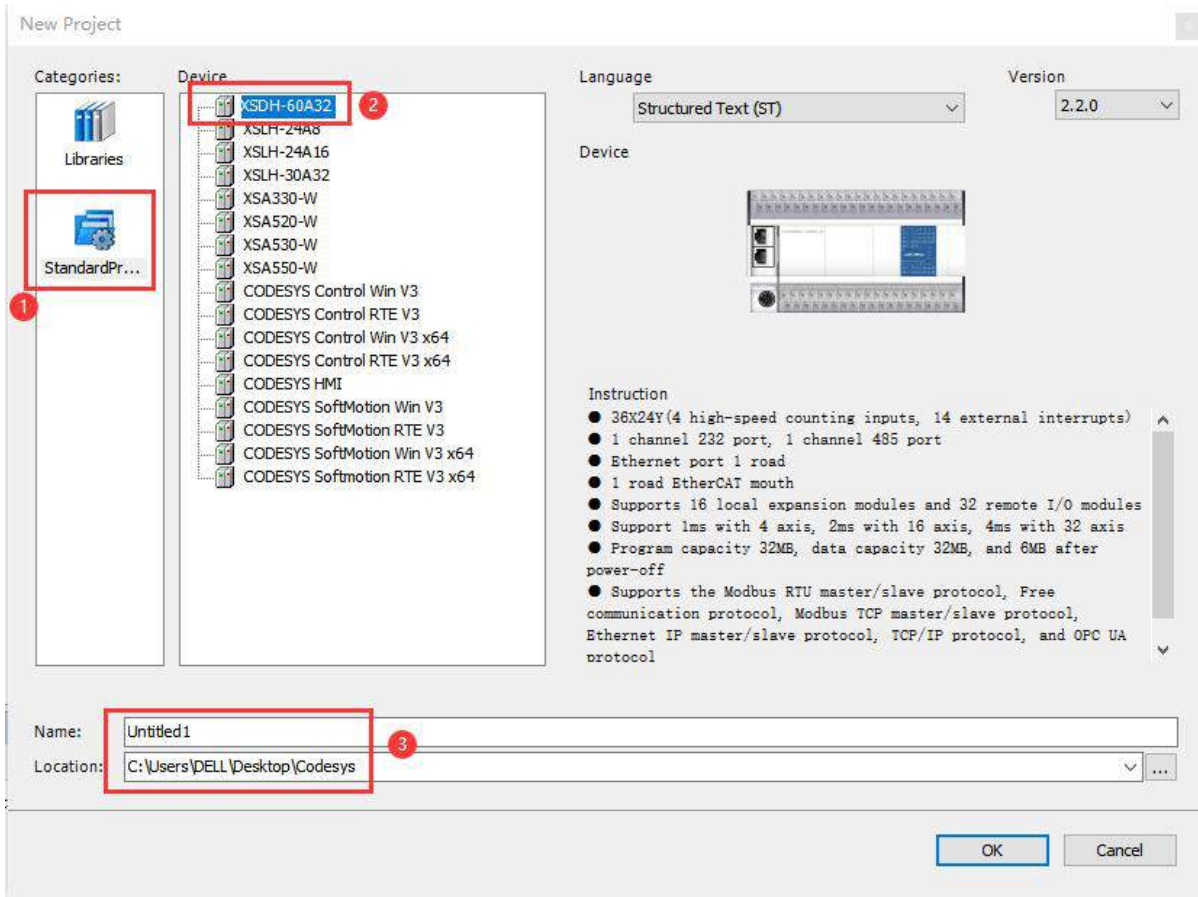

- (2) Add variables to PLC, taking the example of adding variables to a new POU: right-click on Application - Add Object - POU.

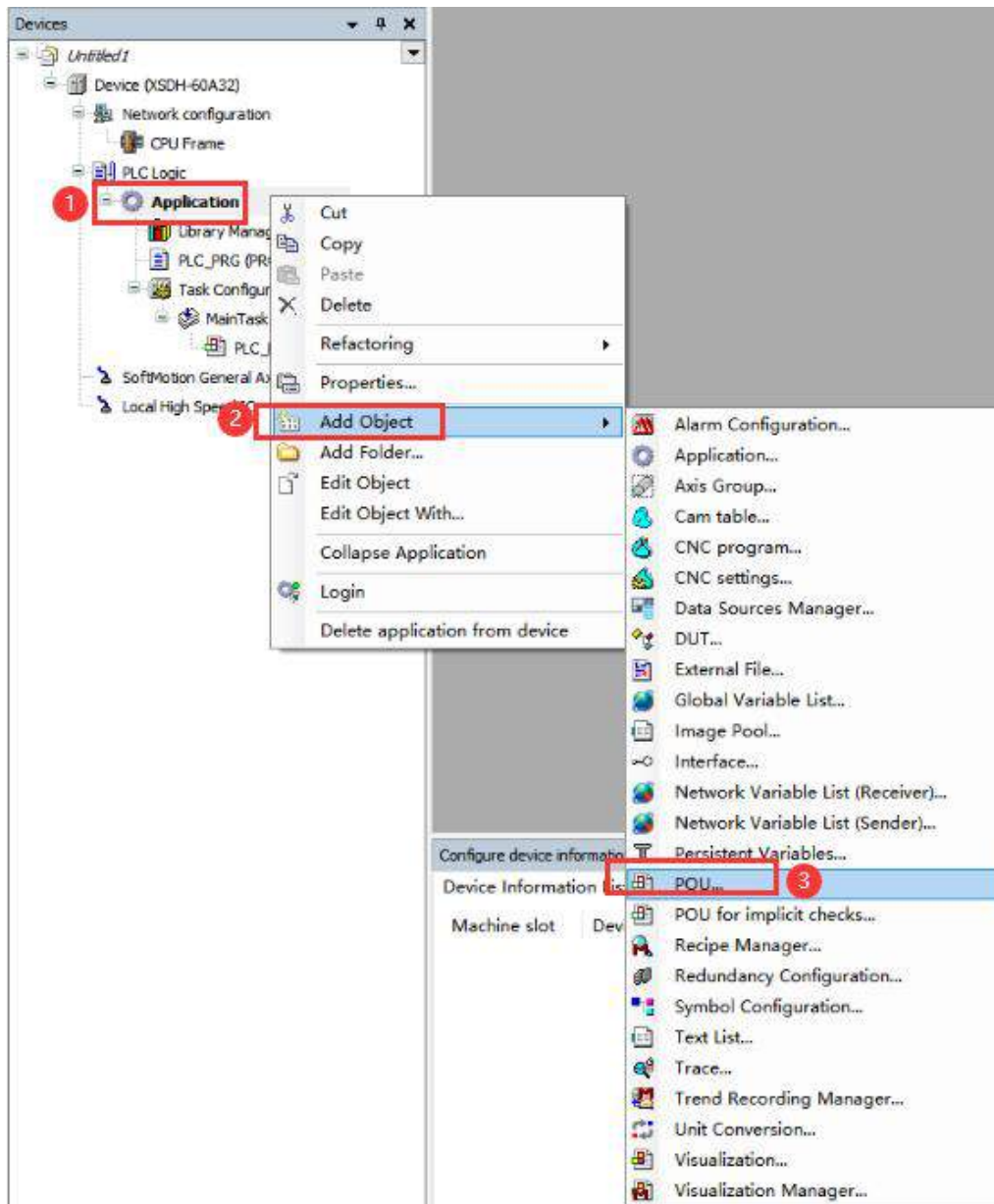

- (3) Taking the example of adding variables to POU to create BOOL type variables aa and INT type variables bb, the current supported data types can be found in [2.4.4](#). After creation, click compile.

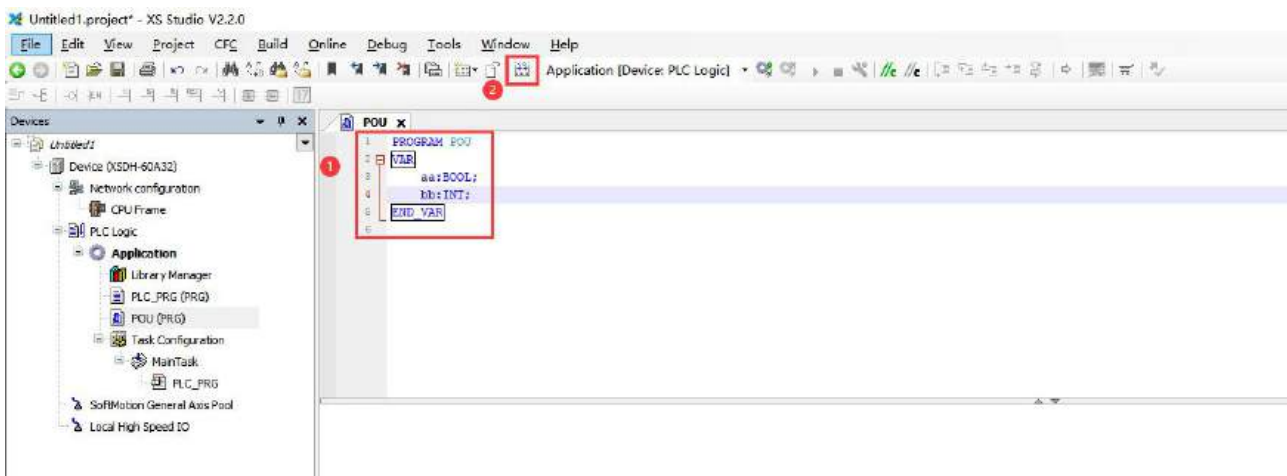

- (4) Right click on Application - Add Object - Symbol Configuration.

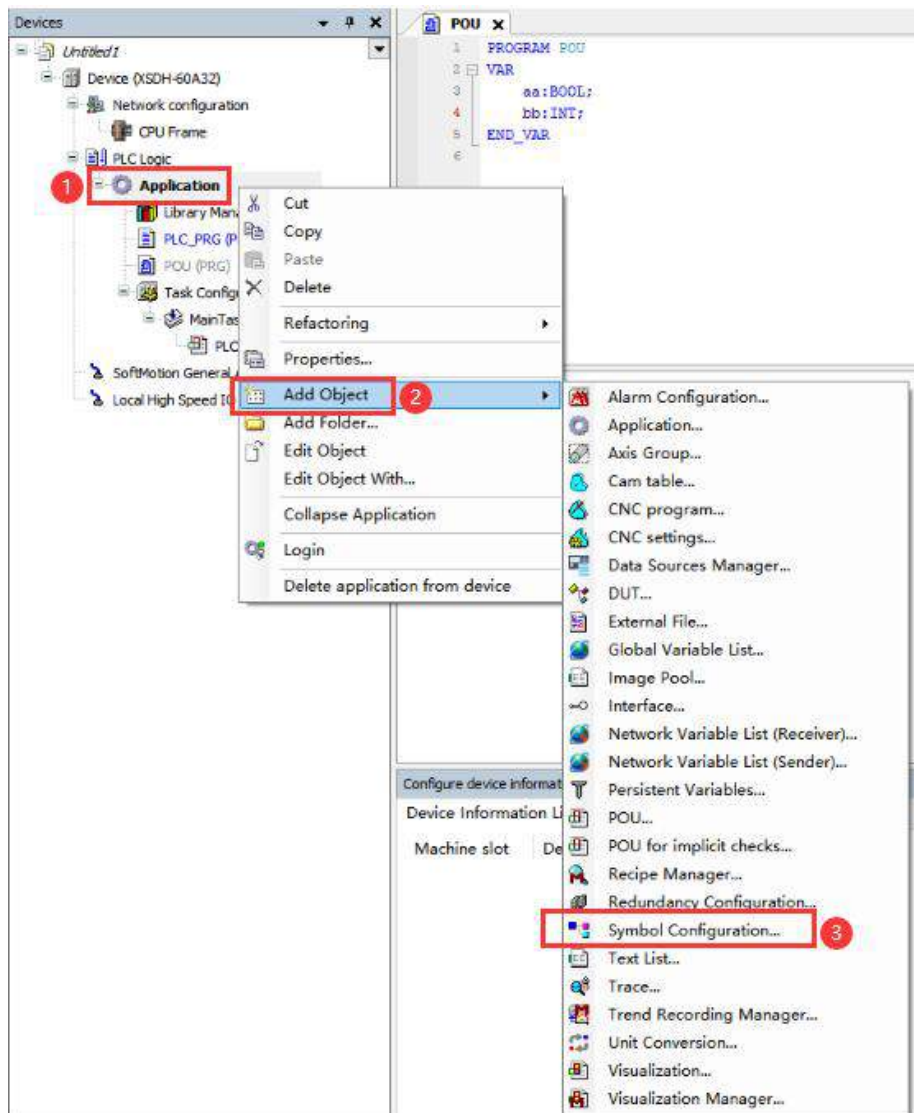

(5) Click to open, check all options, click compile.

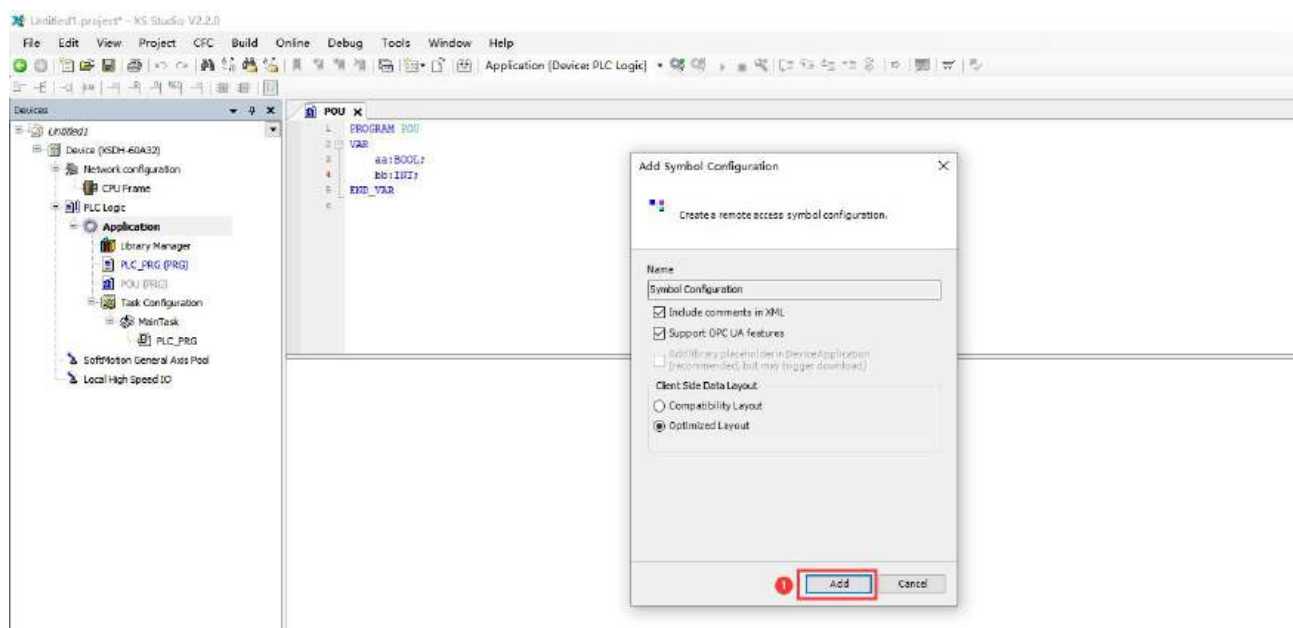

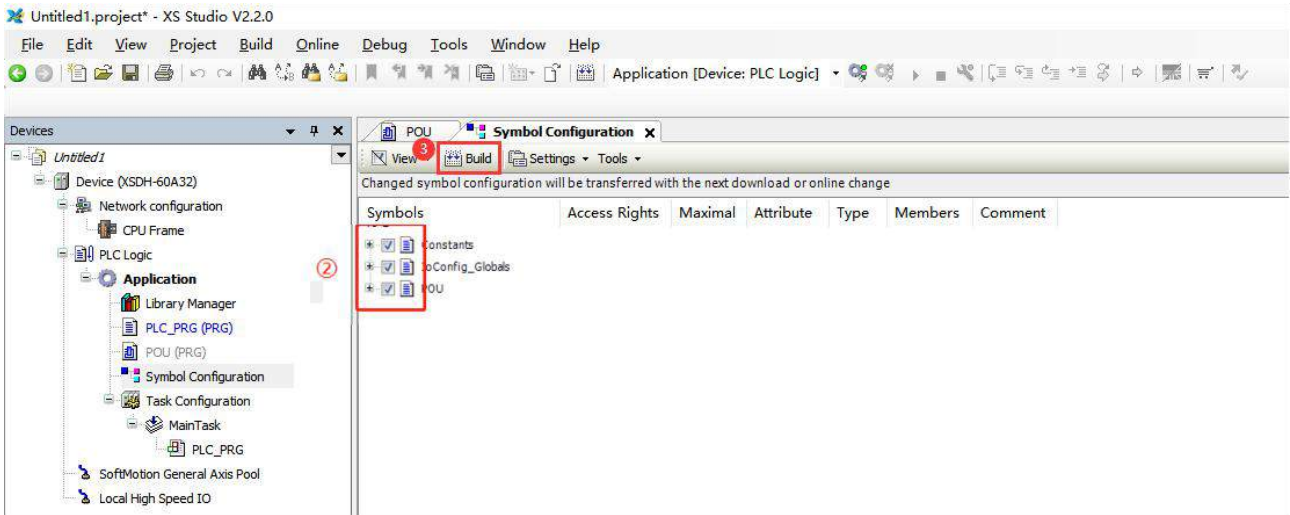

(6) Log in to the PLC and download the program. At this time, the corresponding XML file will be automatically generated in the corresponding directory of the program creation.

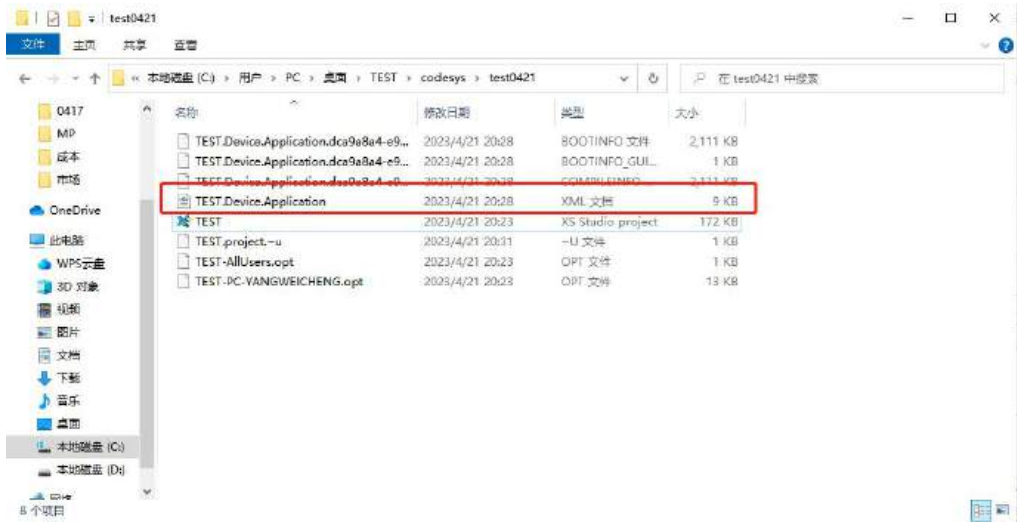
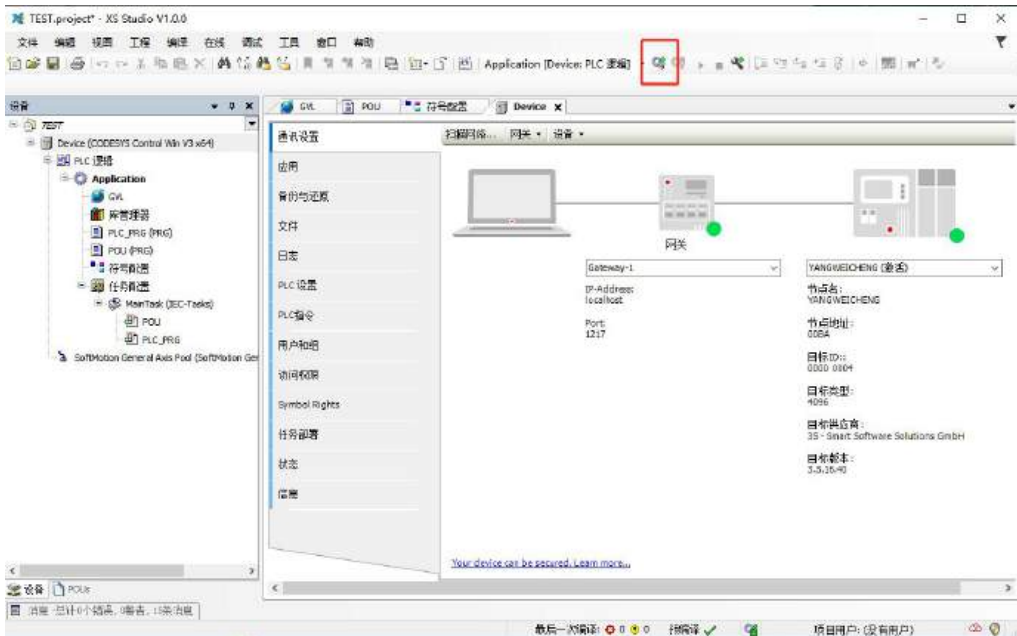

## 2. HMI settings

- (1) After selecting the human-machine interface model as - E, click to enter the next step, select "Net1" in the device list, and in "Set Local IP", IP address: the IP address of the human-machine interface, as long as it doesn't conflict with other IPs in the network. In this example, the IP of the PLC is 192.168.6.6, and the device itself can be set to 192.168.6.2.

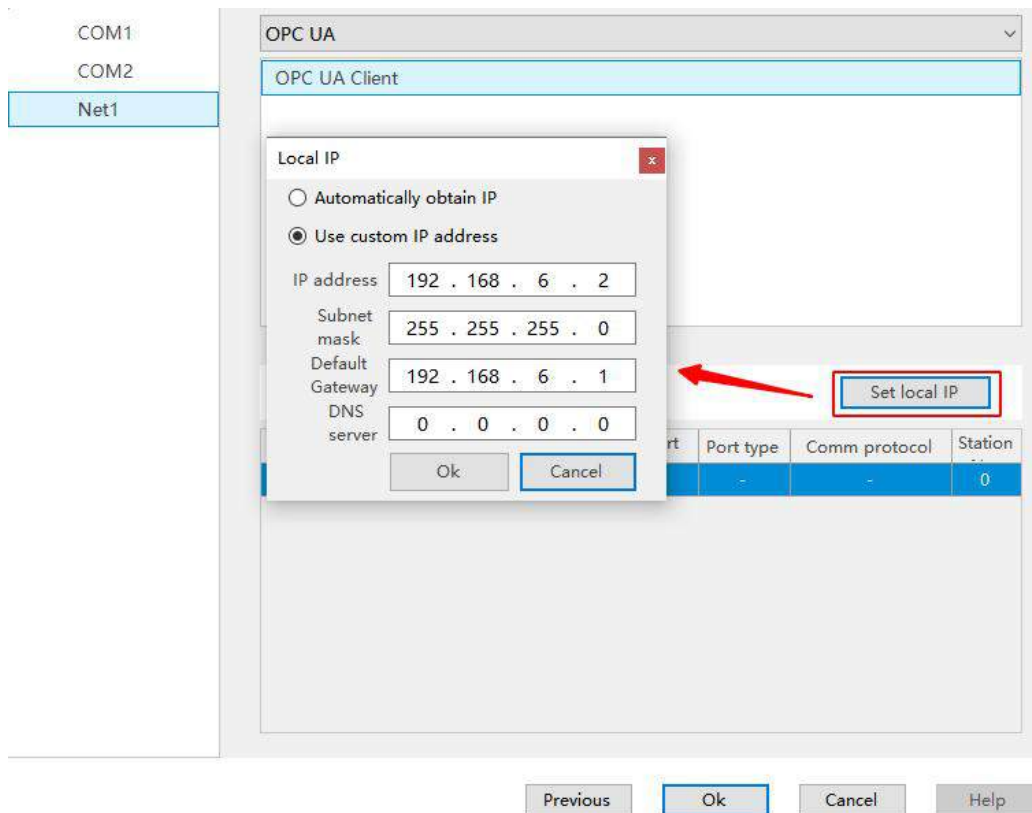

- (2) Click the drop-down button, select "OPC UA" from the brand list, click the mouse to select "OPC UA Client", then select "New Device", and set communication parameters such as device name and IP in the pop-up communication settings window. This IP address is the IP address of Xinje PLC. After setting, click "Confirm".

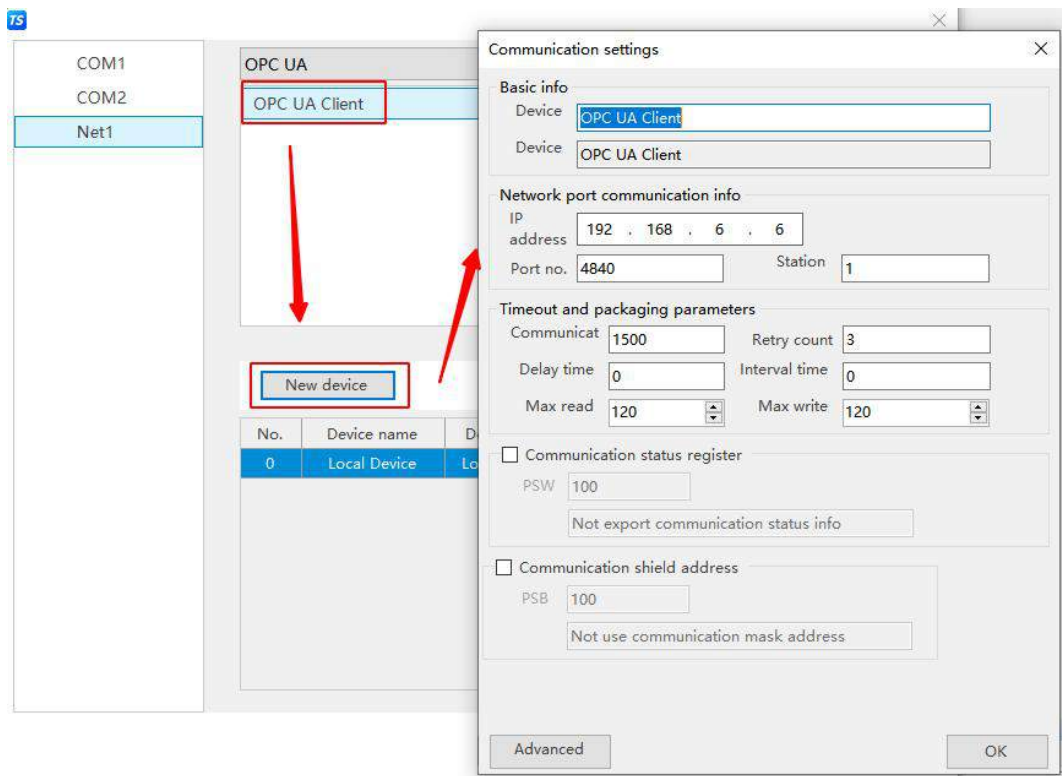
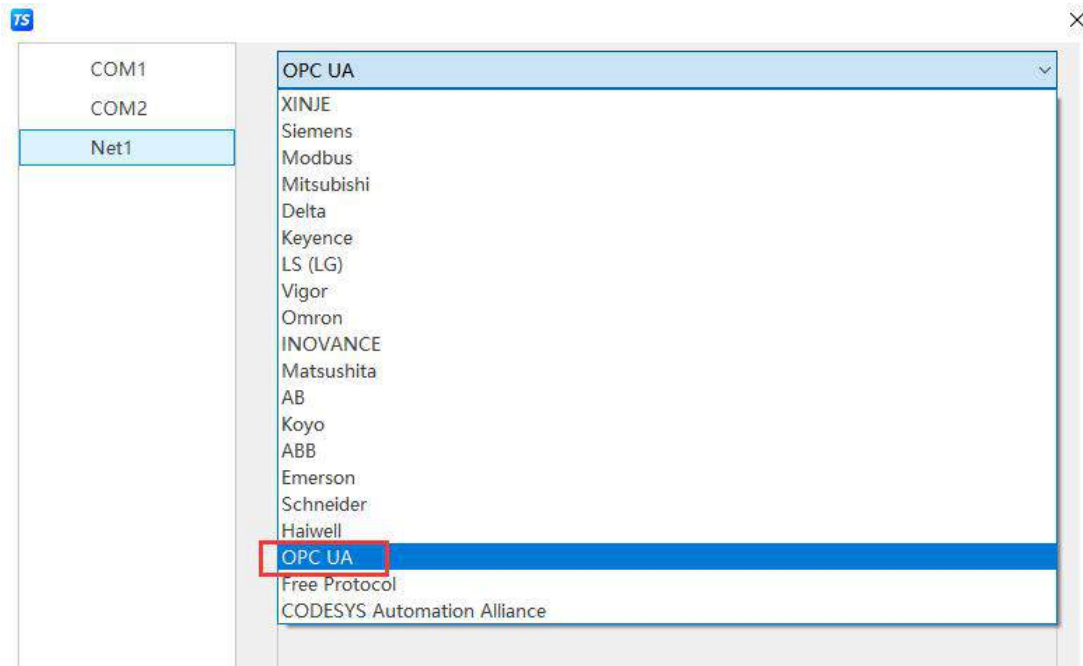

- (3) Check the "Communication Status Register" and PSW is set to 100 by default. PSW100~PSW103 represent the number of successful communication attempts, communication failures, communication timeouts, and communication errors, respectively. Customers can set this communication status register themselves.



- (4) Click on the import label, select the folder where the label was created, and select the corresponding label. A window for successfully importing xx labels will pop up, and click close:

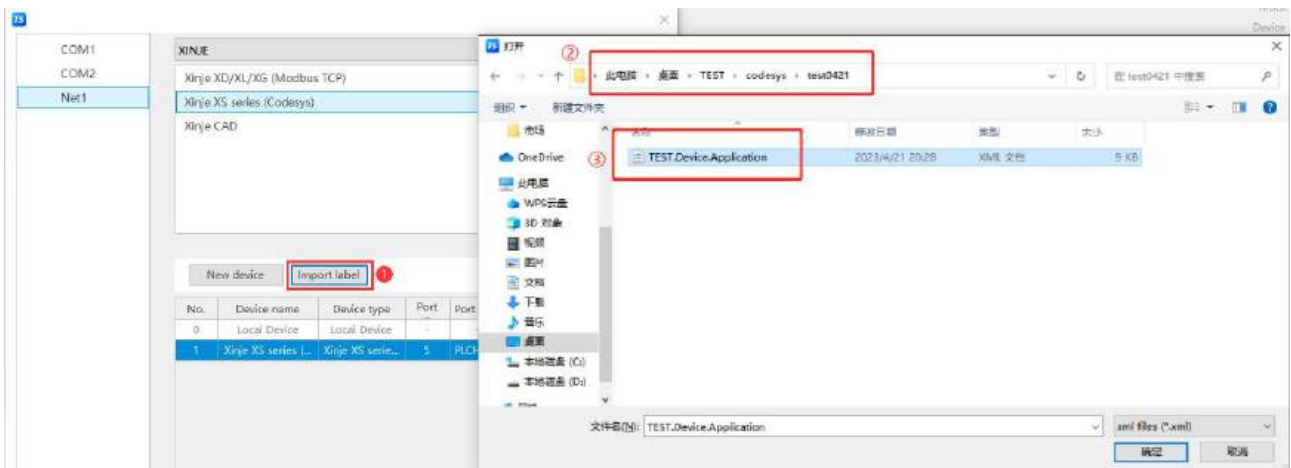

- (5) After clicking OK to complete the settings, click "Confirm" to end the settings and enter the screen editing interface. Place a numerical input component on the screen, select the corresponding device "OPC UA Client" from the device drop-down bar.



- (6) Click on the address, pop up a pop-up window, select the corresponding label variable, and support label search function at the position in the figure.

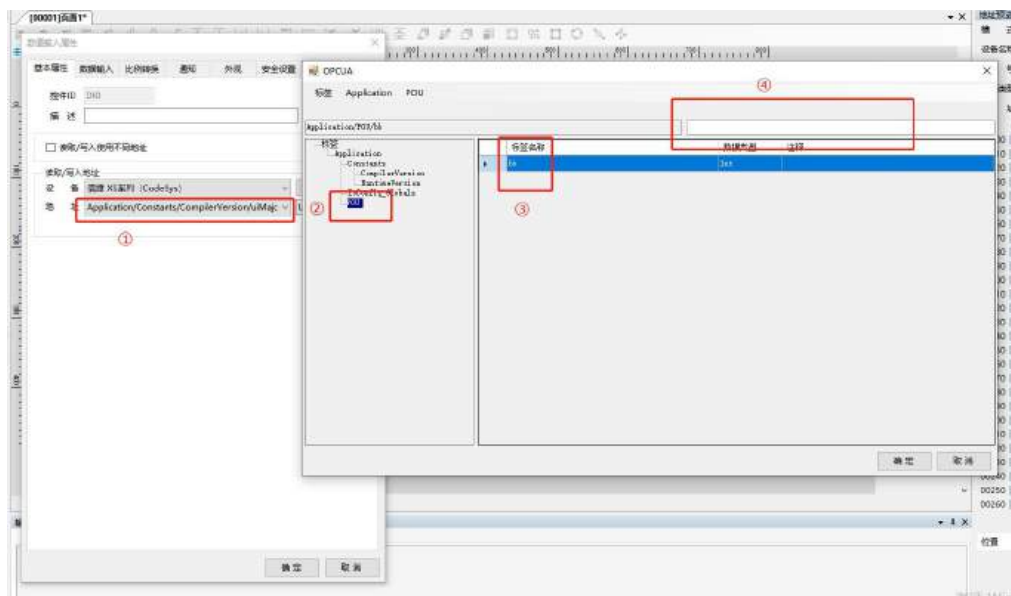

- (7) The search and deletion of tags can be found and deleted in the library address tag library device tag section.

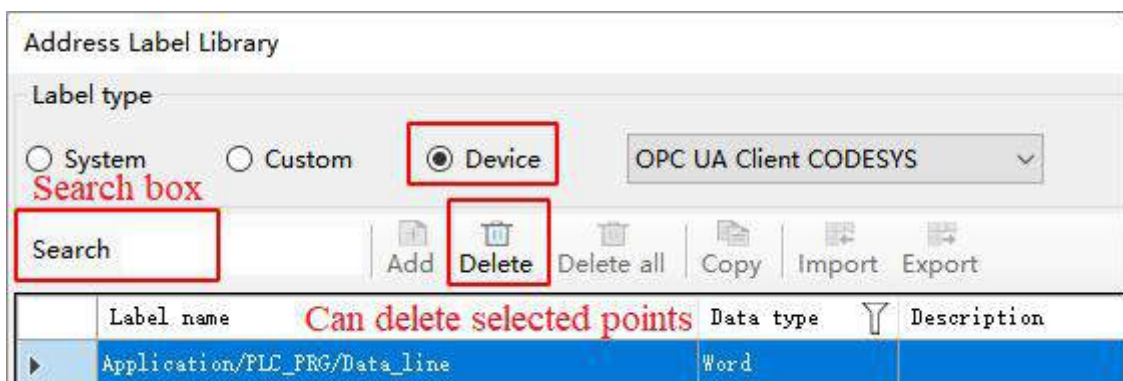
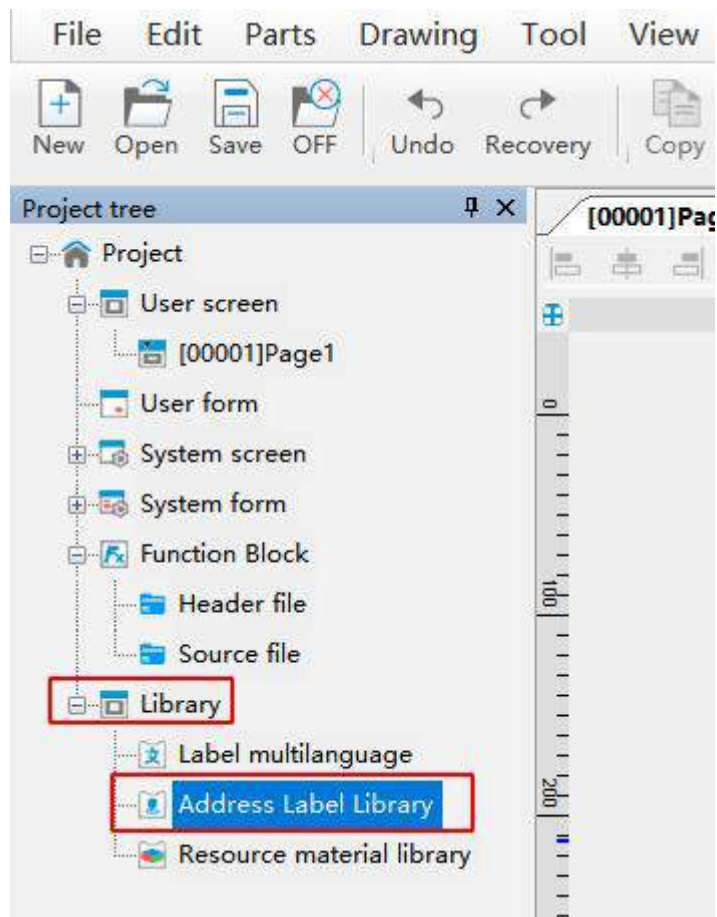

### 20.1.3 Cable making

RJ45 Straight Through Cable (connected to HUB) or RJ45 Crossover Cable :

Pin no.	Color		Pin no.	Color
1	White orange	—————	1	White orange
2	orange	—————	2	orange
3	White green	—————	3	White green
4	blue	—————	4	blue
5	White blue	—————	5	White blue
6	Green	—————	6	Green
7	White brown	—————	7	White brown
8	Brown	—————	8	Brown

( Fig1 )

Pin no.	Color		Pin no.	Color
1	White orange	—————	1	White green
2	orange	—————	2	Green
3	White green	—————	3	White orange
4	blue	—————	4	blue
5	White blue	—————	5	White blue
6	Green	—————	6	orange
7	White brown	—————	7	White brown
8	Brown	—————	8	Brown

( Fig 2 )

## 20.1.4 Support data types

### Standard Data Type

Data categories	Data type	Keywords	Bit	Notes
Bool	Bool	BOOL	1	
Integer	Byte	BYTE	8	
	Word	WORD	16	
	Double word	DWORD	32	
	Long word	LWORD	64	
	Short int	SINT	8	
	Unsigned short	USINT	8	
	Integer	INT	16	
	Unsigned int	UINT	16	
	Double int	DINT	32	
	Unsigned double integer	UDINT	32	
Real number	Long int	LINT	64	
	Real number	REAL	32	
Real number	Long real number	LREAL	64	
	String	STRING	8*N	ASCII decoding

### Standard Extended Data Type

Data categories	Data type	Keywords	Bit	Notes
String	Wide byte string	WSTRING	16*(N+1)	Unicode decoding

### User-Defined Data Types

Data type	Notes
Array	Supports up to 3D arrays
Structure	Supports all basic data types
Structure array	Support
Combination	Support

---

# 21 Codesys series PLC Connection Instructions

This chapter mainly introduces the connection instructions between the touch screen and Codesys PLC equipment.

**Note:**

- ( 1 )The Xinje TS series touch screen supports a maximum baud rate of 187.5K.
- ( 2 )During communication, please don't plug or unplug cables with power, as it may cause damage to the device's serial port.
- ( 3 )Upgrade of touch screen software version, there may be some changes in the communication protocol device address range. The device address range in the software shall prevail.

## 21.1 CODESYS PLC series——MODBUS RTU/MODBUS TCP protocol

### 21.1.1 Device type

This chapter mainly takes the Xinje XS3 series PLC as an example to conduct MODBUS RTU/MODBUS TCP protocol communication.

Series	Connected module	Port	Cable making	PLC model in Touchwin software
XS3	CPU RS232 port	RS485/232	Fig1/2	MODBUS RTU/TCP ( HMI is Master )

### 21.1.2 MODBUS RTU Parameters

#### 1. HMI settings

Parameter	Recommend settings	Choices of settings	Note
PLC type	Modbus RTU( HMI is Master )		None
Port	RS485/232		
Data bit	8		
Stop bit	1		
Parity	Even parity		
Baud rate	9600	9600/19200	
Station No.	1	1~255	

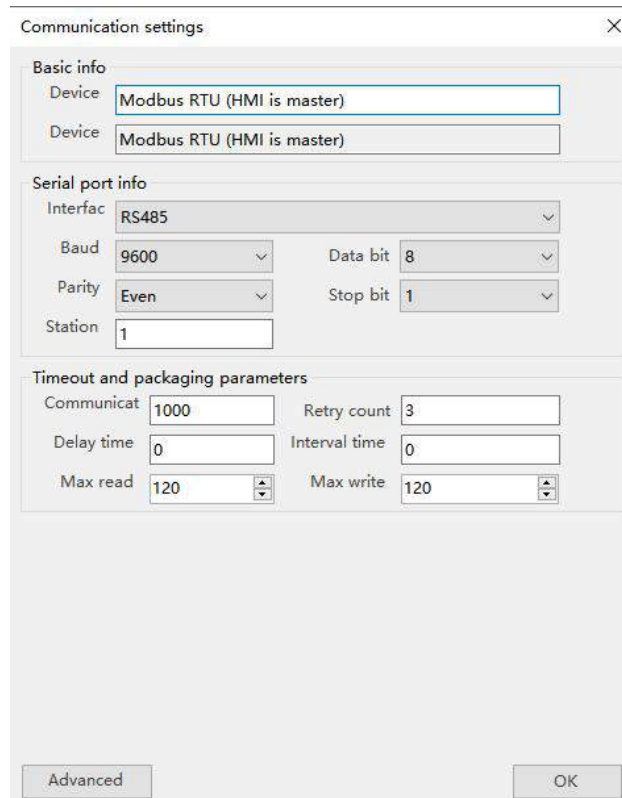

## 2. XS3 series PLC communication parameters

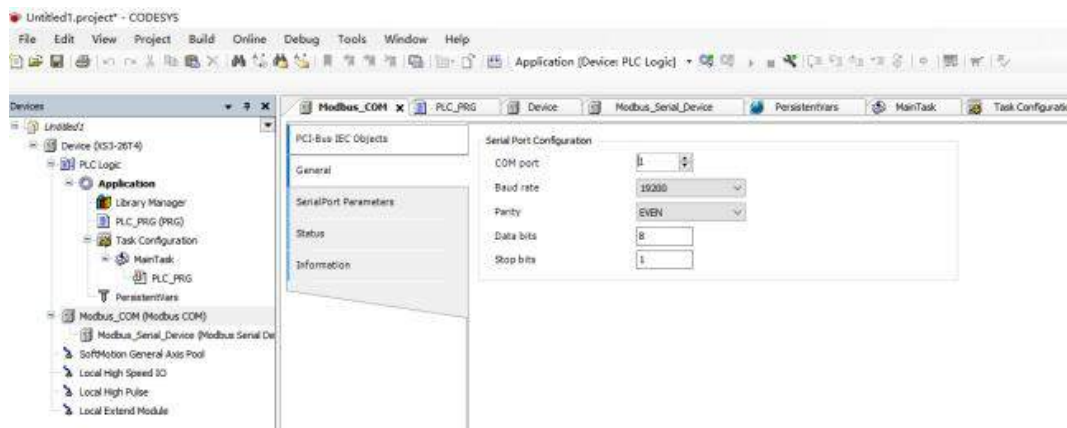

Define variables:

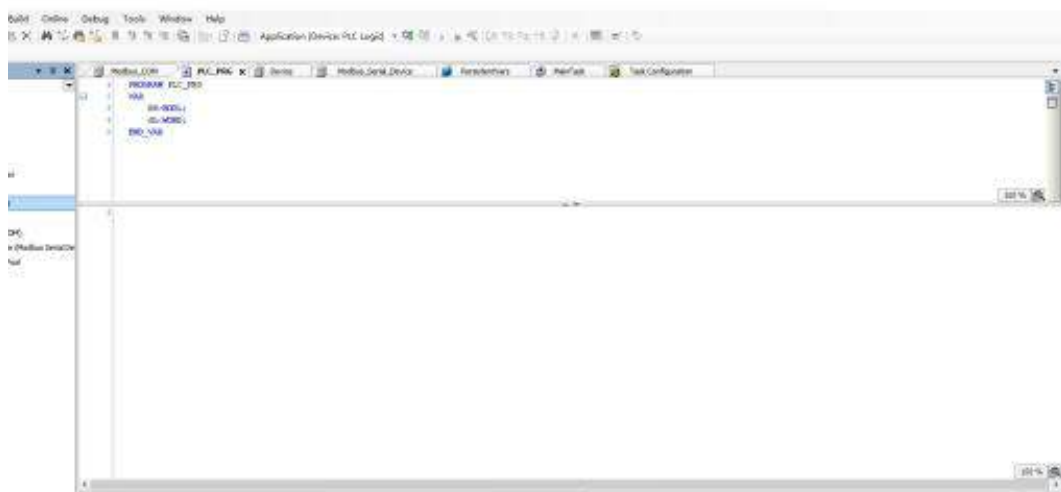

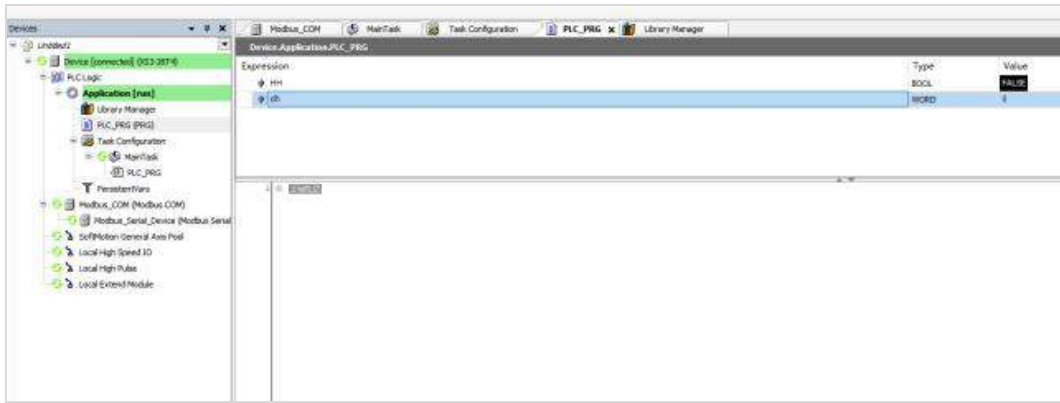

**Note:** Pay attention to the starting address range of the variable.

### 21.1.3 MODBUS TCPParameters

#### 1. HMI Parameters

Series	Port	Cable making	PLC model in Touchwin software
XS3	RJ45	Fig 3	MODBUS TCP

Set the corresponding touch screen IP address:

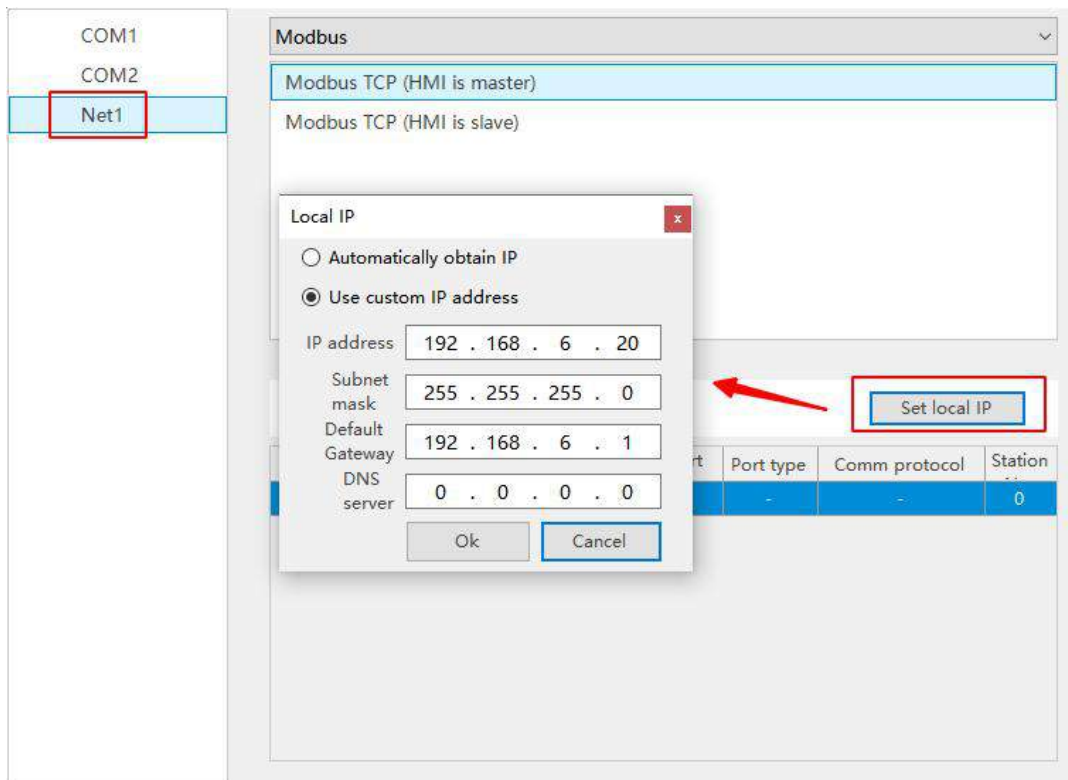

Set the IP address of the slave station, that is, the IP address of the PLC:

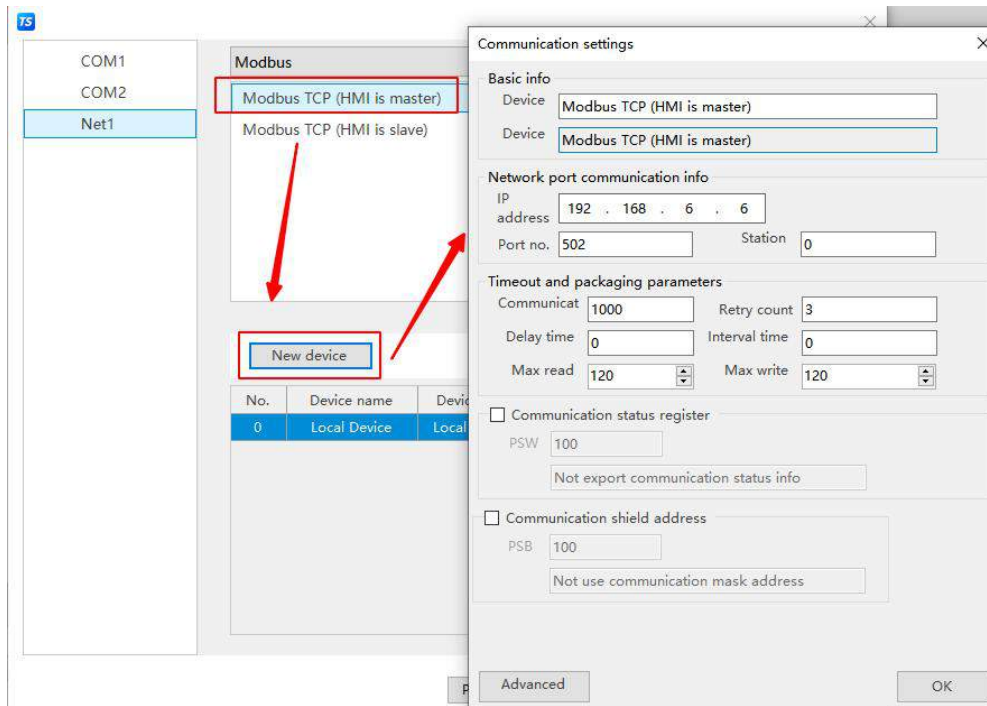

## 2. PLC Parameters

Create a new MODBUS TCP device and set the corresponding IP, as well as the number of variable addresses.

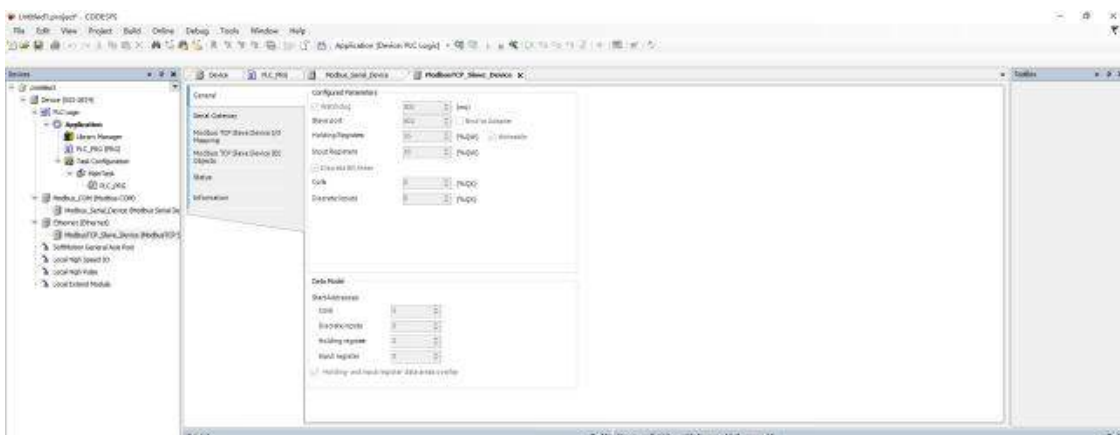
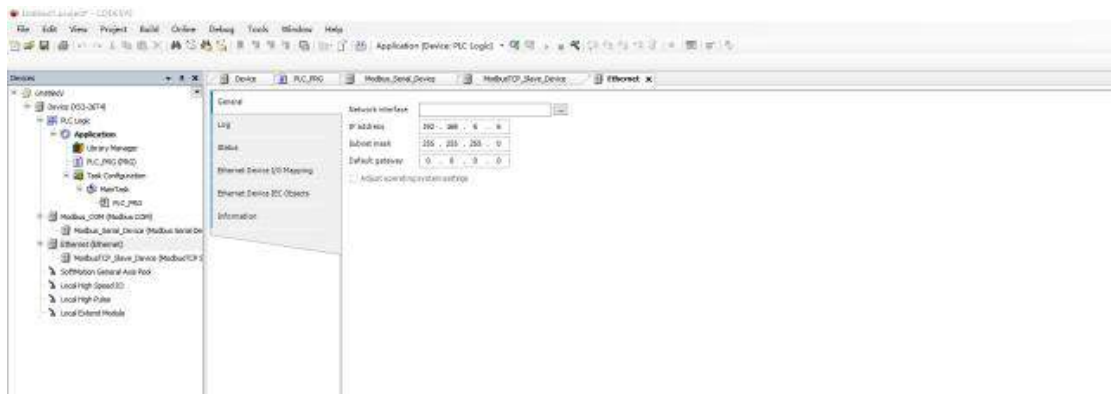

Assign the edited variable to the corresponding address and log in to communicate.

**Note:** In touch screen engineering, the station number of Ethernet devices must be 0.

### 21.1.4 Cable making

#### 1. RS485 communication line:

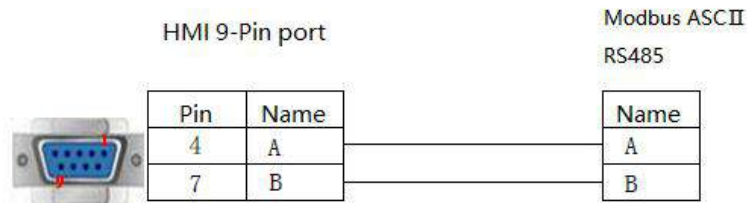

( Fig1 )

#### 2. RS232 communication line:

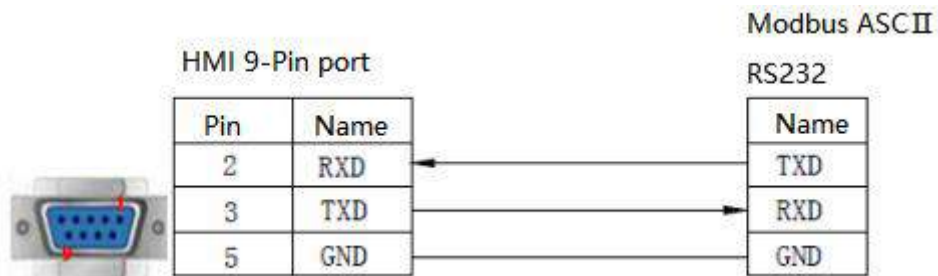

( Fig 2 )

#### 3. RJ45 Straight Through Cable (connected to HUB) or RJ45 Crossover Cable :

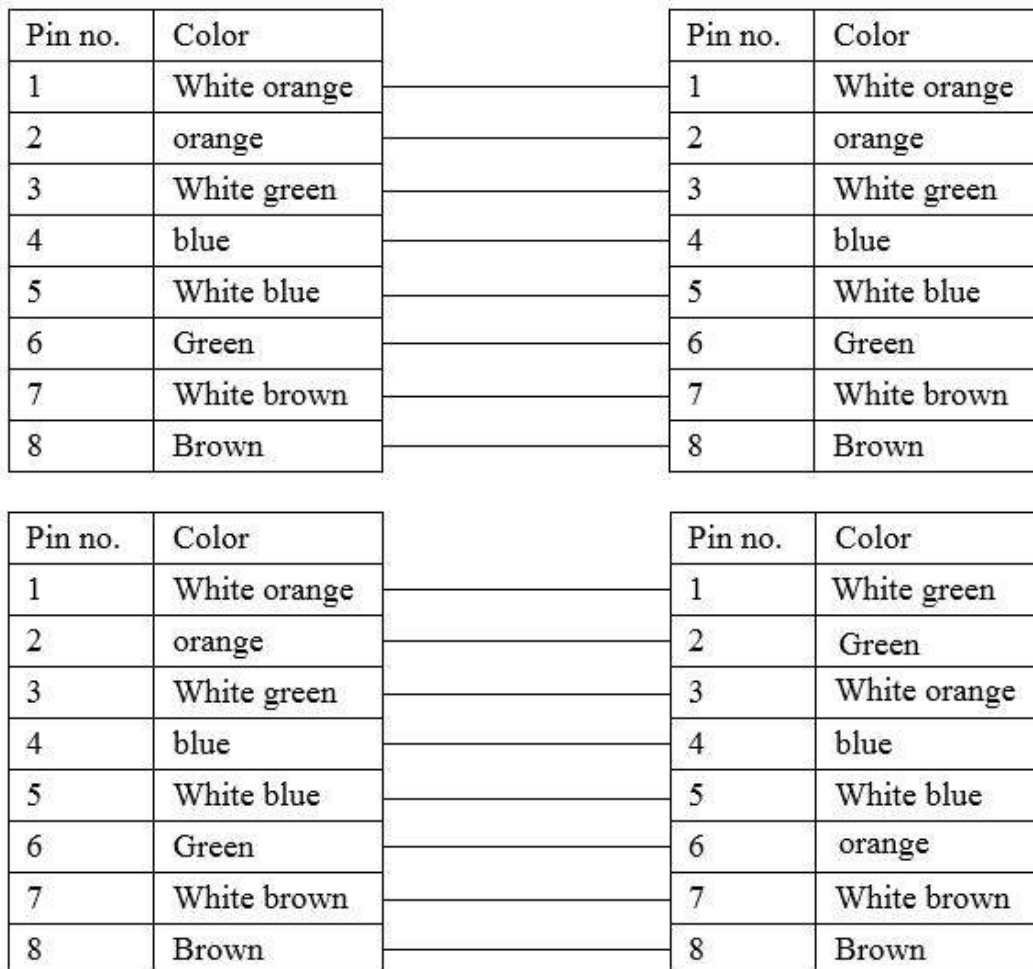

( Fig 3 )

## 21.2 CODESYS PLC series——Label communication

### 21.2.1 Device type

Support devices	Port	Cable making	PLC model in Touchwin software
Controller developed based on Codesys	RJ45	Fig 1 or Fig 2	CODESYS V3 (PLC Handler)

### 21.2.2 Parameters

Taking XSDH series PLC as an example, use the Xinje XS Studio software to explain the communication settings of the Xinje XS series (Codesys) protocol equipment.

#### 1. PLC settings:

- (1) Open the XS Studio software to create a new project, select the standard project, and select the XSDH-60A32 model. After completing the selection, click OK and pay attention to the file storage location. The XML file will be generated in this folder in the future.

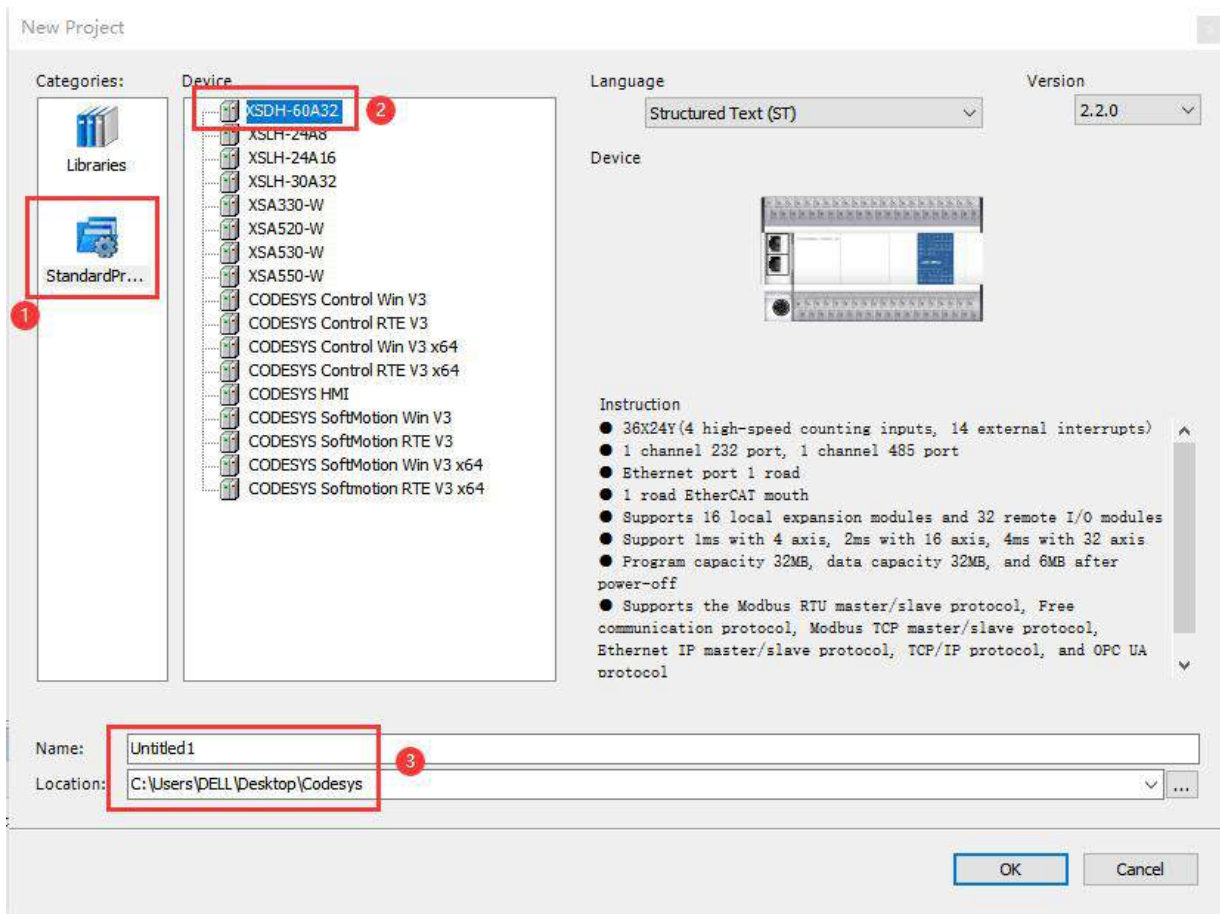

- (2) Add variables to PLC, taking the example of adding variables to a new POU: right-click on Application - Add Object - POU.

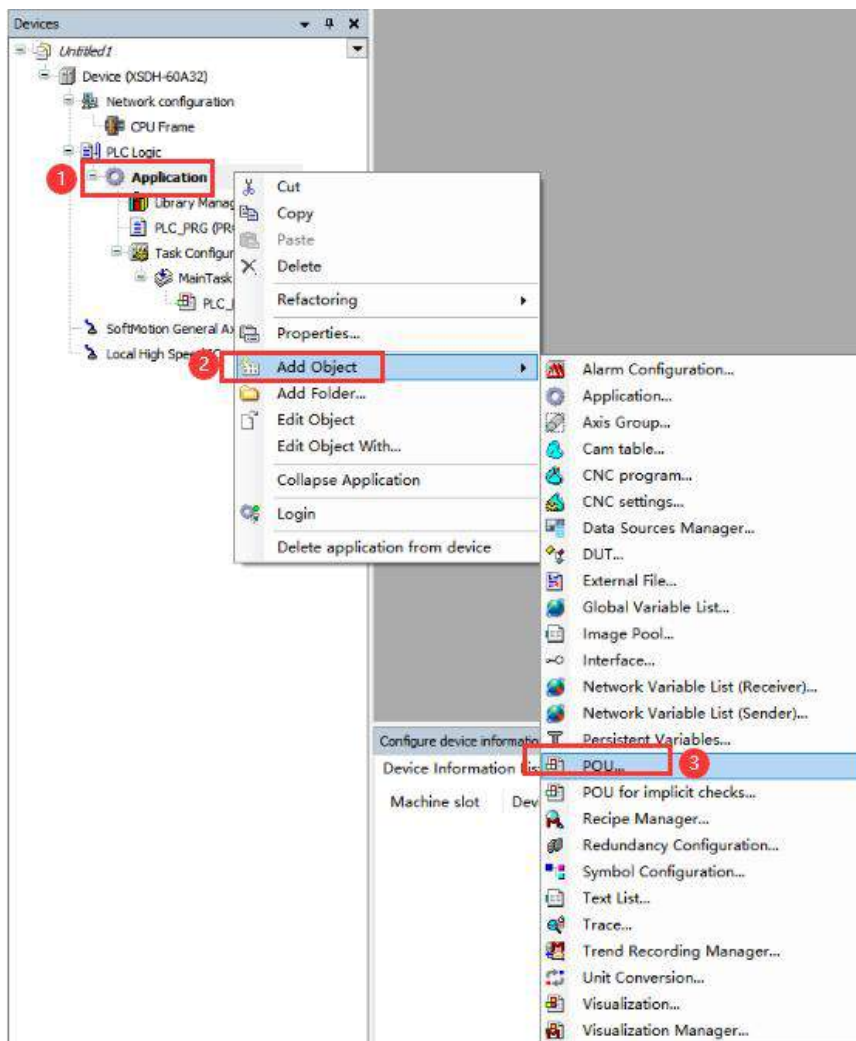

- (3) Taking the example of adding variables to POU to create BOOL type variables aa and INT type variables bb, the current supported data types are shown in [2.4.4](#). After creation, click compile.

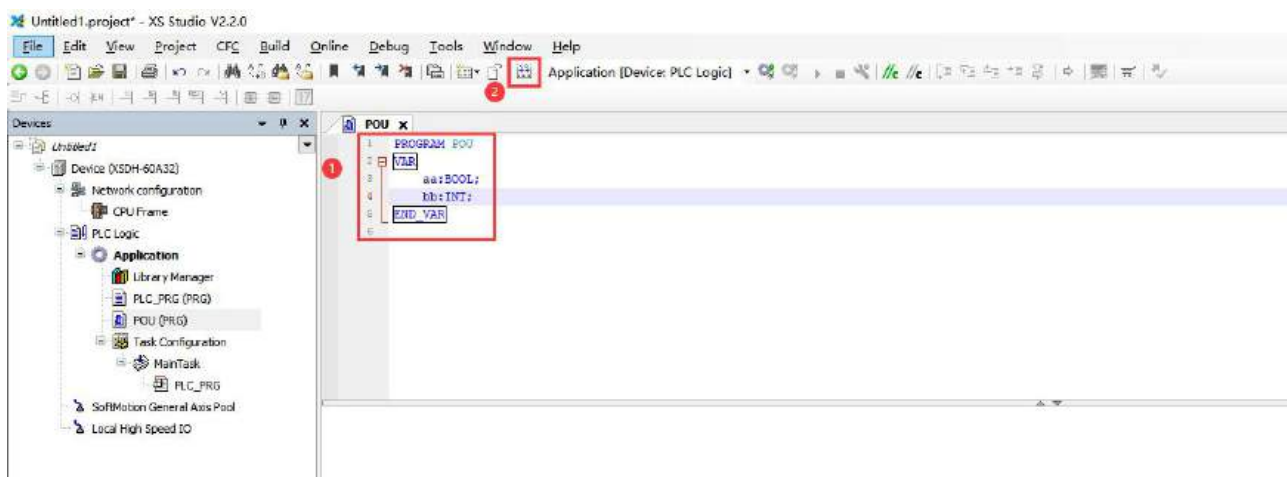

- (4) Right click on Application - Add Object - Symbol Configuration.

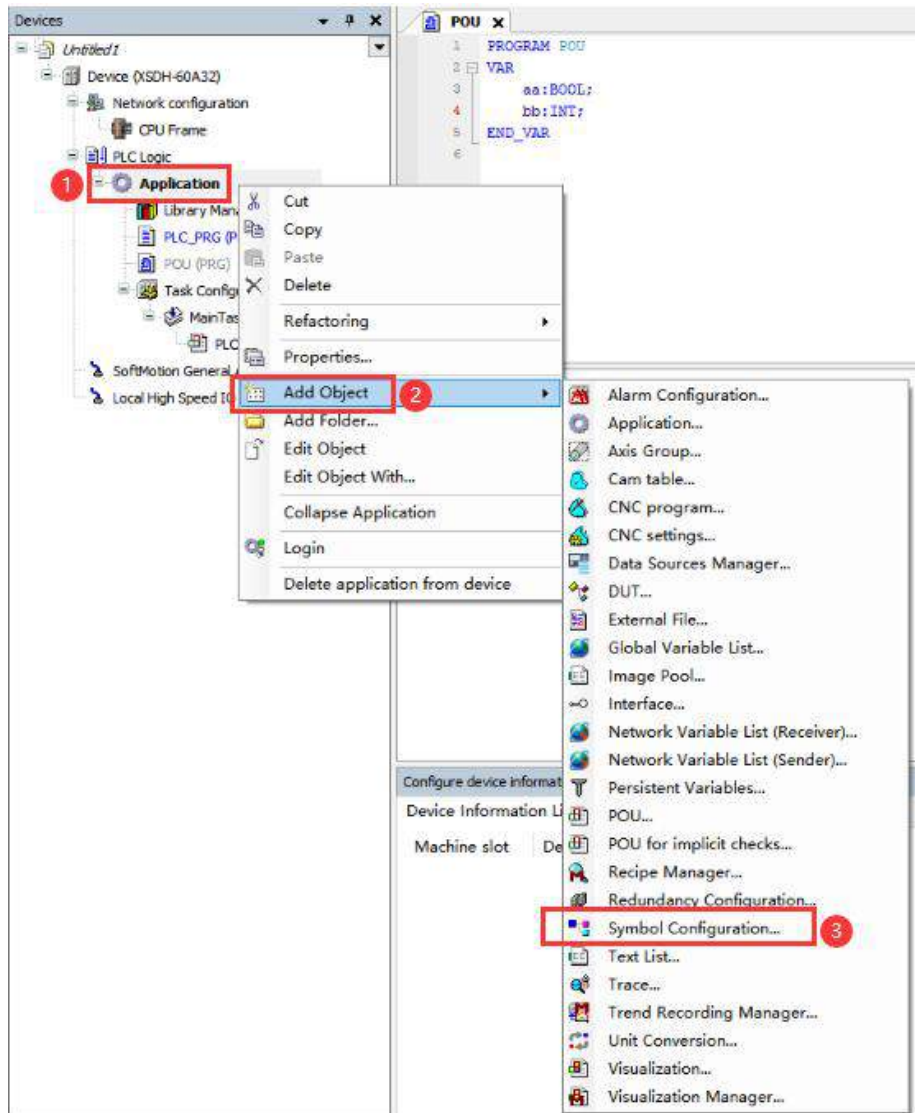

(5) Click to open, check all options, click compile.

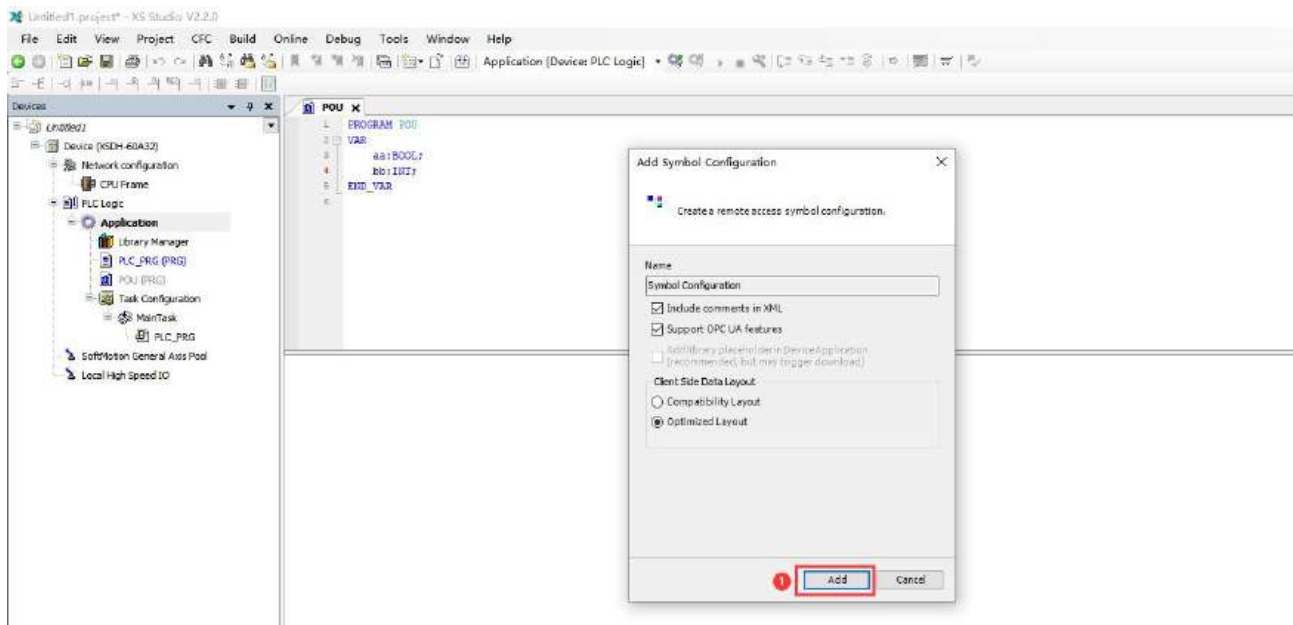

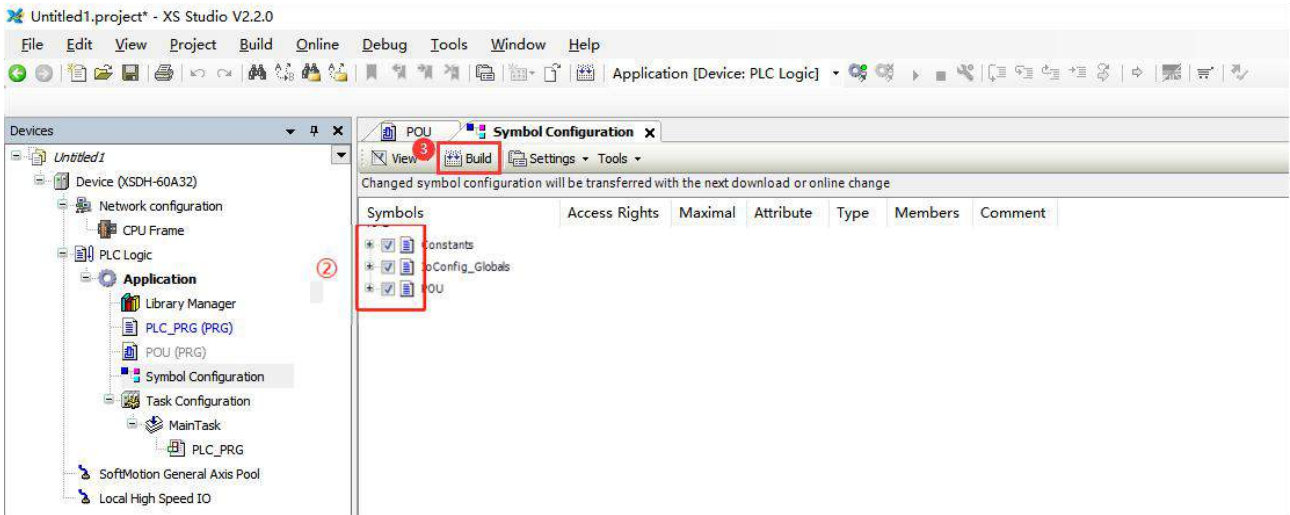

(6) Log in to the PLC and download the program. At this time, the corresponding XML file will be automatically generated in the corresponding directory of the program creation.

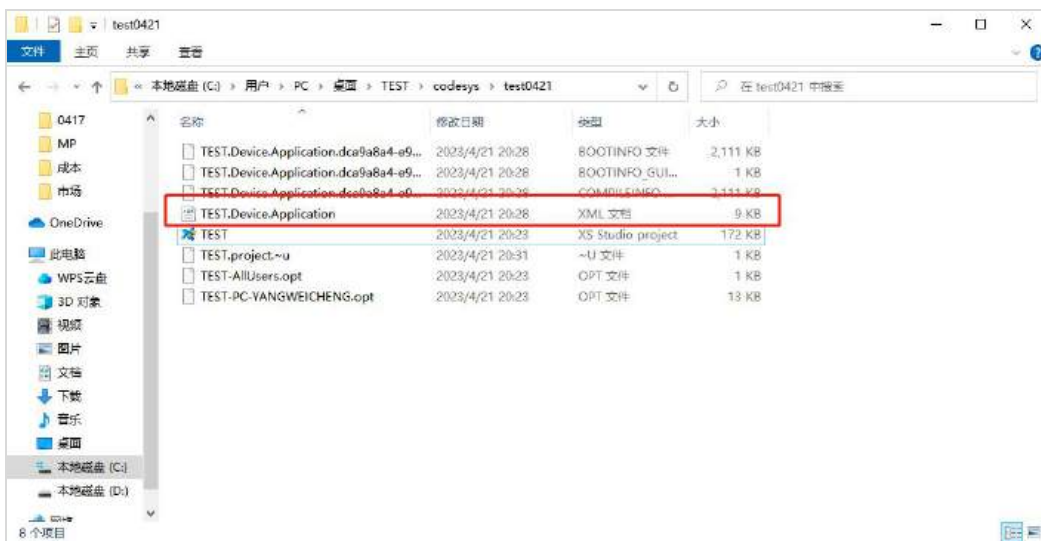
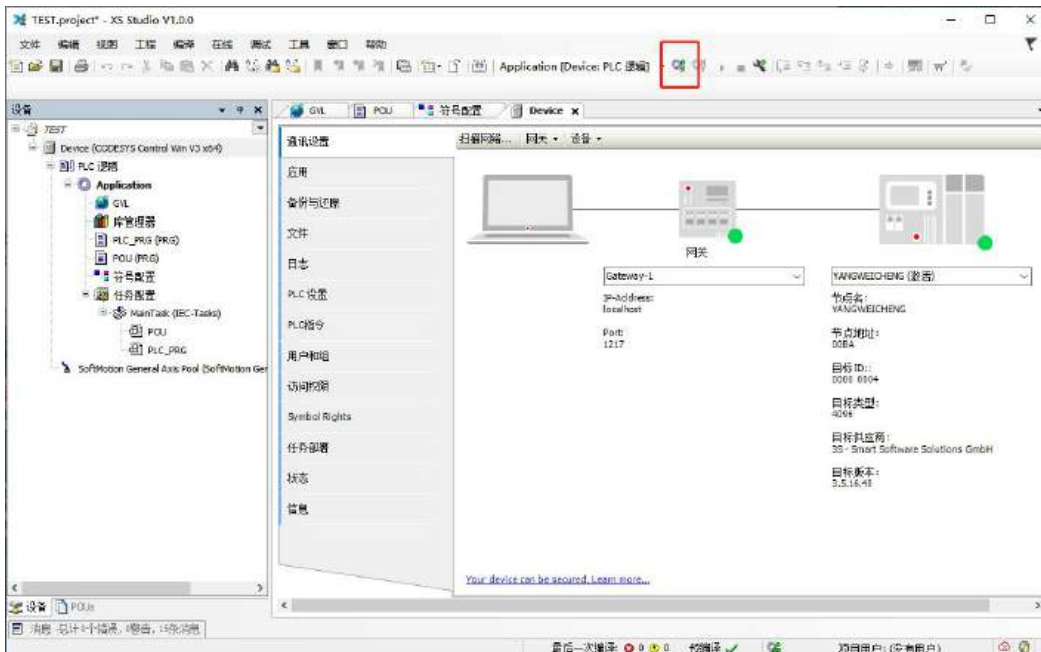

## 2. HMI settings

- (1) After selecting the human-machine interface model as - E, click to enter the next step, select "Net1" in the device list, and in "Set Local IP", IP address: the IP address of the human-machine interface, as long as it doesn't conflict with other IPs in the network. In this example, the IP of the PLC is 192.168.6.6, and the device itself can be set to 192.168.6.2.

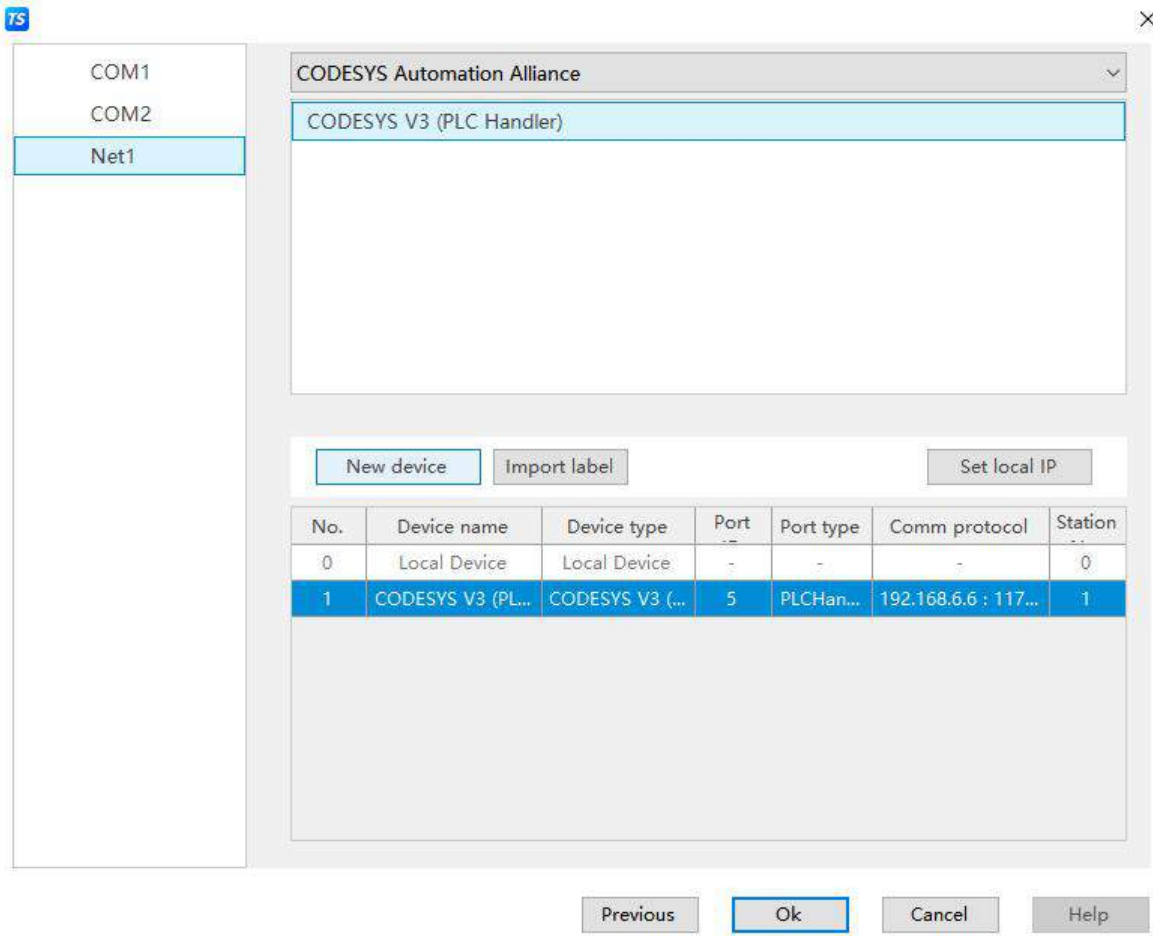

- (2) Click the drop-down button, select "CODESYS Automation Alliance" from the brand list, click the mouse to select "CODESYS V3 (PLC Handler)", then select "New Device", and set communication parameters such as device name and IP in the pop-up communication settings window. This IP address is the IP address of the PLC. After setting, click "Confirm".

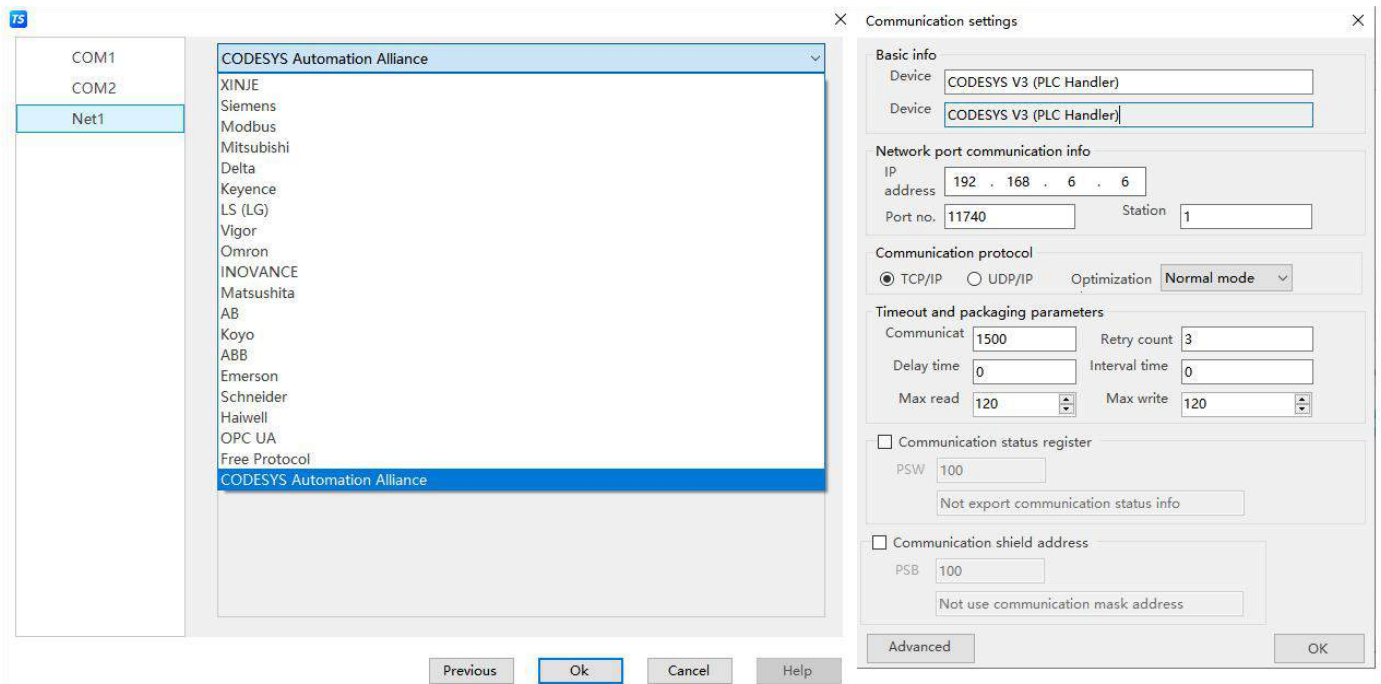

Project	Notes
Communication Protocol	TCP/IP: Based on TCP communication. UDP/IP: Based on UDP communication. By default, TCP mode is used for higher reliability. When there is a high demand for speed, it can be switched to UDP mode.
Optimization plan	Normal mode: Single channel mode, with read priority higher than write. Write optimization: Single channel mode, with write priority higher than read. Dual channel mode: occupying two sets of channels, with independent priority for reading and writing. The default is normal mode, which can be set when there are special requirements for communication speed. When one machine has multiple screens, please pay attention to cooperating with PLC to allocate channels. The specific channel configuration can be viewed on the PLC end (External input coilchannelinfo in the PLC shell).

- (3) Check the "Communication Status Register" and PSW is set to 100 by default. PSW100~PSW103 represent the number of successful communication attempts, communication failures, communication timeouts, and communication errors, respectively. Customers can set this communication status register themselves.



- (4) Click on the import tag, select the folder where the tag was created, and select the corresponding tag. A window will pop up for successfully importing xx tags. Click on close:

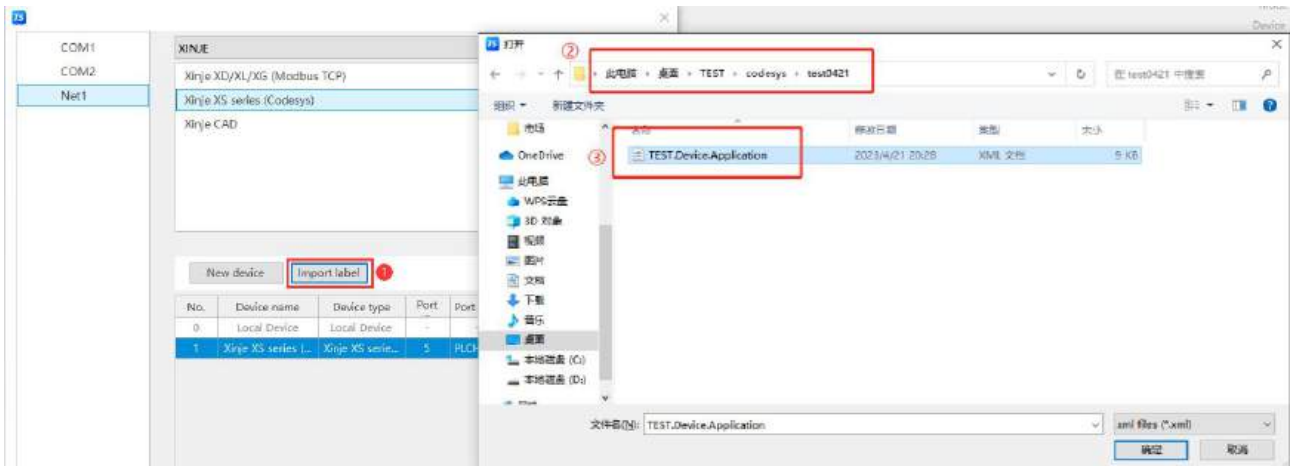

- (5) After clicking OK to complete the settings, click "Confirm" to end the settings and enter the screen editing interface. Place a numerical input component on the screen, select the corresponding device "Xinje XS Series (CodeSys)" from the device drop-down bar.



- (6) Click on the address, a pop-up window will pop up, select the corresponding label variable, and support label search function at position 4 in the figure.

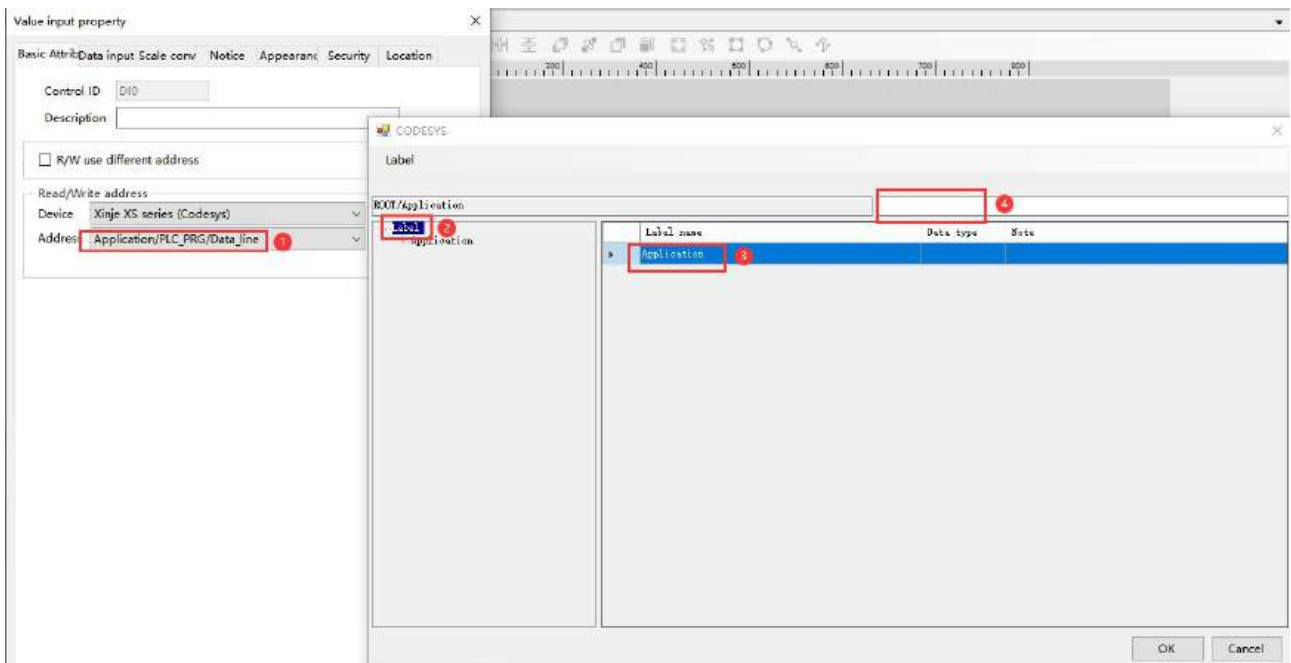

- (7) The search and deletion of tags can be done in the library address tag library device tag section.

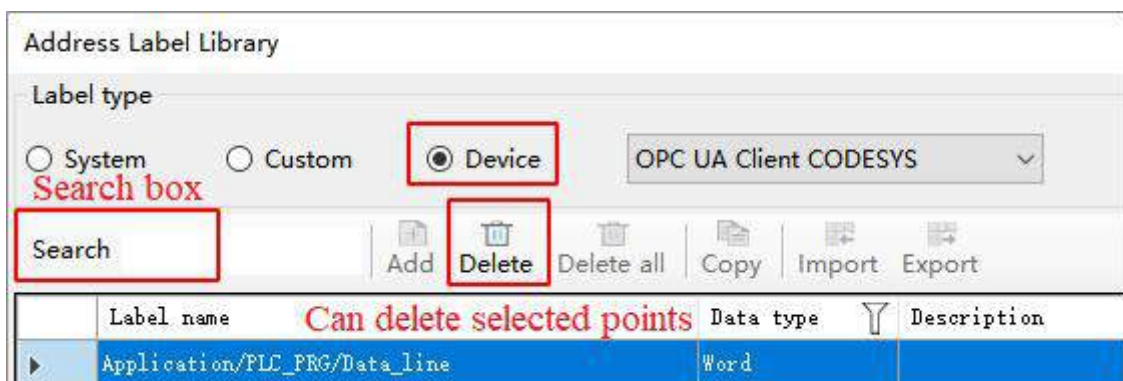
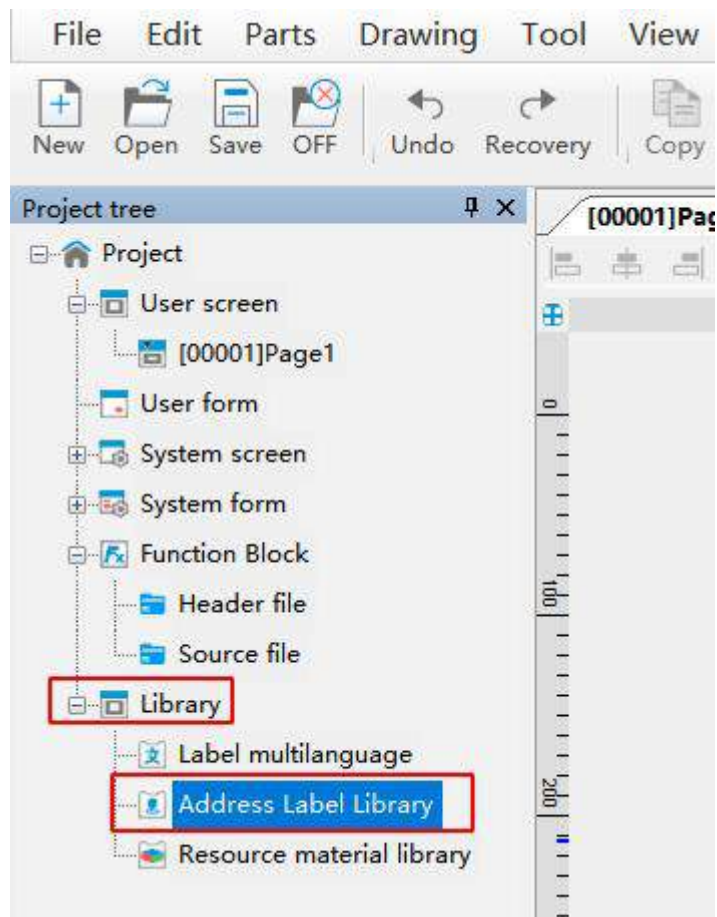

### 21.2.3 Cable making

RJ45 Straight Through Cable (connected to HUB) or RJ45 Crossover Cable :

Pin no.	Color		Pin no.	Color
1	White orange	—————	1	White orange
2	orange	—————	2	orange
3	White green	—————	3	White green
4	blue	—————	4	blue
5	White blue	—————	5	White blue
6	Green	—————	6	Green
7	White brown	—————	7	White brown
8	Brown	—————	8	Brown

( Fig1 )

Pin no.	Color		Pin no.	Color
1	White orange	—	1	White green
2	orange	—	2	Green
3	White green	—	3	White orange
4	blue	—	4	blue
5	White blue	—	5	White blue
6	Green	—	6	orange
7	White brown	—	7	White brown
8	Brown	—	8	Brown

( Fig 2 )

## 21.2.4 Support data types

### Standard Data Type

Data categories	Data type	Keywords	Bit	Notes
Bool	Bool	BOOL	1	
Integer	Byte	BYTE	8	
	Word	WORD	16	
	Double word	DWORD	32	
	Long word	LWORD	64	
	Short int	SINT	8	
	Unsigned short	USINT	8	
	Integer	INT	16	
	Unsigned int	UINT	16	
	Double int	DINT	32	
	Unsigned double integer	UDINT	32	
Real number	Long int	LINT	64	
	Real number	REAL	32	
	Long real number	LREAL	64	
String	String	STRING	8*N	ASCII decoding

**Note:** Added support for word extraction and framing.

### Standard Extended Data Type

Data categories	Data type	Keywords	Bit	Notes
String	Wide byte string	WSTRING	16*(N+1)	Unicode decoding

### User-Defined Data Types

Data type	Notes
Array	Supports up to 3D arrays
Structure	Supports all basic data types
Structure array	Support
Combination	Support



**XINJE**

WUXI XINJE ELECTRIC CO., LTD.

---

No.816, Jianzhu West Road, Binhu District, Wuxi City, Jiangsu Province, China

Tel: 86-0510-85134139

Fax: 86-0510-85111290

[www.xinje.com](http://www.xinje.com)

Email: [fiona.xinje@vip.163.com](mailto:fiona.xinje@vip.163.com)