

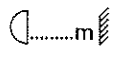



	V	P.F.	IP	IK	EN 62471	IEC/TR 62778	
	9,5kg	0,19mq	0,03mq	220-240V 50/60Hz	$\geq 0,95$	IP66	IK08(*)	Risk exempt		

(*) Escluso connettore
 (*) Connector excluded
 (**) META
 (***) META 150

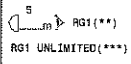
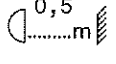
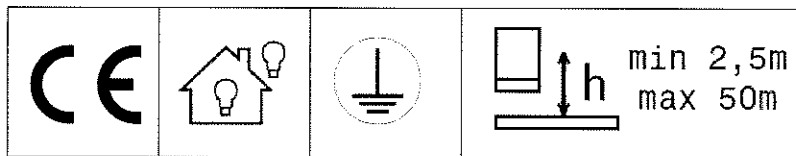

META									
Ta max (°C)	No. LED	Iled (mA)	Pmax (W)	Iac (A)	Ta max (°C)	No. LED	Iled (mA)	Pmax (W)	Iac (A)
 +40°C -30°C	9	300	35	0,17	 +55°C -30°C	9	300	35	0,17
		900	102	0,47			700	79	0,36
	12	300	46	0,22		12	300	46	0,22
		900	134	0,61			700	104	0,48
	15	300	56	0,31		15	300	56	0,31
		900	166	0,76			700	128	0,60
	18	300	68	0,34		18	300	68	0,34
		900	202	0,93			700	153	0,71

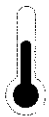
META 150														
Ta max (°C)	No. LED	Iled (mA)	Pmax (W)	Iac (A)	Ta max (°C)	No. LED	Iled (mA)	Pmax (W)	Iac (A)	Ta max (°C)	No. LED	Iled (mA)	Pmax (W)	Iac (A)
 +40°C -30°C	84	300	39	0,18	 +50°C -30°C	84	300	39	0,18	 +60°C -30°C	84	300	39	0,18
		900	115	0,53			800	102	0,47			600	77	0,36
	112	300	51	0,24		112	300	51	0,24		112	300	51	0,24
		900	152	0,70			800	134	0,62			600	100	0,46
	140	300	63	0,31		140	300	63	0,31		140	300	63	0,31
		900	188	0,87			800	168	0,78			600	117	0,56
	168	300	75	0,36		168	300	75	0,36		168	300	75	0,36
		900	223	0,99			800	199	0,93			600	139	0,66

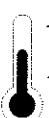
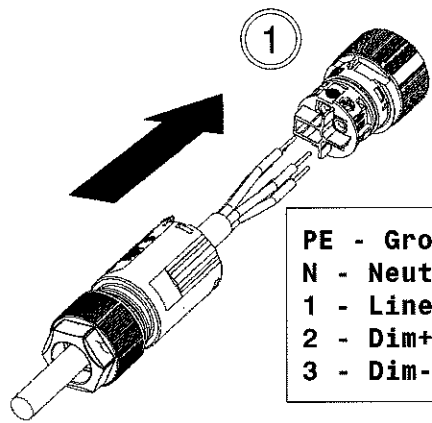

1

- PE - Ground
- N - Neutral
- 1 - Line
- 2 - Dim+/DALI+
- 3 - Dim-/DALI-

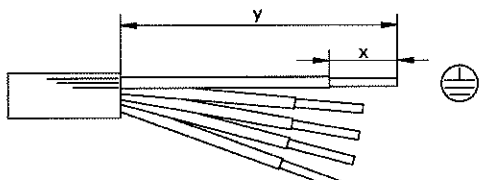

	PE	N,1,2,3
X	8mm	8mm
Y	33mm	25mm

Sezione conduttore 0,25 - 1,5 mm²
 Rated cross-section 0,25 - 1,5 mm²

0,5Nm

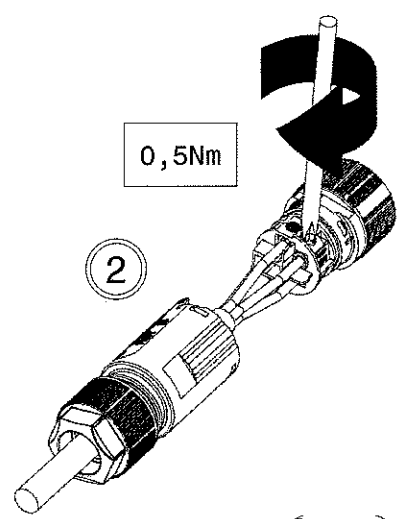

2

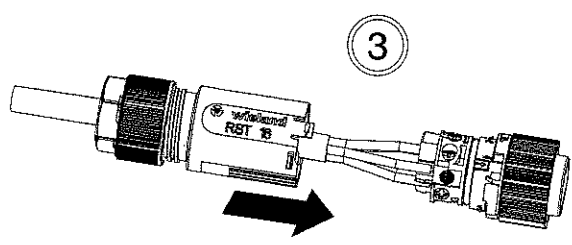

3

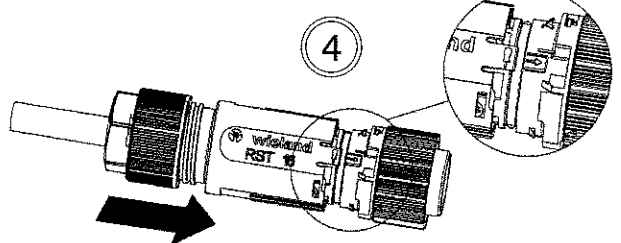

4

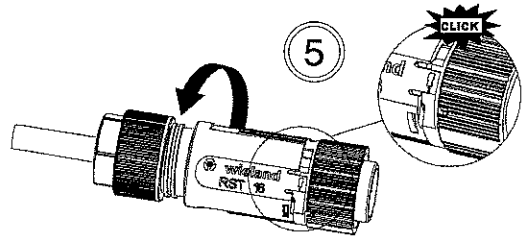

5

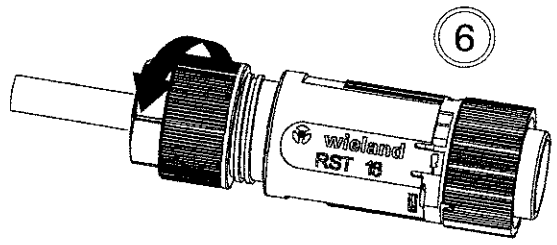
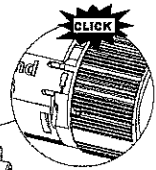

6

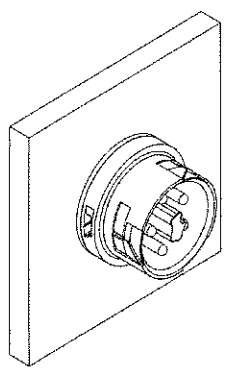

7

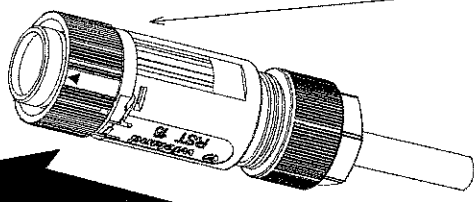

CLICK

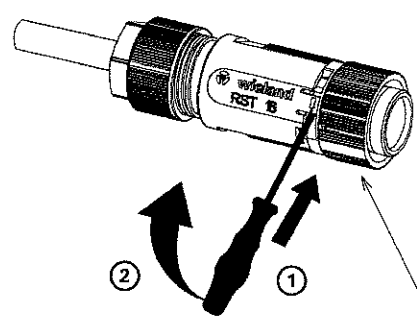
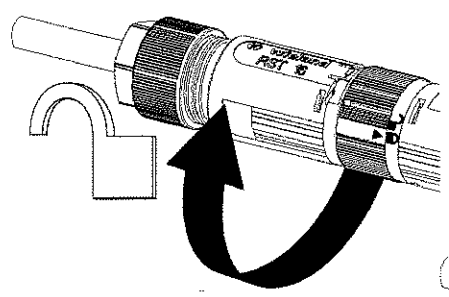
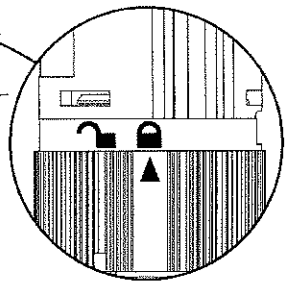

2

1

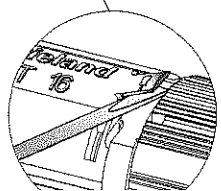
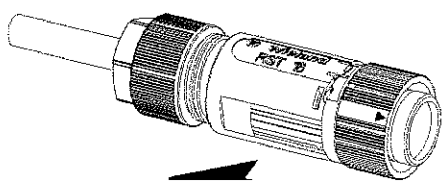

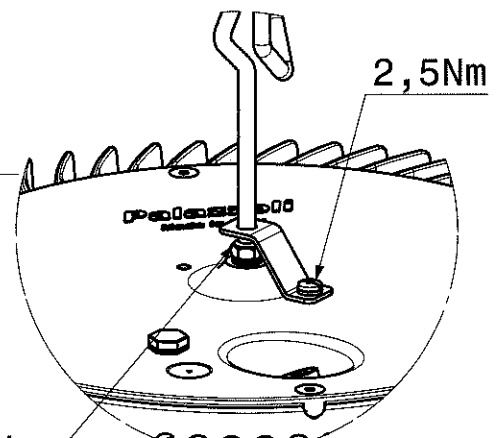
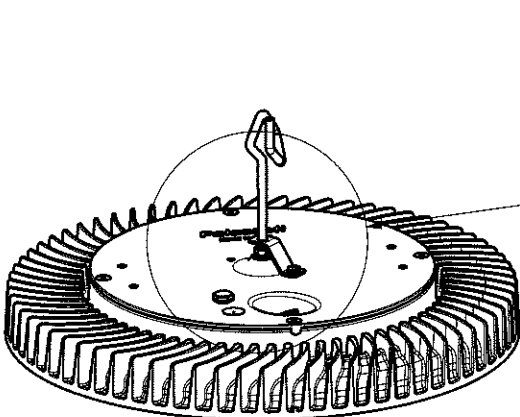
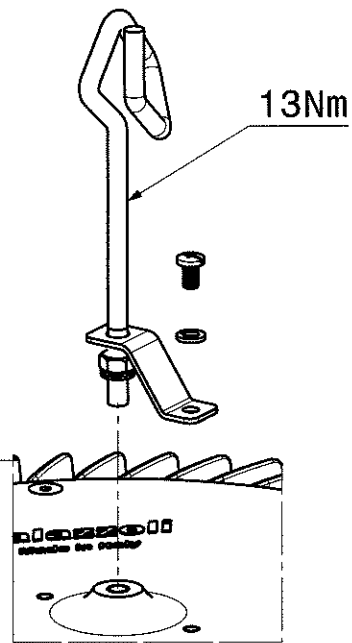
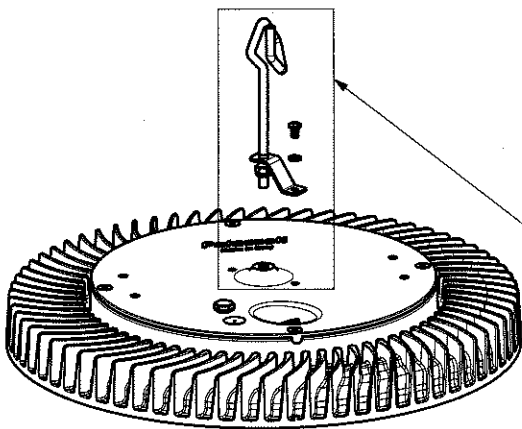
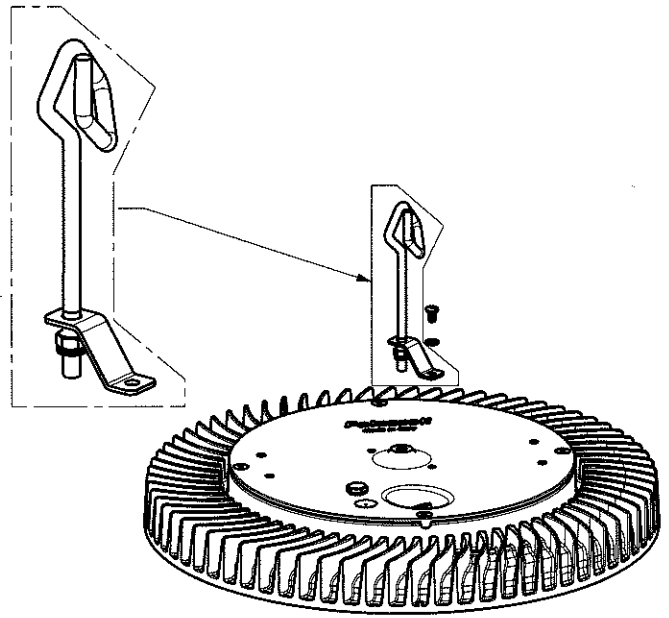
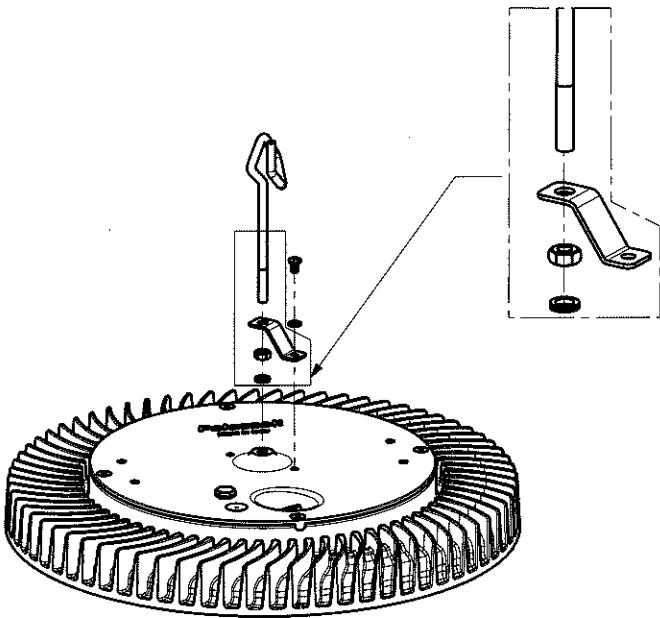

CH13 - 15Nm

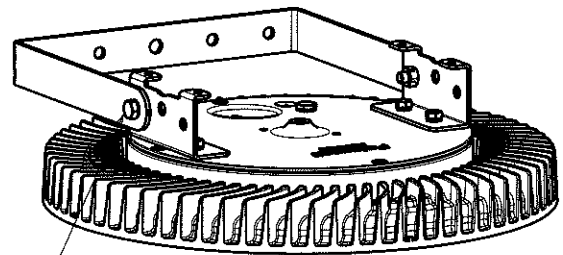
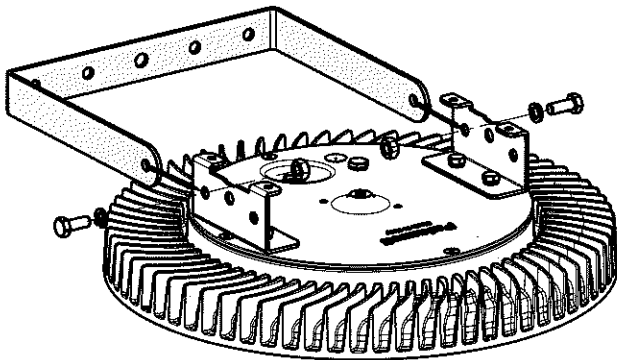
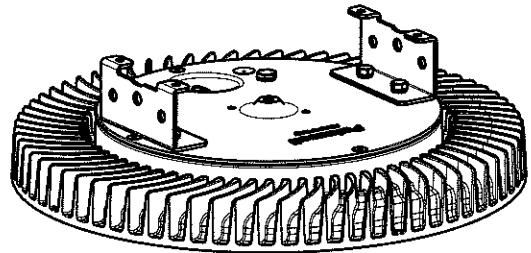
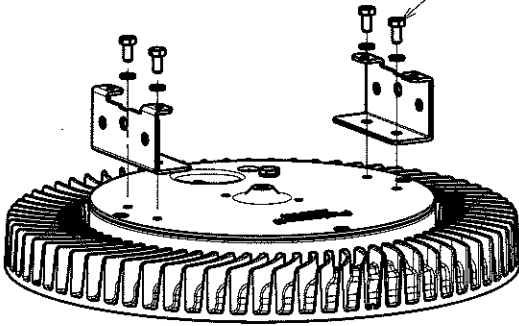

CH16 - 30Nm

META SOSPENSIONE ELLITTICA
META SUSPENSION ELLITTIC

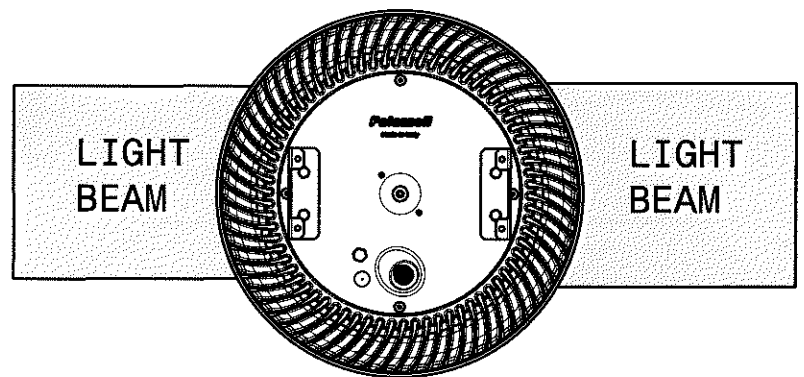

META PROIETTORE
META PROJECTOR

