

Table of Contents

1. Safety Information	1
1.1 Preparation.....	1
1.2 Symbol.....	2
1.3 Maintenance	2
2. Description	3
2.1 Part name.....	3
2.2 Rotary switch description.....	4
2.3 LCD display.....	5
3. Specification	6
3.1 Overview	6
3.2 Technical indexes	7
4. Operation guide.....	10
4.1 Reading hold	10
4.2 Backlight/Light.....	10
4.3 Automatic shutdown	11
4.4 AC & DC current measurement	11
4.5 AC & DC voltage measurement.....	12
4.6 Low-impedance measurement	13
4.7 On-off/Resistance/Capacitor measurement.....	13
4.8 Temperature measurement	13
4.9 μ A current measurement	14
4.10 NCV (Non-contact voltage detection).....	14
5. Maintenance.....	15
5.1 Change battery	15
5.2 Change pens.....	16
6. Accessories	16

1. Safety Information



Pay special attention to use of this instrument, for improper use may cause electric shock or damage to instrument. During use, observe usual safety regulations and observe safety measures regulated in use manual.

In order to make full use of instrument functions and guarantee safe operation, please carefully read and observe use methods in this manual.





Instrument complies with safety requirements on electronic measuring instrument of EN-61010-1, EN-61010-2-030 and EN-61010-2-032, level II pollution, and over-voltage standard is CAT III 1000V, CAT IV 600V.

Please observe safety operation guide, and guarantee to use instrument in a safe manner.

1.1 Preparation

- ⇒ When using this instrument, users must observe standard safety rules:
 - General electric shock prevention.
 - Prevention of misuse of instrument.
- ⇒ After receiving the instrument, check whether it is damaged during transportation.
- ⇒ After storing and shipping under adverse conditions, check whether the instrument has been damaged.
- ⇒ Pens of the instrument must be in good condition. Before use, check whether insulation of pens is damaged, and whether metal wire is exposed.

1.2 Symbol

	Note (refer to use manual for important safety information)
	Able to be used on dangerous electrified conductors.
	Dual-insulation protection (Category II)
CAT III CAT IV	Over-voltage according to IEC-61010-1 standard (installation), level III, IV pollution degree 2 refers to protection level of pulse withstand voltage provided.
CE	Comply with EU standard.
	Grounded

1.3 Maintenance

- ⇒ Do not try to open bottom case to adjust or repair instrument, for such operation could only be conducted by technicians fully understanding the instrument and electric shock danger.
- ⇒ Before opening instrument bottom case or battery cover, remove the pens from the wire being measured.
- ⇒ In order to avoid electric shock possibly caused by error reading, when symbol "" displays on instrument, replace battery immediately.
- ⇒ Use wet cloth and gentle detergent to clean the instrument, and do not use any abrasive or solvent.
- ⇒ Power off when the instrument is not used, and rotate range switch to OFF position.
- ⇒ If the instrument is not used for a long time, take out the battery to avoid any damage to the instrument.

2. Description

2.1 Part name

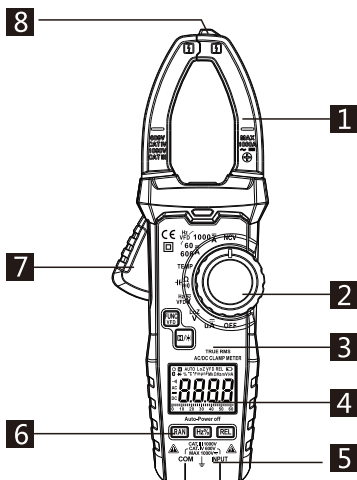

- 1** Current clamp: Used in current measurement
- 2** Rotary switch
- 3** Function key
- 4** Liquid crystal display (LCD)
- 5** Input socket
- 6** Function key
- 7** Trigger
- 8** Non-contact voltage detecting & inducing area

2.2 Rotary switch description

$A \approx$	AC & DC current measurement
TEMP	Temperature measurement
$\pm (\frac{\Omega}{\text{cap}})$	Capacitor, on-off and resistance measurement
$\frac{\text{Hz}}{\text{VFD}} \approx$	AC/DC voltage measurement
$\frac{\text{LoZ}}{\text{V}}$	Low-impedance voltage measurement
$\mu\bar{\bar{A}}$	DC μA current measurement
OFF	Instrument OFF

2.3 LCD display

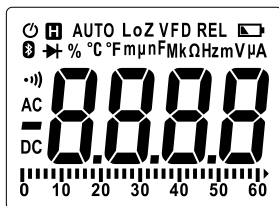

~ ≡	AC & DC
•)))	Connection/Disconnection indication
AUTO	Automatic range mode
⏻	Automatic shutdown indication
🔋	Low battery
⏸	Reading hold state
V, A, μ A	Volt (voltage), ampere (current)
Ω , k Ω , M Ω	ohm, kilohm and megohm (resistance)
Hz, kHz ,	hertz, kilohertz
VFD	Variable frequency measurement
μ F	Microfarad
$^{\circ}$ C $^{\circ}$ F	Centigrade and Fahrenheit
LowZ	Low-impedance measurement mode
%	Duty ration measurement
REL	Relative measurement

3. Specification

The instrument specifies one year as a cycle, and shall be re-calibrated under 18°C ~ 28°C, with relative humidity less than 75%.

3.1 Overview

- Select measurement function and range automatically.
- Overload protection throughout the range.
- Max. voltage between measurement terminal and ground: 1000V DC or 1000V AC
- Operating height: Max. 2000m
- Display: LCD
- Max. display value: 6000 digit.
- Polarity indication: Automatic indication, and '-' indicates negative.
- Over range display: '0L' or '-0L' .
- Sampling time: About 3 times/second., bargraph 10 times/second
- Unit display: Function and electricity quantity unit display.
- Automatic shutdown time: 10 minutes
- Power supply: 1.5V AAA battery × 3
- Battery under-voltage indication: LCD display symbol 
- Temperature coefficient: Less than 0.1×accuracy/°C.
- Operating temperature: 18°C ~ 28°C.
- Storage temperature: -10°C ~ 50°C.

3.2 Technical indexes

3.2.1 AC current

Range	Resolution	Accuracy
60A	0.01A	± (2.5% reading + 8 digits)
600A	0.1A	
1000A	1A	

- Min. input current: 0.1A AC current.
- Max. input current: 1000A AC current.
- Frequency range: 45 ~ 65Hz;

3.2.2 DC current

Range	Resolution	Accuracy
60A	0.01A	± (3% reading + 10 digits)
600A	0.1A	
1000A	1A	

- Min. input current: 0.01A DC current
- Max. input current: 1000A DC current

3.2.3 DC voltage

Range	Resolution	Accuracy
6V	0.001V	± (0.5% reading + 5 digits)
60V	0.01V	
600V	0.1V	
1000V	1V	

- Min. input voltage 0.001V DC
- Max. input voltage: 1000V DC

3.2.4 AC voltage

Range	Resolution	Accuracy
6V	0.001V	±(0.8% reading + 5 digits)
60V	0.01V	
600V	0.1V	
1000V	1V	±(1.0% reading + 5 digits)

- Min. input voltage: 0.001V AC
- Max. input voltage: 1000V AC (valid value)
- Frequency range: 45 ~ 1000Hz

3.2.5 Frequency /Duty cycle

3.2.5.1 Clamp frequency measurement (via gear A):

Range	Resolution	Accuracy
100Hz	0.01Hz	± (1.0% reading +5digits)
1000Hz	0.1Hz	
10kHz	0.001kHz	
1%~99%	0.1%	± (3.0% reading +2 digits)

- Measurement range: 10Hz ~ 10kHz
- Input signal range: ≥ 30A AC current (valid value)

3.2.5.2 Via gear V:

Range	Resolution	Accuracy
100Hz	0.01Hz	± (1.0% reading +5digits)
1000Hz	0.1Hz	
10kHz	0.001kHz	
1%~99%	0.1%	± (3.0% reading +2 digits)

- Measurement range: 10Hz ~ 10kHz
- Input signal range: ≥ 0.8V AC voltage (valid value)

3.2.6 Resistance

Range	Resolution	Accuracy
600 Ω	0.1 Ω	\pm (1.0% reading +3digits)
6k Ω	0.001k Ω	
60k Ω	0.01k Ω	
600k Ω	0.1k Ω	
6M Ω	0.001M Ω	
60M Ω	0.01M Ω	\pm (1.2% reading +30digit)

- Overload protection: 250V DC or AC (valid value)

3.2.7 Line on-off test

Range	Resolution	Function
•))	1 Ω	If resistance of the line being measured is less than 30 Ω , buzzer in instrument will make continuous alarming sounds.

- Overload protection: 250V DC or AC (valid value)

3.2.8 Capacitor

Range	Resolution	Accuracy
60.00nF	0.01nF	\pm (4% reading + 3 digits)
600.0nF	0.1nF	
6.000uF	1nF	
60.00uF	10nF	
600.0uF	100nF	
6.000mF	1 μ F	
60.00mF	10 μ F	

- Overload protection: 250V DC or AC (valid value)

3.2.9 Temperature

Range	Resolution	Accuracy
-20~1000°C (-4~1832 °F)	1°C/2°F	± (1% reading +2 digits)

- Overload protection: 250V DC or AC (valid value)

3.2.10 μA Current

Range	Resolution	Accuracy
200.0uA	0.1uA	± (0.8% reading +3 digits)



- Overload protection n: 250V DC or AC (valid value)

4. Operation guide

4.1 Reading hold

During measurement, if it is required to hold reading, touch button, value on display will be locked, touch  button again, to cancel reading hold.

4.2 Backlight/Light

- ◆ During measurement, if environment light is too dark, causing it difficult to read, you could press  key for more than 2 seconds, to open backlight or light, which will turn off in about 1 min. automatically.
- ◆ During this period, if press  key for more than 2 seconds, it will turn off backlight.

4.3 Automatic shutdown

- ◆ If there's no operation within 10 minutes after start, instrument will enter standby state, and shut down to save energy.
- ◆ After automatic shutdown, press any key, to wake the instrument enter work state.

4.4 AC & DC current measurement

Turn rotary switch to AC current range and hold trigger, open clamp, and clip one lead of the line being measured in clamp, instrument will display measured current, press FUNC key to select AC or current measurement, and press RAN key to select range manually, during AC current measurement, press Hz% key to shift display between frequency and duty ration of measured current. Long press FUNC key to start VFD measurement function.

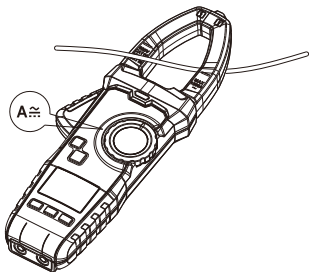

4.5 AC & DC voltage measurement

Turn rotary switch to AC & DC voltage, press FUNC key to shift between AC and DC voltage measurement modes, connect pens to the signal being measured, with red pen connected to positive of the signal being measured, and black pen connected to negative of the signal being measured. During AC voltage measurement, press Hz% key to shift display between frequency and duty ratio of measured voltage. Long press FUNC key to start VFD measurement function.

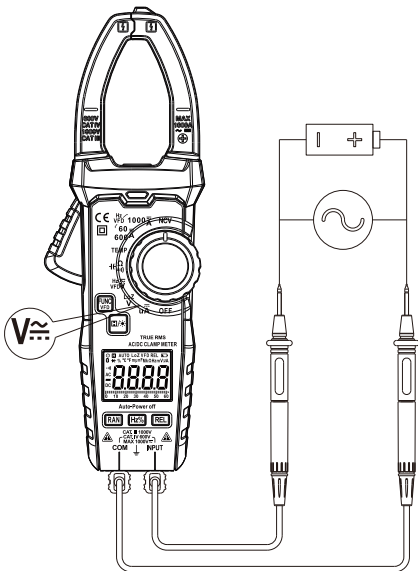

4.6 Low-impedance measurement

Turn rotary switch to LowZ, press FUNC key to shift between AC and DC voltage measurement modes, and connect pens to the signal being measured.

Note: In low-impedance measurement mode, the longest measurement time shall not be larger than 1 min.

4.7 On-off/Resistance/Capacitor measurement

Turn rotary switch to resistance and capacitor, press FUNC key to shift between on-off, resistance and capacitor functions; when pens are connected to the resistance being measured, instrument will display measured resistance, when measured value is less than 30Ω , instrument buzzer will alarm.

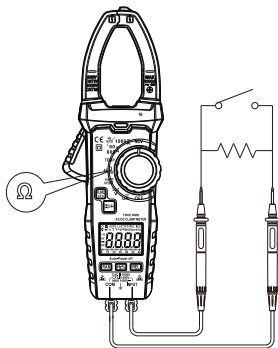

4.8 Temperature measurement

Turn rotary switch to TEMP, insert probe of thermocouple into socket, with positive of the probe connected to red input terminal. Primary display will show Centigrade of measured temperature, and press FUNC key to display Fahrenheit of measured temperature.

4.9 μ A current measurement

Turn rotary switch to μ A, and connect pens to the signal being measured in series. Primary display will show measured current.

4.10 NCV (Non-contact voltage detection)

Turn rotary switch to NCV, instrument will display EF, and close NCV detector to the lead being measured, instrument could detect whether the lead being measured is >90 V AC voltage. When instrument detects AC voltage, instrument buzzer will alarm and NCV alarm light will flash.

Note:

Even if there's no alarm indication, voltage may still exist. Do not depend on non-contact voltage detector to judge whether there's voltage in the lead. Detection operation may be impacted by factors like different socket designs and insulation thickness types etc.

5. Maintenance

5.1 Change battery



Before opening battery cover of the instrument, remove the pens from the circuit being measured, to avoid electric shock.

- 1 If symbol "  " appears, it indicates to change the battery.
- 2 Unfasten bolts on battery cover of instrument and remove the cover.
- 3 Change the old battery.
- 4 Place the battery cover.

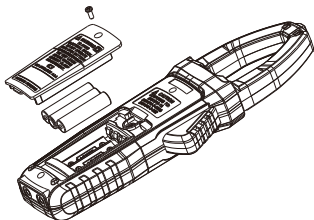

5.2 Change pens



When changing the pen, it is required to replace with an identical pen or a pen of the same level. The pen must be in good condition, and level of the pens is: 1000V 10A.

If insulation layer of the pen is damaged, or metal wire of the lead exposes, it is required to change the pen.

6. Accessories

① Pens	Level: 1000V 10A	1
② Use Manual		1
③ Battery	1.5V AAA battery	3
④ Cloth bag		1
⑤ K-Type		1